

Safety Components



Up-to-date price list:
www.automationdirect.com/pricelist

FREE Technical Support:
www.automationdirect.com/support

FREE Videos:
www.automationdirect.com/videos

FREE Documentation:
www.automationdirect.com/documentation

FREE CAD drawings:
www.automationdirect.com/cad



Safety components are part of a larger system that protect your personnel

Factory equipment automation can be deemed a critical application, yet it is clear that properly designing the safety aspect is even more crucial. This has typically meant applying safety components to the fundamental automation system. The purpose of a safety system is to bring a machine to a safe state as quickly as possible if a safety sensor is triggered, an e-stop pushbutton is activated, or any other safety-related anomaly is detected.

The first step is to perform a risk assessment following methods outlined in various industry standards. Potential unsafe conditions must be identified, along with ways for bringing the equipment to a safe state.



Most often, a safe state is achieved by removing sources of energy such as electricity but sometimes mechanisms must be engaged to slow or lock the equipment, or power may need to be maintained to hold the equipment in a safe state.



There are options for the heart of a machine safety system, most notably basic safety relays or safety controllers such as the ReeR MOSAIC.

In addition to the heart of the safety system, there are many other components such as safety switches and safety light curtains that can be used to break a failsafe circuit connected to the safety control system as well as other specialized components that not only electrically interlock within a safety circuit but lock a gate or physical guard such as a solenoid locking interlock switch. Other options include operator interfaces such as two-hand control stations, safety laser area scanners, safety mats and edges and bumpers to protect personnel from pinch points or mobile equipment.

Whether you decide to use a simple safety relay or a sophisticated safety controller, such as the ReeR MOSAIC; need a light curtain or just a replacement safety interlock switch AutomationDirect has what you need.



Why buy safety components from AutomationDirect?

There are several advantages to buying safety components from AutomationDirect. In addition to quality products from manufacturers such as ASO, IDEM, Dold, ReeR, Contrinex and Datalogic, we also offer:



Free 2-day delivery for orders over \$49* **See Terms and Conditions for exceptions.*



Price

As with all of our product lines, our prices are often well below the list prices of traditional automation suppliers. Our direct business model allows us to operate more efficiently than other suppliers and pass the savings on to you.



Availability

All of the safety components that we provide are stocked in one of our local warehouses in Georgia. That's correct, when we say we have them in stock, they are in our inventory and ready to be shipped to you. No more waiting for months when you need a replacement component that is keeping your facility from operating.



Service

We give you options for self-service but at the same time, we are there when you need us. You can place your order online or call our customer service team. Have a technical question about one of our products or need help gathering up a bill of materials for one of your projects? You can call our free Technical Support. Although we cannot perform a risk assessment or audit of your facility, our knowledgeable technical support experts can help you with product selection and configuration or wiring if you get stuck or just have a question.

A large selection of safety light curtains to protect your equipment from any angle

ReeR Safegate Light Curtains

ReeR Type 4 / Category 4 access control safety light curtains offer many configuration options for access control (body) protection applications. We offer standard non-muting units as well as units with built-in configurable muting capabilities. Active/passive pairs reduce wiring by only requiring one side to be wired. Many muting accessories available as well as columns and mirrors that work specifically with the ReeR safety light curtains.



Prices start at \$980.00 for sender/receiver pair

- Protective height range from 810 and 910mm
- Protective distance up to 12M for sender/receiver pairs
- Available in active/passive pairs to save on wiring, protective distance up to 8M
- Non-muting and muting models available
- Muting models available as programmable and non-programmable
- Muting accessories available include basic sensors, L muting arms as well as T muting arms
- Mirror and protective columns available
- Double PNP outputs, M12 connection.
- Free configuration software for programmable models



Datalogic Light Curtains

Datalogic Type 4 / Category 4 safety light curtains offer finger (14mm resolution) or hand (30mm resolution) protection in basic or advanced models, sold in sender/receiver pairs. Basic models allow manual or automatic restart and external device monitoring. Advanced models offer additional programmable functionality including cascading, muting and blanking.



Prices start at \$551.00 for sender/receiver pair

- Protective height range from 150 to 900mm in 14mm resolution (finger protection)
- Protective height range from 300 to 1800mm in 30mm resolution (hand protection)
- Double PNP outputs, M12 connection.
- Free configuration software for advanced models

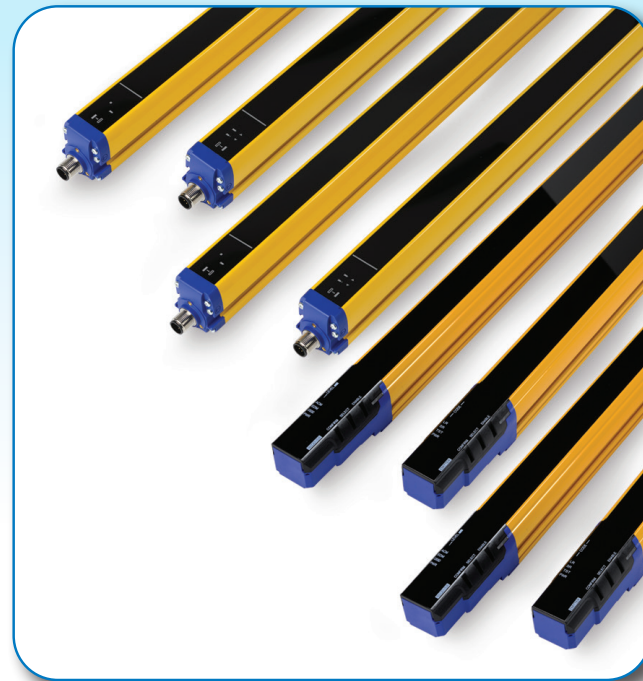

Contrinex Slim Profile Light Curtains

Contrinex Type 4 / Category 4 safety light curtains in slim body profile offer finger (14mm resolution) and hand (30mm resolution) protection in IP65 rated housings. These light curtains have a profile of 26mm x 26mm as opposed to the larger standard size Contrinex light curtain size of 42 x 48mm, reducing space requirements in tight installations. These light curtains have no blind zone for flexible installation. Wireless configuration, using Bluetooth® allows for a fast and easy setup. Senders and receivers are available as a matched set. The electrical connection is via a standard M12 quick-disconnect that allows quick installation and replacement.



Prices start at \$540.00 for sender/receiver pair

- Protective height range from 170 to 1290mm in 14mm resolution (finger protection)
- Protective height range from 170 to 1610mm in 30mm resolution (hand protection)
- Operating distance of 5.0M for both 14mm and 30mm resolution
- No blind zone
- Beam coding, EDM, start and restart interlock configurable functions
- Permanent autocontrol and optical sync
- Wireless configuration through Bluetooth®



Contrinex Light Curtains

Contrinex Type 4 / Category 4 safety light curtains offer finger (14mm resolution), hand (30mm resolution) or body (access control) protection in IP65/67 rated housings; senders and receivers can be purchased individually or as a matched set. The electrical connection is via a standard M12 quick-disconnect that allows quick installation and replacement.



Prices start at \$560.00 for sender/receiver pair

- Protective height range from 142 to 1045mm in 14mm resolution (finger protection)
- Protective height range from 279 to 1827mm in 30mm resolution (hand protection)
- Protective height range from 832 to 1232mm in 300 and 400mm resolution (access control/body protection)
- Operating distances of 3.5M (14mm resolution), 12M (30mm resolution) and 15M or 50M (300 and 400mm resolution)
- Double PNP outputs, M12 connection
- Simple hardware configuration



Light Curtain Columns and Mirrors

Mirrors for Contrinex safety curtains can allow a single pair of light curtains to protect several sides of a machine. The protective columns protect a light curtain from damage and help prevent the curtain from being knocked out of alignment. The baseplates allow for mounting and beam alignment.

Light Curtain Mirror Columns

- Multi-sided safe guarding of danger zones
- Robust protective profile
- 10% reduction of operating distance per mirror

Light Curtain Protective Columns

- Used to mount and protect Contrinex YBB, YCA and YBxS Slim series light curtains
- Robust baseplate allows radial and vertical alignment
- Solid aluminum profile



MOSAIC

MODULAR SAFETY INTEGRATED CONTROLLER

A unique safety controller that's modular, expandable and configurable for managing all safety functions of a single machine or an entire plant. MOSAIC offers cost reductions with minimal wiring.

Starting at \$376.00 - The MOSAIC Safety Controller is *extremely cost-effective* whenever two or more safety devices are required:

- Simplifies wiring
- Cross fault detection built-in
- External device monitoring (EDM) built-in
- Expandable; monitor or control up to 140 devices (124 in / 16 out)
- Supports 12 different types of safety devices

Replace individual safety relays and simplify your safety control with the MOSAIC controller and expansion modules. Expansion modules include:

- Discrete safety I/O modules (input, output, and combination)
- Analog safety input modules
- Status I/O modules
- Communications modules (EtherNet/IP and Modbus TCP)
- Speed monitoring and standstill modules, for monitoring many types of encoders or proximity sensors

REER

Connect all these devices to the controller I/O



Connection and programming examples for many common applications - [HERE](#)

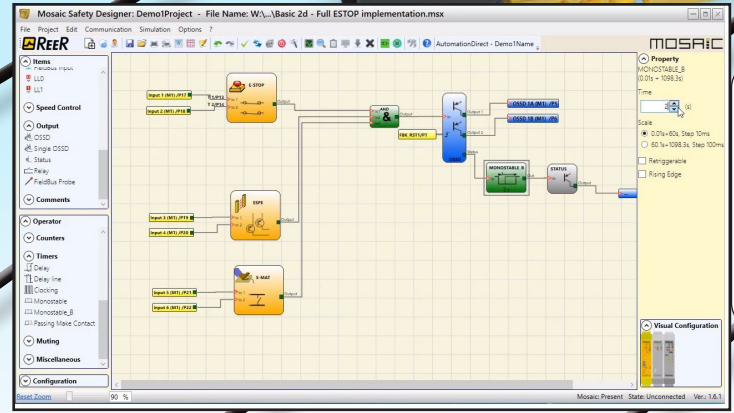

FREE Software to configure, program, simulate and monitor your safety system

- Pictorial, drag-and-drop interface
- Predefined functions
- Rules-based guidance
- Offline simulation saves costly downtime
- Generates reports to expedite safety validation



Safety Controller



safety switch



pushbutton control station



safety light curtains



safety bumper, mats and edge



two-hand control panel



encoder or proximity sensors



liquid level sensor

DATALOGIC

SAFETY LASER SCANNERS



Safety laser scanners offer an ingenious, cost-effective way to protect an entire area. This can be a static application such as a robot cell or the area surrounding a moving device such as an AGV. They are ideal for providing safe access to potentially dangerous locations or areas.

These laser area scanners are configurable and feature a 275-degree viewing window that allows for several user-defined zones of protection.

In addition to defining safety zones, these scanners support user-defined I/O and dust filtering. Prices start at \$2,102.00

- 275° viewing window
- Easy programming with intuitive GUI
- Three programmable levels of advanced dust filtering
- Can be installed to monitor either horizontally or vertically
- Configurable warning areas extend up to 40m out
- Two distinct and assignable warning signals
- Muting capability for vertically installed applications
- Three built-in I/O points, each configurable as an input or an output via GUI

Safety laser scanner accessories available include mounting brackets and replacement windows. Brackets are available that allow for adjustment of pitch and roll, pitch only and a model designed to protect the head of the scanner.



Safety Relays

These dependable relays are designed to protect people and machines in applications requiring safety interlocks and controls. Prices start at \$126.00

Types:

- Speed & standstill monitors
- E-Stop & safety gate relays
- Safety mat and bumper control
- Two-hand controllers
- Light curtain controllers
- Extension modules

Features:

- Single or dual channel operation
- Models with force guided relays (cross monitoring)
- Safety ratings up to SIL3 and PLe (application dependent)
- Monitored manual or auto start /reset
- Multiple output, auxiliary and time-delay contact options
- All Models: cULus, RoHS, CE, TUV* approvals * no TUV on BH5932 models

Two-Hand Control Systems

Two-hand control systems are used with a two-hand control monitoring relay (such as the BG5933-22-61-24) and require an operator to use both hands at the same time when initiating a hazardous operation. This forces operators to have their hands on the two-hand control actuator elements and out of the danger zone while the two-hand system is actuated.

Prices start at \$153.00

- Available fully assembled or unassembled without pushbuttons
- Available with zero-force or mechanical pushbuttons
- Available in die-cast aluminum or thermoplastic
- Wall mountable and post mountable models
- Protective guard hoods over the safety buttons to prevent operators from bypassing the safety function of the device
- Replacement pushbuttons available



Safety Enabling Switches

Enabling switches, also called "dead man's switches", in conjunction with a properly designed safety system, can provide the operator with a special mode for tasks such as maintenance or debugging. These switches consist of a spring-return three-position grip that is required to be maintained by the operator in the middle position to stay in the operating mode. Prices start at \$234.00

- Three-position spring-return grip button with N.O.-N.C.-N.O. to ensure operator is aware of function
- Ergonomic (right- or left-handed)
- Easy to operate (even when wearing gloves)
- Robust housing in IP67
- Optional increased protection against manipulation with in-hand detection
- Optional built-in E-stop, LED, pushbuttons, and activity ("home" position) sensor
- Universal connection via cable or terminals



A superb line of machine safety devices . . . at incredible prices



IDEM Non-Contact Magnetic Locking RFID Switches

The MGL Series of safety switches combines magnetic locking and radio-frequency identification (RFID) sensing technology to provide non-contact operation and anti-tamper coding. In addition, an electromagnet is used to lock machine guards.

Prices start at \$382.00

- Heavy duty or medium duty holding force models available
- Master coded or uniquely coded actuation
- RFID provides a high degree of anti-tamper, virtually impossible to override
- Flexible actuator for a high degree of misalignment tolerance
- Able to connect to most popular safety relays to achieve up to PLe and Cat.4 for ISO3849-1
- Ability to connect up to 20 switches and E-stops in series
- IP69K rating for food processing applications (stainless steel)

SSP Non-Contact Magnetic Locking RFID Switches

SSP non-contact magnetic locking safety switches offer a great value for locking switches using RFID technology that mount perfectly on T-slotted rail. They also offer enhanced diagnostics as well as Bluetooth connectivity for configuration.

Prices start at \$349.00

- Diagnostic LEDs
- Configurable over Bluetooth connection
- Perfect size for mounting on SureFrame T-slotted rails
- RFID provides a high degree of anti-tamper, virtually impossible to override
- OSSD output
- 24VDC to lock
- Master-coded or re-teachable models available
- 600N and 1200N holding force models available
- Able to connect to safety relays with an OSSD input to achieve up to PLe and Cat.4 for ISO13849-1
- IP67 protection rating



IDEM Non-Contact Safety Switches

Non-contact safety switches are interlocking devices that are designed to protect both people and machines. They are preferred in certain applications where no physical contact (under normal conditions) takes place between the switch and actuator.

Prices start at \$87.00

- Available in industry standard style plastic and stainless steel housings
- Styles: Magnetic, coded magnetic, and RFID models available
- Stand-alone coded magnetic units available that protect without needing a safety relay
- Wide (>10mm) sensing distance
- High tolerance to misalignment after sensing
- Enclosure protections: IP67, IP69K
- **All Models:** cULus, RoHS, CE approvals

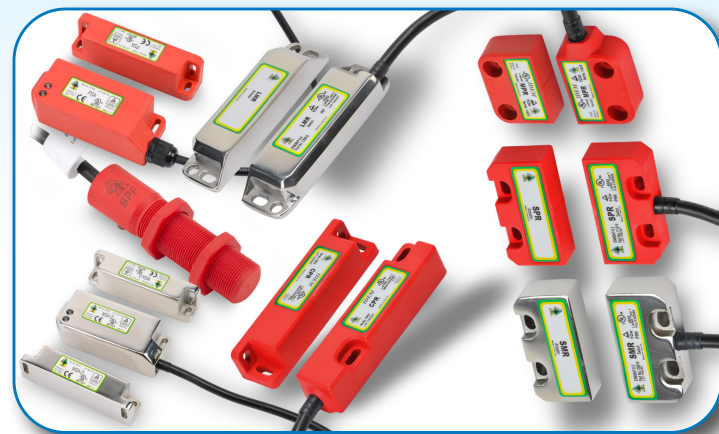

Safety Limit Switches

Safety limit switches provide positively operated switching contacts to verify the position of machine elements or other moving parts for safety related purposes. A variety of actuation mechanisms are available, such as plungers, rollers and levers, all with precise operating points.

Prices start at \$15.50

Models with conduit fittings:

- **HLM Series** - Die Cast Aluminum
- **HLM-SS Series** - Stainless Steel (IP69K)
- **LSPS Series** - Plastic Body (IP67)
- **AP2 Series** - Plastic Body w/pull button reset (IP65)

Sealed models with 2m pigtailed:

- **LSMM Series** - Die-Cast Aluminum (IP67)
- **LSPM Series** - Plastic Body (IP67)



Interlock Switches

These safety switches are developed and manufactured according to IEC and EN European standards for Type 4 machine safety/ OSHA machine guarding.

Prices start at \$31.50

IDEM Interlock Safety Switches

- **IDIS Series** - 22 mm safety interlock switches, tongue key or lever hinge operated, plastic only
- **KM/KM-SS Series** - 30 mm safety interlock switches, tongue key operated, die-cast aluminum and 316 stainless steel options
- **KP/K-SS and K-15 Series** - 40 mm safety interlock switches, tongue key operated, plastic and 316 stainless steel options
- **KLP/KLM/KL3-SS Series** - 30 mm safety solenoid interlock switches, solenoid locking, tongue key interlock operated, power to unlock, plastic, die-cast aluminum, and stainless steel 316 stainless steel options. RFID models available
- **KL1-P/KL1-SS Series** - 40mm safety solenoid interlock switches, solenoid locking, tongue key interlock operated, power to unlock, plastic, and 316 stainless steel options
- **KLTM/KLT-SS Series** - 73mm safety solenoid interlock switches, solenoid locking, tongue key interlock operated, power to unlock, die-cast aluminum and 316 stainless steel options
- **GLM, GLS and GLH Series Pull Cord Housings** - 57mm, 63mm, 65mm and 100mm mounting profiles, 50m, 80m, 100m, 125m and 250m max pull length systems, die-cast aluminum and 316 stainless steel options
- **Interlock Safety Actuator Keys** - nine models available, all keys are 316 stainless steel

IDEM Interlock Safety Switches for Hazardous Areas

Select IDEM interlock switches available in an explosion proof design

Prices start at \$595.00

- **HLM and HLM-SS limit switches**
- **K-SS, KM, KM-SS and KP tongue interlock switches**
- **GLH, GLS and GLS-SS cable pull switches**



Comepi Interlock Safety Switches

Prices start at \$17.00

- **SP2 Series** - 30mm safety interlock switches with tongue keys, shaft hinge, or lever hinge
- **SDM Series** - 50mm safety interlock switches with tongue keys, shaft hinge, lever hinge or cable-pull
- **SBM Series** - 40mm safety interlock switches with tongue keys or cable-pull
- **SCM Series** - 60mm safety interlock switches with tongue keys or cable-pull
- **FEP5K Series** - 40mm solenoid locking safety interlock switches with tongue keys
- **AFPEMK Series** - 40mm RFID coded solenoid locking safety interlock switches with tongue keys
- **All models:** IEC 947-5-1, EN 60947-5-1, UL 508, CSA C22.2 No. 14 approvals



Protect the perimeter of your dangerous machinery with safety mats

Safety Mats

SENTIR safety contact mats are laminar sections which are used to safeguard dangerous areas in industrial and production automation settings. Stepping on the mat triggers an immediate "stop" signal in order to prevent endangering movements. Prices start at \$177.00

Types:

- Tapered Edge
- Straight Edge

Features:

- Anti-slip surface
- Standard sizes available
- Resistant against most contaminants and moisture up to IP65
- Available in standard black or safety yellow

Tapered Edge

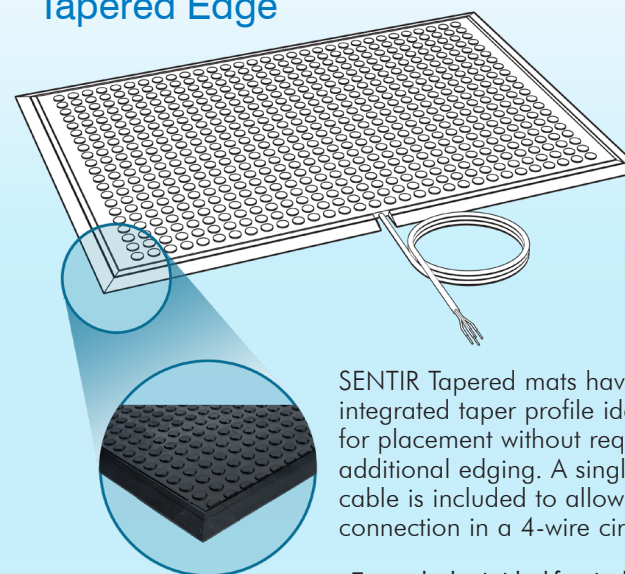

SENTIR Tapered mats have an integrated taper profile ideal for placement without requiring additional edging. A single 6m cable is included to allow direct connection in a 4-wire circuit.

- Tapered edge is ideal for single mat installations
- 6 standard sizes up to 3' x 5'

Straight Edge

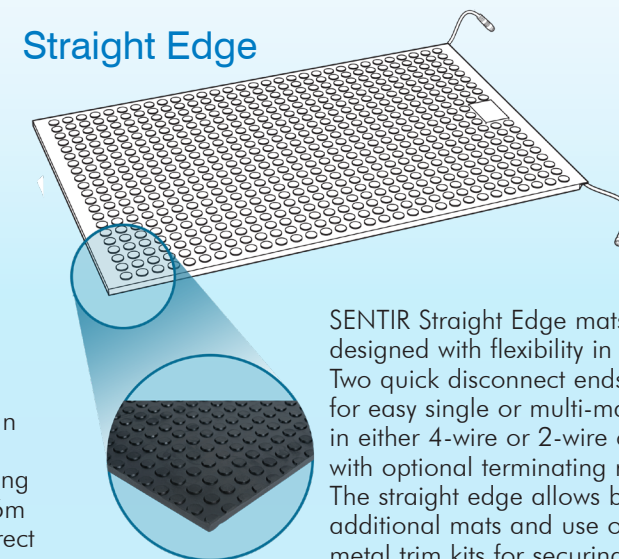

SENTIR Straight Edge mats are designed with flexibility in mind. Two quick disconnect ends allow for easy single or multi-mat wiring in either 4-wire or 2-wire circuits with optional terminating resistor. The straight edge allows butting of additional mats and use of optional metal trim kits for securing to floor.

- Straight edge is preferred for multi-mat configurations
- Use optional trim kits to taper edges as needed
- Quick-disconnects speed assembly
- 6 standard sizes up to 3' x 5'

Diamond Plate

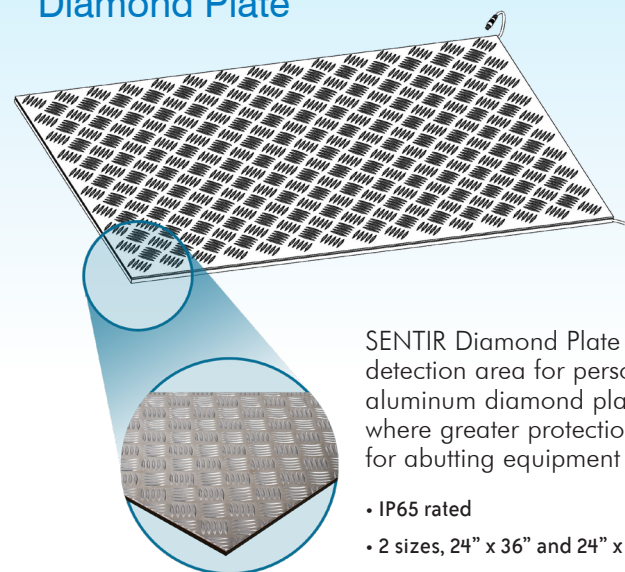

SENTIR Diamond Plate Safety mats provide a wide horizontal detection area for personnel. Polyurethane safety mats with an aluminum diamond plate surface are ideal for applications where greater protection is desired. Straight edge models allow for abutting equipment or creating large arrays of mats.

- IP65 rated
- 2 sizes, 24" x 36" and 24" x 48"



IDEM Skorpion Rotary Trapped Key Switches

IDEM Rotary trapped key systems control access to running equipment with locks and rotary keys. To disable the machinery and unlock a gate, the key is turned and removed from the control switch; this disables power to the machinery. The released key is inserted into the gate access module to unlock the gate.

Prices start at \$223.00

- Sets are available for up to three gates (or doors)
- Partial or full body access version
- Control switches with or without solenoid locking are available separately
- Switch enclosures available



Dold Safemaster Trapped Key Gate Sets

Dold Trapped Key System Gate Sets provide you with a full trapped key safety system, in **one- to five-gate sets**. They are available in either standard (SX) or solenoid-locking (ZRH) versions.

All keys and their corresponding 01 and 10 modules are identical within a set, but unique to any other set. We also offer tongue key actuators (purchased separately from the gate sets), and optional items such as door actuators, captive safety key sets, key modules for key exchange box setup, and mounting plates.

Prices start at \$381.00



Simple, Intelligent, Modular Safety Devices

The Z-Range Safety Switch System offers a great option for simplicity and modularity in machine safety interlocking, reducing wiring cost and time. Up to 30 Z-Range devices with OSSD outputs can be connected in series to one safety relay while maintaining PLe performance rating. These devices are an excellent choice for modular machines when utilizing premade T-port cables and junction blocks. All devices are rated for PLe and SIL3 and offer built-in local diagnostics. Available devices include:

- Non-contact safety switches
- Solenoid locking RFID tongue interlock safety switches
- Tongue interlock safety switches
- Hinge interlock safety switches
- Cable-pull safety switches
- Emergency stop control stations
- Z-Range Safety Switch System accessories

Non-Contact RFID-coded Safety Switches

Z-Range non-contact RFID-coded safety switches can monitor the opening and closing of machine guards, doors, or other machinery without a physical connection. These switches have OSSD outputs.

Prices start at \$160.00

- RFID provides a high degree of anti-tamper - virtually impossible to override
- Unique RFID or series coding RFID available
- Available in polyester or stainless steel bodies
- IP69K protection rating

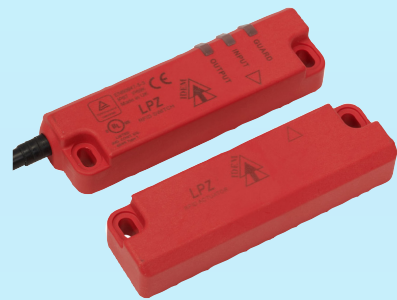

Solenoid Locking RFID Tongue Interlock Safety Switches

Z-Range RFID coded tongue interlock safety switches incorporate high anti-tamper RFID coding and provide PLe safety levels to ISO13849-1. Solenoid locking adds an extra layer of security. These devices have OSSD outputs.

Prices start at \$347.00

- Available in Plastic, die-cast metal, or stainless steel bodies
- Front and End actuator entry points
- Rotating head – 8 possible entry positions
- Stainless steel models are IP69K, all others are IP67



Tongue Interlock Safety Switches

Z-Range tongue interlock safety switches fit sliding, hinged or lift-off machine guards and doors, and provide a tamper-resistant actuator mechanism to determine if a machine guard is in place. These devices have OSSD outputs.

Prices start at \$234.00

- Available in die-cast metal or stainless steel bodies
- Rotating head with 8 possible entry positions
- Stainless steel models are IP69K, die-cast metal models are IP67



Hinge Interlock Safety Switches

Z-Range hinge interlock safety switches are designed to be fitted to the hinged axis of machine doors, providing a robust hinge function in addition to interlock position sensing. Blank hinges are also available if 2 hinges per door are required. These devices have OSSD outputs.

Prices start at \$307.00

- Available in die-cast metal or stainless steel bodies
- Mechanical switches operate by rotation of a cam and actuator to cause deflection of the plunger
- Easy-to-understand LED indication and diagnostic functions
- IP69K protection rating



Cable-Pull Safety Switches

Z-Range cable-pull safety rope switches are designed to protect long conveyor lengths where guards are not feasible. This type of switch is traditionally a positively operated electromechanical contact but these devices use an electronic contact block that outputs an OSSD signal.

Prices start at \$350.00

- Available in die-cast metal or stainless steel bodies
- Dual color diagnostic LED
- Available in protection lengths of 50m, 80m, 100m, 125m, and 250m
- Lefthand, righthand, ambidextrous and dual-head styles
- Stainless steel models are IP69K; die-cast metal models are IP67



Emergency Stop Control Stations

Z-Range emergency stop control stations are rugged emergency stops with OSSD outputs. The enclosed station features a 40mm twist-to-release mushroom head operator with or without a button shroud.

Prices start at \$143.00

- Available in plastic or stainless steel enclosures
- Twist-to-release operator button
- Dual color diagnostic LED
- Stainless steel models are IP69K, plastic models are IP67



Z-Range Safety Switch Installation Example

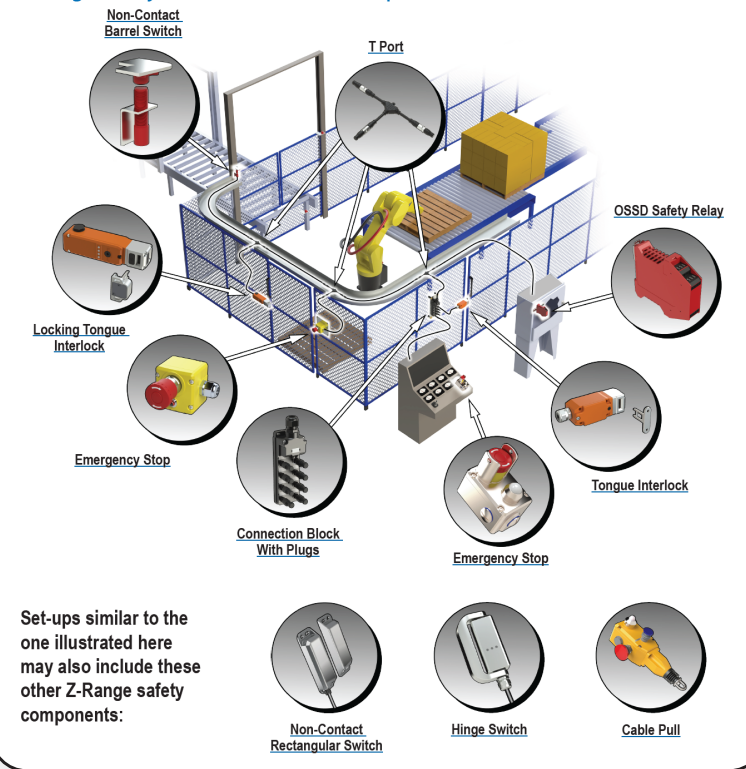

Z-Range Safety Switch System Accessories

Accessories for the Z-Range safety switches include everything you need for easy modular electrical connections, including an 8-port Z-range junction block, connection cables, T-port cable and shoring plugs.

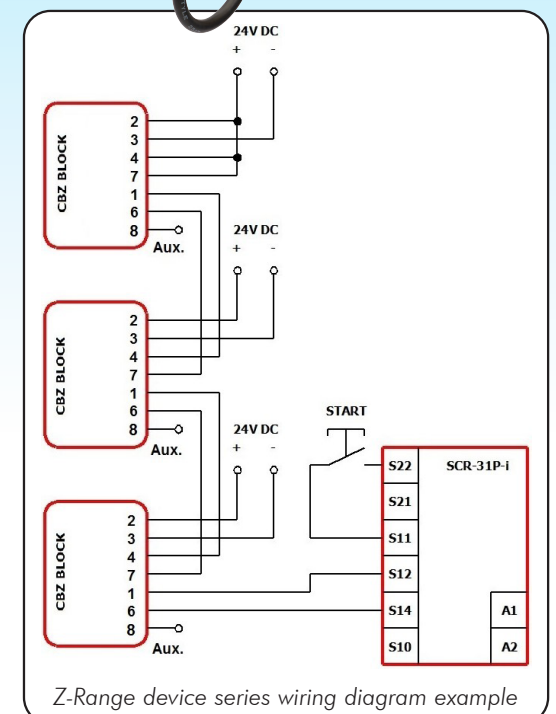

Z-Range device series wiring diagram example



Safety Edges

SENTIR safety contact edges are pressure-sensitive sensors used to ensure the safety of closing edges at possible crushing or shearing points which are prone to accidents. They may be installed near automatic gates, machines and other facilities for handling equipment to detect conditions that could cause bodily harm or damage machinery.

Prices start at \$26.50

Types:

- 15mm x 10mm
- 15mm x 25mm
- 25mm x 30mm
- 25mm x 45mm
- 30mm x 70mm

Features:

- Optimized material properties guarantee fast switching results
- Several lengths available that can be easily cut to fit any application
- Can wire in 2- or 4-wire circuits
- Aluminum mounting rail is easy to install
- Daisy chain up to 5 sections or 100m with standard M8 quick-disconnect cables

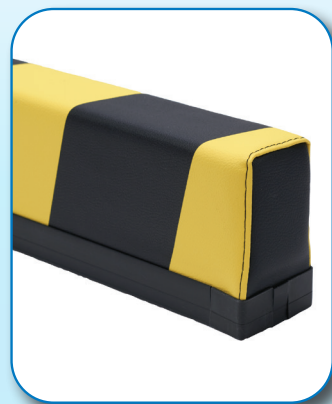

Safety Bumpers

Safety bumpers are typically used to detect presence of heavy equipment in applications involving transport vehicles, industrial trucks, high-shelf warehouses, production lines, or mobile systems. These vibration-resistant bumpers provide reliable detection in harsh conditions. When used in conjunction with a safety relay, they provide fail-safe triggering of an intended safety function. Available in 60mm x 100mm and 100mm x 200mm profiles.

Prices start at \$222.00

Lengths:

- 300mm
- 460mm
- 610mm
- 760mm
- 910mm
- 1220mm
- 1520mm
- 1830mm

Features:

- Individual mounting options
- Insensitive to vibration
- Reliable switching operation in rugged applications
- Can wire in 2-wire or 4-wire circuits

Controllers for Safety Mats and Edges

Safety relays are used to evaluate safety contact mats, safety contact edges and safety bumpers sensors at crush and shear locations. Single-channel, two-channel, and multi-function models available.

Prices start at \$26.50



Warning: Machine safety products sold by AutomationDirect are Safety components only.

The purchaser/installer is solely responsible for the application of these components and ensuring all necessary steps have been taken to assure each application and use meets all performance and applicable safety requirements and/or local, national and/or international safety codes as required by the application. AutomationDirect cannot certify that our products used solely or in conjunction with other AutomationDirect or other vendors products will assure safety for any application.

Any person using or applying any safety products sold by AutomationDirect is responsible for learning the safety requirements for their individual application and applying them, and therefore assumes all risks, and accepts full and complete responsibility for the selection and suitability of the product for their respective application.

AutomationDirect does not provide design or consulting services, and cannot advise whether any specific application or use of our products would ensure compliance with the safety requirements for any application.

Protect your circuits in hazardous locations with STAHL safety isolators and barriers

Safety Isolators and Zener Barriers

STAHL isolators and zener barriers provide a compact, easy-to-connect and user-friendly way to provide intrinsic safety and galvanic separation between the control system and field device in a hazardous location.

Prices starting at \$202.00

- Dual-channel modules available for all circuit types
- Digital, analog, frequency and temperature modules available
- Digital and analog modules are rated for SIL applications
- Intrinsically safe zener barrier for thermocouple signals available
- Optional configuration kit available for temperature and frequency modules
- Optional pac-BUS saves wiring time and money
- Analog modules are HART compatible



Save time and wiring with the optional pac-BUS system

STAHL pac-BUS is an optional system to reduce wiring and installation time while providing a cleaner, more modular assembly.

- Quick, easy wiring
- Can be installed on standard DIN rail without tools by simply snapping into place
- Can be expanded at any time with additional pac-BUS units
- Suitable for industrial environments subject to vibration

