

# AUTOMATIONDIRECT.com

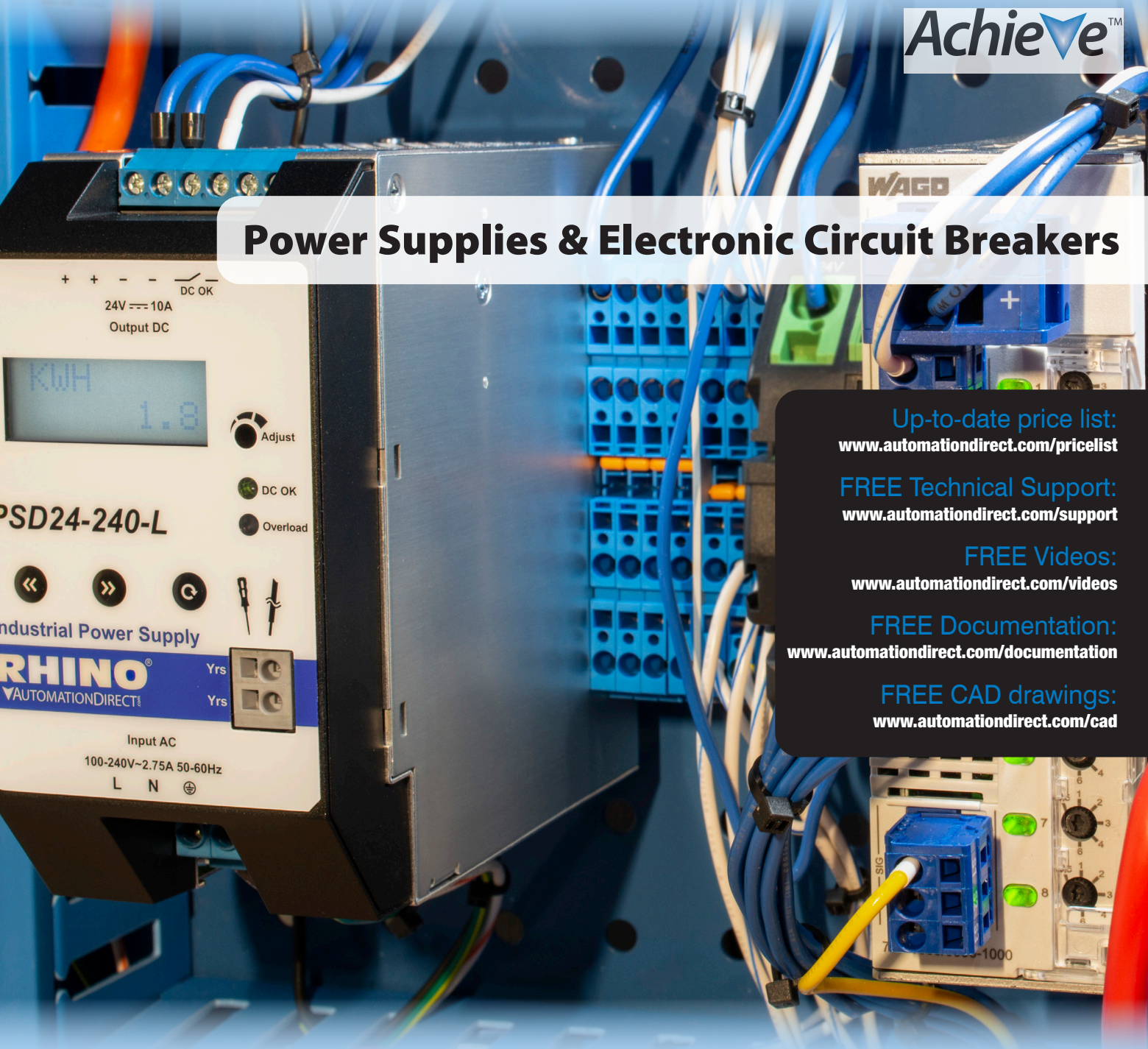

## Power Supplies & Electronic Circuit Breakers



Up-to-date price list:  
[www.automationdirect.com/pricelist](http://www.automationdirect.com/pricelist)

FREE Technical Support:  
[www.automationdirect.com/support](http://www.automationdirect.com/support)

FREE Videos:  
[www.automationdirect.com/videos](http://www.automationdirect.com/videos)

FREE Documentation:  
[www.automationdirect.com/documentation](http://www.automationdirect.com/documentation)

FREE CAD drawings:  
[www.automationdirect.com/cad](http://www.automationdirect.com/cad)



# DC Power Supplies

## What is a power supply?

Industrial power supplies convert AC power to DC power for manufacturing and process equipment such as PLCs, HMIs, relays, sensors, actuators, and drives. Most common are linear power supplies and switching power supplies.



The main difference between switching and linear power supplies is how they convert AC to DC output voltage. Switching power supplies first rectify the AC line supply and then transform it, while linear power supplies first transform the AC supply, then rectify it. Switching power supplies, intended for general use in automation, have better efficiency, less heat loss, wider input voltage ranges, and smaller size and weight. Linear power supplies have fewer harmonics and have more precise output regulation.

Considerations when selecting a power supply:

- Input voltage
- Output voltage
- Output current
- Mounting
- Environmental ratings

## Input Voltage

The typical input voltage range for a power supply is 120-240VAC single-phase. However, power supplies are available that accept 3-phase inputs; some even take DC inputs.

## Output Voltage

Power supplies have standard DC output voltages such as 5, 12, 24, and 48 VDC. They usually come with an adjustment potentiometer to trim the output by approximately +/- 10%, and a built-in DC OK LED indicator and contact to provide alerts for overload conditions.

## Output Current

When DC power is required, it is crucial to calculate the worst-case current draw of all devices powered from the DC supply. Some loads require a higher starting current, which can be several times their nominal operating full-load current. For example, a capacitive load appears as a short circuit with a high current draw until the capacitor reaches full charge. When selecting a power supply, it is critical to account for this additional inrush current. Some power supplies provide short-term reserve power to handle this extra load, eliminating the need for oversized power supplies and their associated costs.

Applications with high output requirements call for power supplies that can handle power peaks. High-efficiency power supplies reduce losses, save cabinet space, and increase energy savings. Intelligent load management reliably powers equipment and protects it at the same time. Parameterizable overload behavior provides configurable current and switching modes allowing you to tailor your power supply to meet your system requirements.

## Mounting

Power supplies are typically DIN-rail mounted; however, open frame and panel mount power supplies offer more flexibility because they can easily be screw-mounted in three different orientations. Machine mount supplies mount directly to the equipment without requiring an enclosure, even when used outdoors.

## Environmental Ratings

Some power supplies are Class 1, Div 2 rated, making them suitable for use in hazardous locations. Others offer rugged machine mount options with IP67 and NEMA 4X ratings for harsh outdoor environments. Encapsulated power supplies come in ultra-compact, low-profile housings and are ideal for space-limited applications. Open frame power supplies are very cost-effective; however, they have little or no protection from the elements. They must be mounted in a suitable enclosure or have a conformal coating to protect them from dust, humidity, and contamination.

## Overload, Overvoltage, and Thermal Protection

Many power supplies have built-in protection for transient surges, overloads, short circuits, and overvoltage protection. NEC Class 2 power supplies limit voltage and current output, making them less of a shock and fire hazard. Using NEC Class 2 circuits means reduced and less expensive wiring methods and over-current protection requirements. Also, the testing and approval process is much easier.

## DC Ripple

Ripple is the amplitude of the AC component that rides on a DC voltage output. A typical rating for most applications is 100mV peak-to-peak. It is necessary to determine the amount of ripple that powered devices can tolerate and then select a power supply that meets the most stringent requirement.

## Output De-rating for Power Supplies

Manufacturers offer a way to extend a power supply's input voltage and temperature rating when it is run at a decreased capacity. As a result, they often publish derating curves in their specifications to illustrate the relationship between temperature or input voltage and output capacity.

## Output Load De-rating vs. Surrounding Air Temperature

Power supplies have a maximum temperature threshold for 100% output capacity. It is common for manufacturers to allow a derating for temperatures above this threshold. Power supplies are affected by temperature and will fail if used above their maximum temperature rating. As a result, manufacturers provide a derating curve to show the relationship between temperature and safe output level.

The following illustration shows the derating curve for a RHINO PRO PSD24-120-L power supply. The power supply must be derated from 100% output at 50 C [122 F] to 50% at 70 C [158 F] horizontally mounted. However, if vertically mounted, it is derated from 100% at 60 C [140 F] to 75% at 70 C [158 F].

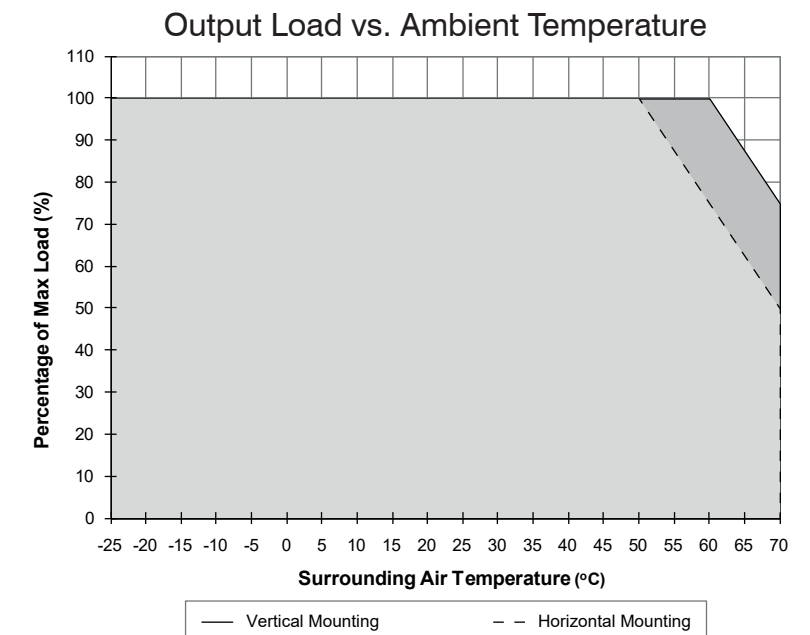

RHINO PRO PSD24-120-L Temperature Derating Curve

## Output Load De-rating vs. Input Voltage

A derating curve shows the relationship between the input voltage and the maximum allowable output level. Manufacturers often require derating when the input voltage falls below the minimum threshold specified. The following curve shows the derating curve for a RHINO TOUGH PSX-24-120 power when the input voltage drops below 120 VAC.

Following these derating practices will increase the life and reliability of a power supply and prevent premature failure.

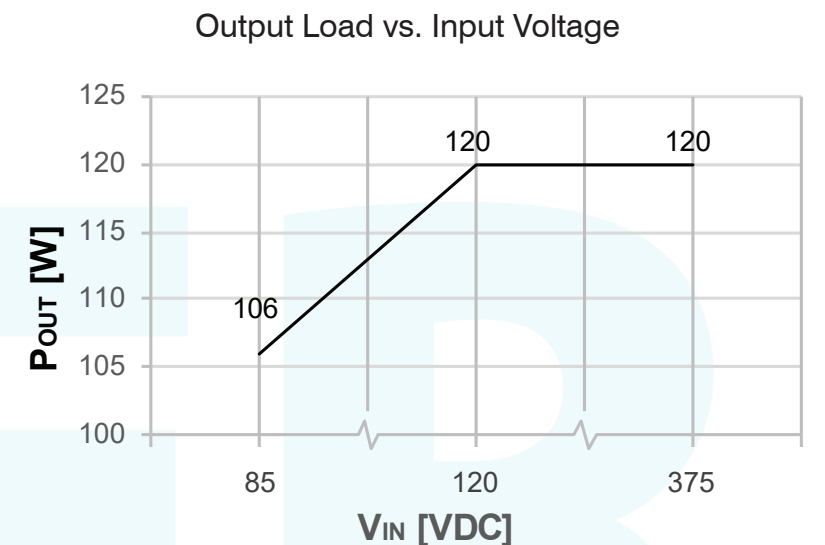

RHINO TOUGH PSX-24-120 Input De-rating Curve

# Power Supply Comparison Chart

Switching Power Supply Feature Comparison								
Power Supply Series	Functionality	Price (\$-\$\$\$\$)	Case	Mount	UL	HazLoc Rated	NEC Class 2	Output Power (W)
RHINO PSS-S	BASIC	\$	Metal	Panel	✓	✗	✗	35 - 100
Achieve PSA	BASIC	\$	Metal/Plastic	DIN Rail	✓	✗	✗	75 - 480
RHINO PSL	BASIC	\$\$	Low-Profile, Plastic	DIN Rail	✓	✗	✓	7.5 - 91.2
RHINO PSV	BASIC	\$	Metal/Plastic	DIN Rail	✓	✗	✓	15 - 480
RHINO PSE	BASIC	\$\$\$	Compact, Plastic, Encapsulated	DIN Rail/Panel	✓	✗	✗	15 - 60
RHINO PSR	BASIC	\$\$	Metal	DIN Rail	✓	✗	✗	120 - 960
FA	BASIC	\$\$	Open Frame	DIN Rail	✓	✓	✗	30 - 89
WAGO Eco2	BASIC	\$\$	Metal/Plastic	DIN Rail	✓	✗	✗	30-240
RHINO PSS*-U	STANDARD	\$	Metal	Panel	✓	✗	✗	151
RHINO PSC	STANDARD	\$\$\$	Low-Profile, Plastic	DIN Rail	✓	✗	✓	12 - 90
RHINO PSB-S	STANDARD	\$	Metal/Plastic	DIN Rail	✓	✓	✗	60 - 960
RHINO PSP	STANDARD	\$\$\$	Compact, Plastic	DIN Rail/Panel	✓	✗	✗	20 - 240
RHINO PSM	STANDARD	\$\$\$\$	Metal	DIN Rail	✓	✗	✗	78 - 600
RHINO PSFA	STANDARD	\$	Metal	Panel	✓	✗	✗	60
LUTZE CPS	PERFORMANCE	\$\$\$	Metal	DIN Rail	✓	✗	✗	120 - 960
RHINO PSN	PERFORMANCE	\$\$\$	Metal	DIN Rail	✓	✗	✗	80 - 960
RHINO PSRP	PERFORMANCE	\$\$\$\$	Metal	DIN Rail	✓	✗	✗	120 - 960
RHINO PSD	PERFORMANCE	\$\$\$\$	Metal/Plastic	DIN Rail	✓	✗	✗	120 - 480
RHINO PSH	PERFORMANCE	\$\$\$	Metal	DIN Rail	✓	✓	✗	80 - 480
WAGO Pro2	PERFORMANCE	\$\$\$	Metal	DIN Rail	✓	✗	✗	120 - 960
RHINO PSX	TOUGH	\$\$\$\$	Metal-Outdoor	Chassis	✓	✓	✗	96 - 120
RHINO PSRT	TOUGH	\$\$\$	Metal-Outdoor	Chassis	✓	✗	✓ (100W)	91.2 - 192

# Switching power supplies at great prices!

## DIN Rail Mount Power Supplies

### Achieve™ PSA Series Power Supplies

Achieve PSA series value power supplies offer prices well below the competition and are ideal for price-sensitive users who require basic yet reliable power output for general industrial applications. Their overcurrent protection is designed to operate in constant current mode, making the PSA series suitable for inductive and capacitive load applications.

- Universal 85-264 VAC/120-375 VDC input voltage
- Up to 90% efficiency
- 12, 24, or 48 VDC adjustable output options
- Plastic or aluminum housings (depending on model)
- 75, 120, 240, and 480 Watt models



Starting at **\$25.50**  
(PSA-24-75)



Starting at **\$29.00**  
(PSL-12-010)

### RHINO PSL Series Low-Profile Power Supplies

RHINO PSL series power supplies are plastic low-profile switching supplies that are UL508 listed and UL60950-1 recognized for NEC Class 2\* compliance in industrial, commercial, and residential applications.

- Universal 90 - 264 VAC/125-375 VDC input voltage
- Output current limit
- 5, 12, or 24 VDC adjustable outputs
- Plastic-housed low-profile form factor
- 7.5 to 91.2 Watts
- \* PSL-12-090 is not NEC Class 2

### RHINO PSV Series Value Power Supplies

The RHINO PSV value series offers economical power supplies in a wide selection of voltage and wattage ranges. The 15-100 W models feature ultra-compact plastic housings and are NEC Class 2 compliant.

- Universal 85-264 VAC input voltage
- Up to 89.0% efficiency
- 5, 12, 24, or 48 VDC outputs
- Metal or plastic housings
- Ultra-compact sizes



Starting at **\$37.00**  
(PSV5-155)



## DIN Rail Mount Power Supplies (cont.)

### RHINO PSR Series Power Supplies

RHINO PSR series DIN rail mount high-efficiency industrial power supplies feature an ultra-slim design in a rugged aluminum housing. These economical power supplies offer overcurrent protection in constant current mode, making them suitable for charging applications.

- 120/240 VAC single-phase or 480 VAC three-phase input options
- Up to 40A (960W) output current
- 24-28 VDC adjustable outputs
- Up to 94.5% efficiency
- Built-in DC OK relay and LED indicator
- IP20 finger-safe protection rating



Starting at  
**\$69.50**  
(PSR-24-120)

## DIN Rail Mount Power Supplies (cont.)

### RHINO SELECT PSB-S Series Power Supplies

RHINO SELECT PSB-S series power supplies offer high performance and reliability at a low cost. They feature rugged aluminum housings, conformal coated circuit boards, and select models offer approval for Class 1, Division 2 hazardous locations.

- Universal input, 85-264 VAC / 120-375 VDC single-phase or 320-600 VAC three-phase input
- 12, 24, or 48 VDC outputs, 15 to 960 Watts
- Overload, overvoltage and thermal protection
- 24 VDC output, single phase input models
- for Class 1, Div 2 hazardous locations
- 24 VDC (adjustable), 40A (960W) output, 320-600 VAC 3-phase model



Starting at  
**\$49.50**  
(PSB24-060S)



Starting at  
**\$60.00**

### WAGO Eco2 Series Power Supplies

WAGO Eco2 series power supplies offer performance and value, featuring high efficiency and a compact, space-saving design, making them ideal for space-limited applications. These economical power supplies provide reliable performance and long service life for a variety of applications, such as industrial automation, building management systems, machine control, and robotics.

- Universal 90-264 VAC input voltage
- 24 VDC adjustable output
- 30, 120, and 240 Watts
- Up to 90% efficiency
- Metal or plastic housings
- Built-in DC OK relay and LED indicator

### RHINO SELECT PSP Series Slimline Power Supplies

RHINO SELECT PSP series slimline power supplies are plastic housed ultra-compact switching power supplies that offer an excellent price/performance ratio. They feature universal inputs, adjustable DC voltage outputs, and low output ripple.

- Universal input 120/240 VAC or 85-264 VDC
- 20 to 240 Watts
- 5 VDC, 20 W, 4 A output
- 12 VDC from 24 to 120 Watts
- 24 VDC from 24 to 240 Watts
- Compact footprint
- Plastic housing
- Overload and overvoltage protection



Starting at  
**\$76.00**  
(PSP05-020S)

### RHINO SELECT PSC Series Low-Profile Power Supplies

RHINO PSC series power supplies are plastic low-profile housed switching supplies available in 5, 12, and 24 VDC adjustable output models. They are UL508 listed and UL1310 recognized for NEC Class 2 compliance in industrial, commercial, and residential applications.

- Universal 85 to 264 VAC input voltage and output current limitation
- 5, 12, or 24 VDC adjustable outputs
- 12 to 90 Watts
- Plastic-housed, low-profile



Starting at  
**\$56.00**  
(PSC-05-012)



Starting at  
**\$123.00**  
(PSM24-090S)

### RHINO SELECT PSM Series Industrial Grade Power Supplies

RHINO SELECT PSM series power supplies are industrial grade switching DC output supplies with a sturdy steel case to withstand harsh environments. Autoselect inputs for 115 VAC or 230 VAC and international agency approvals make the RHINO PSM series suitable for worldwide use.

- Universal 100/230 VAC input voltage
- Industrial grade
- Sturdy metal case
- 12 VDC from 78 to 156 Watts
- 24 VDC from 90 to 600 Watts
- Low output ripple
- Specialty modules for redundancy, power backup and UPS
- Overload and overvoltage protection



# DIN Rail Mount Power Supplies (cont.)

## LUTZE Compact Switching Power Supplies

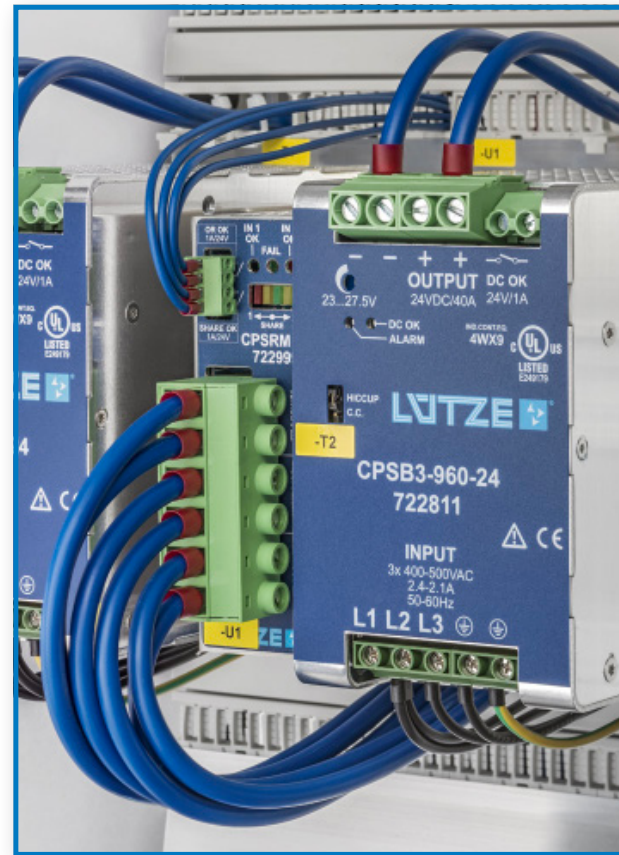

LUTZE, a well-known name in the automation industry for over 60 years, manufactures a wide range of dependable products including quality, economical, and reliable compact power supplies. LUTZE Compact series power supplies are ideal for industrial

applications where high inrush power is essential and where space-saving designs and long-lasting operation are desired. These power supplies are smaller than the industry standard, yet still operate with supreme efficiency using advanced digital technology.

### WITH POWER BOOST



Starting at \$165.00

### CPS 3-Phase Series Switching Power Supplies

LUTZE compact 3-phase series 24 VDC power supplies have an efficiency rating of over 91%, which means low power loss and low heat dissipation. The integrated power boost function allows higher peak loads to be energized for a short period of time. In addition, this unit has the convenience of allowing remote ON/OFF control to significantly reduce energy consumption.

- Compact footprint fits any tight space application
- Status indicator and output relay allows remote monitoring
- Aluminum housing
- 35mm DIN rail mount
- IP20 rated
- Available in 120, 240, or 960W models
- 5 year warranty

mPWR-8 Power Supplies

## LUTZE Power Supplies (cont.)

### CPS ECO Series Switching Power Supplies

LUTZE ECO series 24 VDC single-phase power supplies were developed with the newest technical innovations in mind. This compact, economical series of power supplies provides up to 91% power conversion efficiency. The output voltage adjustment provides easy tuning of desired voltage.

- Compact footprint fits any tight space application
- Status indicators and output relay allows remote monitoring
- Aluminum housing
- 35mm DIN rail mount
- IP20 rated
- Available in 120, 240, or 480W models
- 5 year warranty

### ECONOMY LINE



Starting at \$97.00

### ULTRA COMPACT



Starting at \$155.00

### CPS Ultra Series Switching Power Supplies

LUTZE Ultra series 24 VDC single-phase power supplies are compact units that are 50% smaller than standard industrial power supplies, which results in considerable space and money savings. This series provides up to 93% power conversion efficiency.

- Compact footprint even smaller than ECO series
- Status indicators and output relay allows remote monitoring
- Power boost - 150% for 5s
- Aluminum housing
- 35mm DIN rail mount
- IP20 rated
- Available in 120, 240, or 480W models
- 5 year warranty

### MAX FLEXIBILITY



Starting at \$230.00

### CPS Universal Series Switching Power Supplies

LUTZE Universal series 24 VDC power supplies provide high efficiency, compact size, and power boost while allowing maximum installation flexibility. These units offer 1-, 2-, or 3-phase inputs, making them a versatile power supply that can be used for many applications.

- Compact footprint fits tight applications
- Status indicators and output relay allows remote monitoring
- Aluminum housing
- 35mm DIN rail mount
- IP20 rated
- Available in 240 or 480W models
- 5 year warranty

www.automationdirect.com/dc-power-supplies

Power Supplies mPWR-9



# High Performance Power Supplies

## RHINO PRO High Performance PSN Series Power Supplies

RHINO PRO PSN series high performance 24 VDC switching power supplies are available with single-phase and three-phase inputs, universal AC input voltage range, and a built-in constant current circuit for charging applications.

- Universal AC input voltage range (single-phase units)
- Built-in constant current circuit for charging applications (three-phase units)
- Active Power Factor Correction (PFC) - Active input current wave shaping, high frequency filtering, and source current feedback sensing for waveform control
- Power Boost of 150% up to 7 seconds
- Advanced Power Boost (APB) – ensures continuous operation when a large inrush current is detected due to faulty load on a multiple load connection
- DC OK contact and LED indicator for DC OK/Overload



Starting at **\$97.00**  
(PSN24-080)



## RHINO PRO High Performance PSD Series with LCD

RHINO PRO PSD series versatile 24 VDC switching power supplies feature an LCD which displays output current, output voltage, peak hold current, lifetime expectancy, and ambient temperature data.

- Universal AC input voltage range
- Lifetime expectancy alarm signal and monitoring
- Built-in active Power Factor Correction with up to 94% efficiency
- Power Boost of 150% up to 7 seconds
- LCD display of output current / voltage / peak current and temperature
- Advanced Power Boost (APB) – protects system to ensure continuous operation when large inrush current detected due to faulty load on a multiple load connection
- DC OK contact and LED indicator for DC OK Overload

Starting at **\$204.00**  
(PSD24-120-L)

## RHINO PRO High Efficiency PSH Series Power Supplies

RHINO PSH series power supplies offer best-in-class efficiencies up to 94.5%, temperature performance range of -25°C to 70°C, and agency approvals for extreme conditions. They are UL 508 and hazardous location listed, UL 60950 recognized, ATEX certified, CE marked, and RoHS compliant.

- Universal 85 to 264 VAC input voltage
- Up to 94.5% efficiency
- 12, 24, or 48 VDC outputs
- Short circuit and overload protection
- 80 to 480 Watts



Starting at **\$104.00**  
(PSH-48-080)



## RHINO PRO Compact PSRP Series

RHINO PRO PSRP series power supplies offer a sleek, space-saving design with push-in connectors and a rugged aluminum housing.

- Up to 94.8% efficiency
- 12 or 24 VDC outputs
- 120 to 960 Watts
- Short circuit and overload protection

Starting at **\$156.00**  
(PSRP-24-120)

# WAGO Pro2 Series Power Supplies and Modules

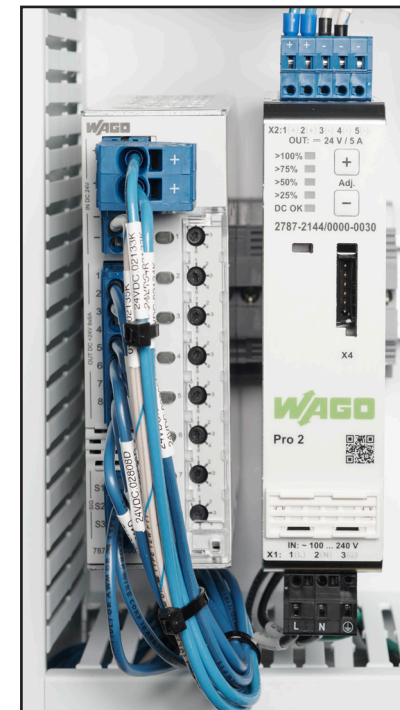

WAGO Pro2 series high-efficiency power supplies reduce losses, save cabinet space, and increase energy savings. With TopBoost, PowerBoost, and configurable overload behavior, the WAGO Pro2 power supply protects equipment and provides intelligent current and switching modes.

- TopBoost provides a 600% current pulse for 15 milliseconds which safely trips downstream circuit breakers, dropping out problem circuits with high overload or short-circuit conditions
- PowerBoost allows 150% output current for five seconds to reliably power high in-rush loads
- 12, 24, or 48 VDC outputs
- 120 to 960 Watts
- Configurable overload behavior
- Configurable digital signal input and output, optical status indication, function keys
- Free configuration and monitoring software
- Suitable for both parallel and series operation
- Single and three-phase models



Starting at **\$179.00**

## WAGO Pro2 Communication Modules

WAGO Pro2 communication modules easily snap into place as an add-on to the Pro2 power supplies. These modules support various communication protocols with their respective communication ports, allowing connectivity to PLCs for programming and monitoring. Communication modules also provide accessibility to select features and real-time data gathered by the power supplies.

Quick and easy connectivity with Productivity, CLICK, and Do-More PLCs



**Pro2 Communication Module**  
Communication Ports (Remove Cover)  
**Protocols Available**

- Modbus RTU - with (2) RS-485 (RJ45) ports
- EtherNet/IP - with (2) Ethernet 10/100 Base-T (RJ45) ports
- Modbus TCP/IP and UDP/IP - with (2) Ethernet 10/100 Base-T (RJ45) ports
- IO-Link - with (1) 3-position removable terminal port

Starting at **\$69.00**

Examples of data and settings that can be accessed with the Pro2 communication modules:

- Output On
- "Active droop" parallel mode
- Overload limit active
- Enable switching the DC output ON and OFF via cyclic process data
- Constant current
- Constant current (latching mode)
- Hiccup mode
- Electronic circuit breaker
- Latching after thermal overload
- Power Boost
- Top Boost

## Configuration and Monitoring Software

The free configuration software for WAGO Pro2 series power supplies includes long-term monitoring for preventative maintenance and service to help prevent costly downtime.

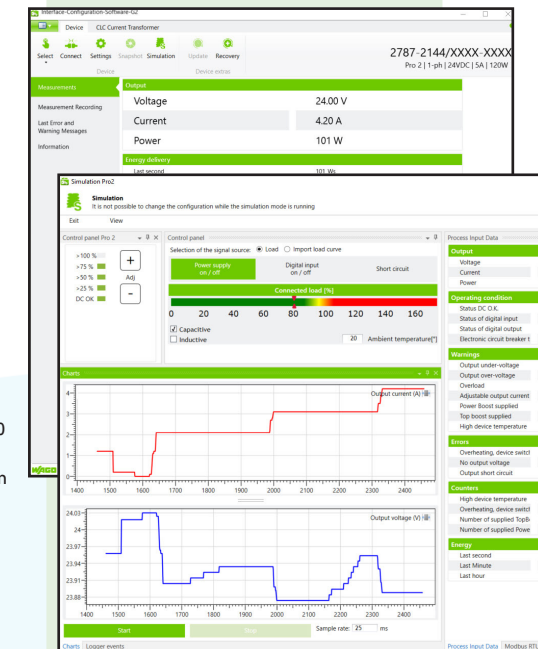

**FREE Configuration and Monitoring Software!**  
[Click here to download](#)



## Rugged Machine Mount Power Supplies



Starting at  
**\$289.00**  
(PSX-24-120)

### RHINO TOUGH PSX Series

Rugged RHINO TOUGH series machine mount power supplies are perfect for applications that require a dependable DC power supply in harsh environments.

- 12 or 24 VDC outputs
- Universal input 85 to 264 VAC
- Hazardous location Class I, Div 2
- IP67 and NEMA 4X protection rating

### RHINO TOUGH PSRT Series

RHINO TOUGH PSRT series machine mount power supplies are designed for industrial applications outside of the control cabinet. These field-mountable power supplies offer a compact footprint and allow machine mounting near the load.

- Up to 94.4% efficiency
- 24 VDC output
- Universal input 90 to 264 VAC
- IP67 protection rating

Starting at  
**\$263.00**  
(PSRT-24-100)



## Encapsulated Chassis Mount Power Supplies

Fully encapsulated power supplies provide maximum environmental protection for reliable DC power. These low-profile, plastic-housed units, with a universal input of 120/240 VAC, are available with single (up to 60W) or dual outputs (up to 30W).

### PSE Series

- A cost-effective solution for commercial and industrial applications in dirty and dusty environments
- Output Power: 15 to 60 W

Starting at  
**\$62.00**  
(PSE12-115)



## Enclosed Chassis Mount Power Supplies

RHINO enclosed chassis-mount power supplies offer high performance for a low cost. All units are overload, overvoltage, and thermally protected, with rugged aluminum cases that mount in various physical orientations. Units with UPS functionality are available.



Starting at  
**\$13.00**  
(PSS-12-035-S)

### PSS-S Series

Reliable power at a low cost  
Output Power: 35 to 100 W

### PSS\*-U Series

Offers battery switchover capability  
Output Power: 151 W

## Linear Power Supplies

Regulated and unregulated open frame linear power supplies offer several advantages, including low output ripple, high output voltage accuracy, and low output noise. They are relatively simple in design and generate minimal electromagnetic interference (EMI) due to the absence of high-frequency switching components.

## Regulated Open Frame Linear Power Supplies

### INTERNATIONAL POWER DC POWER SUPPLIES IH Series Regulated Open Frame Linear Power Supplies



Starting at  
**\$75.00**  
(IHB5-3-OVP)

International Power IH series regulated open frame linear power supplies are designed to operate over a wide range of AC power sources. They maintain a constant output voltage, regardless of changes in input voltage or load variations, and offer better voltage regulation than other types of power supplies, ensuring accurate and consistent power delivery.

- 5, 12 to 15, ± 12, ± 15, or 24 VDC outputs
- 100/120/220/230-240 VAC input ranges
- Overvoltage protection on 5 VDC outputs
- +/- 0.05% regulation
- Made in USA

## Unregulated Open Frame Linear Power Supplies

### INTERNATIONAL POWER DC POWER SUPPLIES IP500U Series Unregulated Open Frame Linear Power Supplies



Starting at  
**\$367.00**  
(IP500U36)

International Power IP500U series unregulated open frame linear power supplies are designed for low-cost, high-current applications when full regulation is not required. These rugged, highly reliable power supplies are ideal for powering solenoids, relays, DC motors, battery chargers, and DC-to-DC converters.

- 36, 48, or 75 VDC outputs
- Isolated 100/240 VAC input
- Secondary fuse protection
- Made in USA

### SureStep® Unregulated Open Frame Linear Power Supplies



Starting at  
**\$159.00**  
(STP-PWR-3204)

SureStep unregulated open frame linear power supplies offer full load outputs of 32 VDC/4A, 48 VDC/5A, 48 VDC/10A, 70 VDC/5A; and are perfectly suited to provide power for stepper drives and stepper motors.

- 120/240 VAC selectable input
- Less susceptible to motor regeneration than switching supplies
- Fusing included for both incoming AC and outgoing DC
- All models have an additional 5 VDC, 500 mA regulated logic supply with electronic overload protection

## Open Frame Power Supplies

Open frame switching power supplies are a compact, inexpensive option for DC power needs. With up to 90 Watts of output power, these flexible power supplies require only convection cooling for full-power operation. Units with UPS functionality are available.



Starting at  
**\$35.50**  
(PSFA24-060-U)

### PSFA Series

- Offers battery switchover capability
- Output Power: 60 W

### FA Series

- Hazardous location rating at a low cost
- Output Power: 30 to 89 W

## Reliable DC-to-DC Converters

### What is a DC-to-DC converter?

DC-to-DC converters provide reliable, overload and short-circuit protected, adjustable outputs when an application requires a different DC voltage than what is readily available. They have excellent voltage regulation, taking a varying input voltage and providing a stable output voltage. They isolate sensitive electronic equipment and can filter spikes, noise, and ripple in problem circuits.

## DIN Rail Mount DC-to-DC Converters

RHINO and WAGO DIN-rail mount DC-to-DC converters accept a wide range of DC source inputs and convert them to the required voltage levels. Slim-case models are perfect for space limited applications; an isolated converter helps eliminate ground loops.



Starting at  
**\$52.50**  
(2000-5420-1399-0987)

### RHINO PSP Series

Features a wide input range to support all popular DC voltage systems

### RHINO FA-DCDC-1 Series

Eliminates ground loops and addresses isolation issues when interfacing to PLC analog I/O modules

### WAGO Terminal Block Style

Terminal-block style DC-to-DC converters optimize cabinet space

### WAGO PNP/NPN Converter

Easily convert a signal from PNP to NPN or vice-versa

## Encapsulated Chassis Mount DC-to-DC Converters

Encapsulated DC-to-DC converters provide maximum environmental protection for reliable DC power. These low-profile, plastic and aluminum housed units accept a wide range of DC inputs and convert them to the needed voltage levels, and offers features such as remote on/off control and overload protection.



### PSE Series DC-to-DC Converters

RHINO PSE Series DC-to-DC converters offer ultra-wide input voltage ranges that allow these models to operate from all popular DC supply voltage systems.



Starting at  
**\$86.00**  
(PSE05-DC12-40)



Starting at  
**\$199.00**  
(PSRP-12-DC24-150)



### PSRP Series DC-to-DC-Converters

RHINO PRO industrial DC-to-DC converters feature robust protection ratings, such as high EMC immunity, shock and vibration resistance, and thermal shock resistance. They provide constant current output at 100% load and are ideal for battery charging applications.



# Specialty Modules

RHINO specialty modules for DC power supplies include redundancy, buffer, and battery control modules to provide steady, reliable power even through a power failure. Build a backup system or DC UPS with these practical, low-cost modules.

## Battery Control Modules

The battery control module, when combined with a DC power supply, makes a perfect DC UPS (uninterruptible power system) by providing the means to charge and monitor an external lead acid battery.

- For use with 24 VDC or 48 VDC (PSH only) bus voltages; 12 or 24 volt battery
- Redundant inputs or can be paired with RHINO redundancy modules for more reliable power systems
- Battery protection for over voltage, over current, over temperature, deep discharge, reverse connection and battery overcharge
- 7.5, 10, 15 and 40A ratings
- DIN rail mounted
- Universally compatible battery controller modules available

FREE Shipping - Orders over \$49  
2-day Shipping

45-day Money-Back Guarantee  
45 day

FREE Technical Support  
Located in USA

Battery Control Module Feature Comparison								
Series	Price	Case	Compatibility	# of Inputs	Battery Type	Temperature Sensor Compatible	UL	Output Voltage/ Amp/Power Rating
PSB	\$66.00	Metal	Universal	One power supply	24V sealed lead acid	X	✓	24 VDC / 40A / 960W
PSL	\$34.50	Low-Profile, Plastic	Universal	One power supply	24V sealed lead acid	X	✓	24 VDC / 10A / 240W
PSM	\$196.00	Metal	Requires RHINO PSM24 power supply	One power supply	24V sealed lead acid	✓	X	24 VDC / 15A / 360W
PSH	\$242.00	Metal	Universal	Redundant inputs for two independent power supplies	12V sealed lead acid	✓	X	24 VDC / 15A / 360W 48 VDC / 7.5 A / 360W

Starting at \$34.50 (PSL-24-BCM240)



PSH Series

PSM Series

PSL Series

PSB Series

## Buffer Modules

The buffer module will maintain the output voltage of a 24 VDC power supply after brownouts or voltage dips for up to 4 seconds depending on load.

- Corrosion-resistant aluminum housing available
- Connect modules in parallel to increase buffering time
- Class 1 Division 2 hazardous location ratings offered
- Storage capacity does not deteriorate over the lifetime of the unit
- Start buffering voltage adjustment (switch or potentiometer)
- Alarm contact for operation monitoring
- Remote on/off

Starting at \$129.00 (PSB24-BFM20S)



Buffer Module Feature Comparison							
Series	Price	Buffer time	Case	Mount	Hazardous Location Rated	Protection Type	Output Voltage/ Amp Rating
PSB	\$129.00	250 msec hold-up at 20A or 5 sec at 1A	Metal	DIN Rail	✓	Overvoltage Overcurrent	24 VDC / 20A
PSM	\$231.00	200 msec hold-up at 25A or 4 seconds at 1.2A	Metal	DIN Rail	X	X	24 VDC / 25A

## Redundancy Modules

The RHINO redundancy modules are used with two power supplies in parallel to create a redundant supply to prevent costly downtime due to power supply failure.

- Even if one power supply fails or becomes disconnected, the second power supply unit will supply the full current to the load
- Class 1 Division 2 hazardous location ratings offered
- Wide input and output ranges
- Active current sharing (PSM only)

Starting at \$41.00 (PSB60-REM20S)



Redundancy Module Feature Comparison									
Series	Price	Requires	Case	Mount	Agency Approvals	Protection Type	Alarm Contact	Input Voltage	Output Voltage/ Amp Rating
PSB	Starting at \$41.00	(2) PSB24 or PSB48 power supplies	Metal	DIN Rail	UL Haz Loc Listed, UL Listed, CE, CSA	Overcurrent	✓	24/48 VDC	24/48 VDC / 20A or 24/48 VDC / 40A
PSP	\$59.00	(2) PSP24 power supplies	Plastic	DIN Rail / Panel	UL Listed, CE	X	X	5/12/24 VDC	5/12/24 VDC / 8A
PSM	\$199.00	2) PSM24 power supplies	Metal	DIN Rail	CE	X	✓	24 VDC	24 VDC / 15A

# Dealing with Low-voltage Power Issues

When a power failure brings a manufacturing process down, it can cost thousands of dollars. As a result, companies turn to redundancy modules, buffer modules, and battery backup systems to protect their sensitive electronic equipment from power issues do not offer power loss protection. Redundant systems fail when the main power is lost.

## Redundancy Modules

In a critical process, a power supply failure can be a serious concern, even if the facility has stable incoming power. In this case, a wise solution would be to use a redundancy module. Redundancy modules monitor parallel power supplies and switch to the backup when a failure occurs. The main drawback to using redundancy systems is they do not offer power loss protection. Redundant systems fail when the main power is lost.

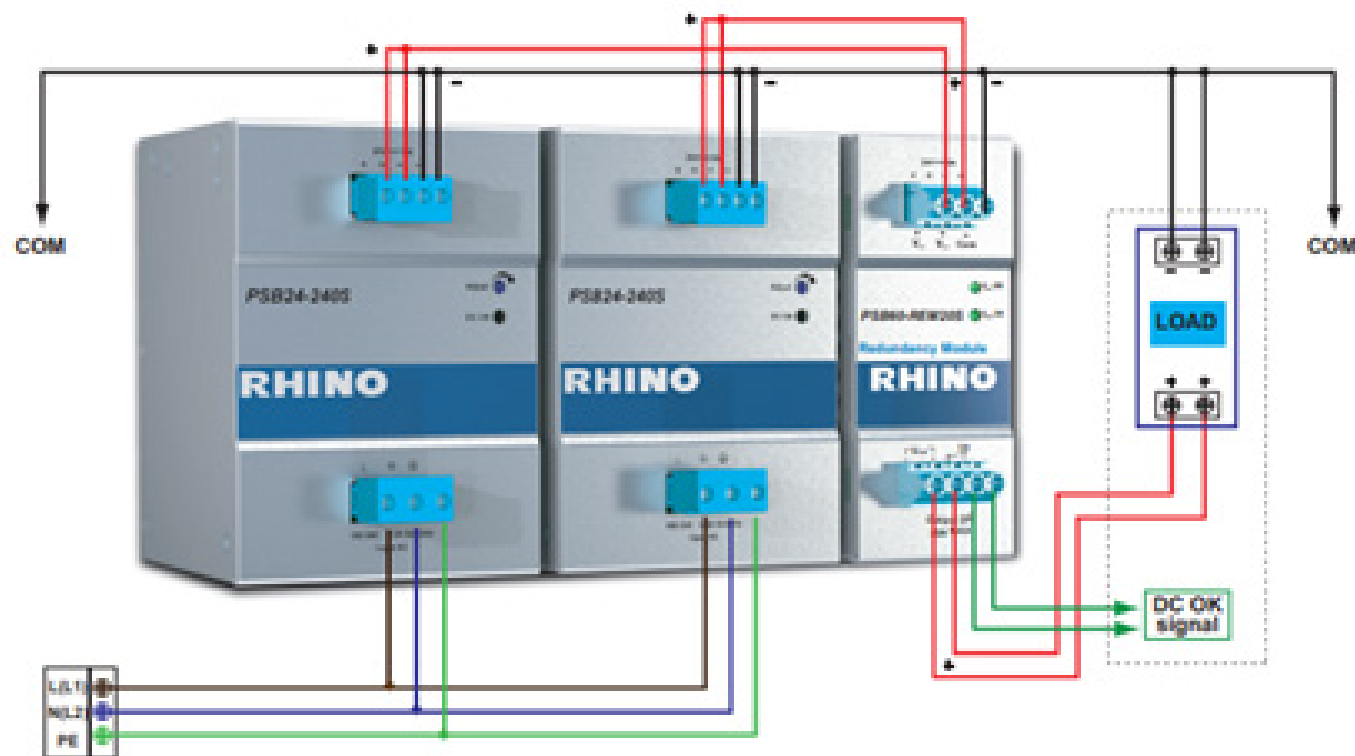

RHINO PSB60-REM series redundancy module connected to two 240 W power supplies

## Buffer Modules

A buffer module keeps a system running smoothly, even with frequent voltage drops and brownouts. It consists of large capacitive banks that release energy when a power failure occurs. The module, installed in parallel with a power supply, provides backup when a power failure occurs. It is maintenance-free because there are no moving parts, and its storage capability does not deteriorate over time.

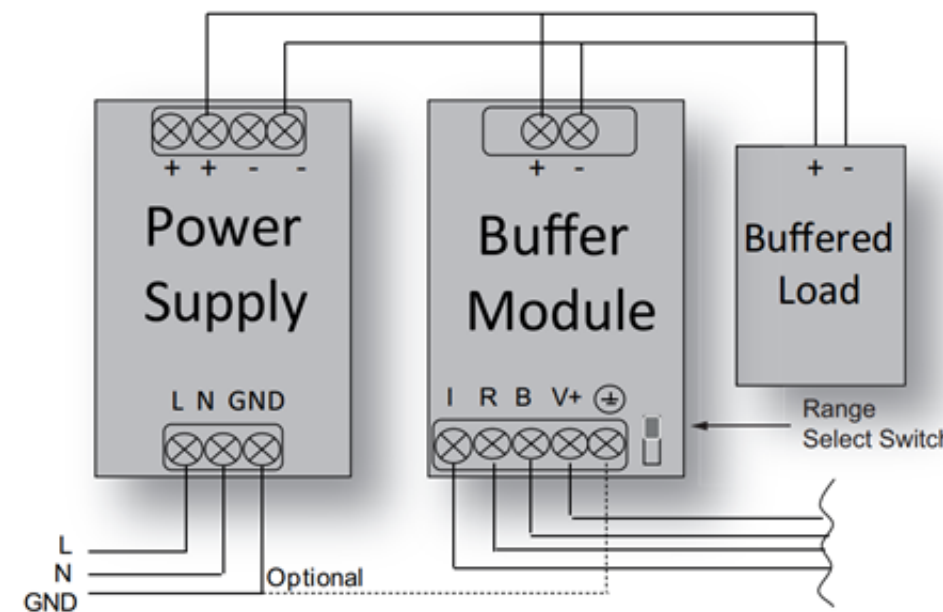

Wiring diagram for a Buffer Module connected between a power supply and load

## Battery Backup System

A battery backup system is required when there are frequent power issues, especially if the process is in a remote location. It consists of a power supply, battery backup module, batteries, and optional monitoring equipment. The power supply keeps the battery charged under normal conditions, then seamlessly switches to battery operation on power loss. This system provides the most robust protection and covers the broadest range of power faults.

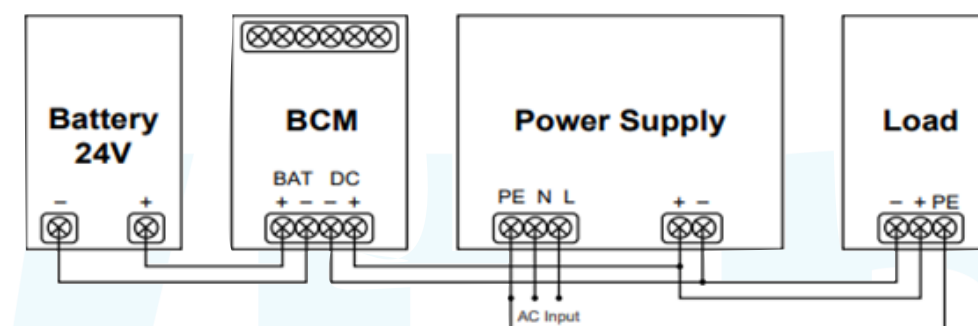

Battery Control Module wiring diagram

As power systems grow increasingly taxed, you can depend on auxiliary protection modules to keep processes running to their fullest potential.



# Electronic Circuit Breakers

Electronic circuit breakers protect electrical circuits from overcurrent and short-circuit faults. They use solid-state components and advanced algorithms to quickly sense and interrupt the current flow, minimizing the duration of a fault and reducing the potential for damage to the electrical system. They provide improved reliability, accuracy, and flexibility compared to traditional counterparts and offer advanced features, such as: adjustable trip characteristics, remote signaling, and thermal-magnetic or electronic trip units.

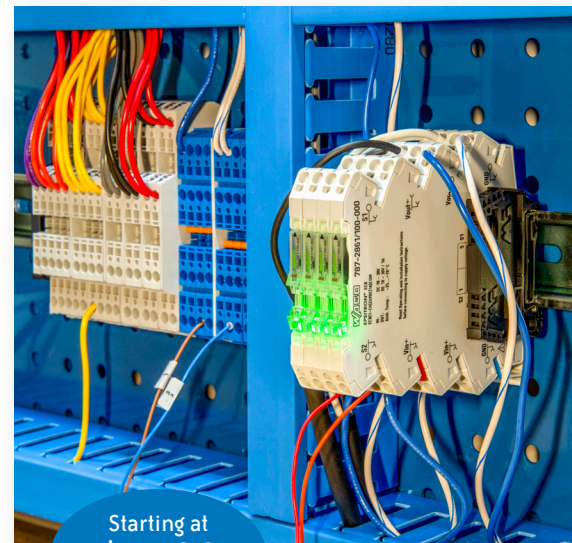

## WAGO Single-Channel Electronic Circuit Breakers

WAGO single-channel ECBs provide electronic circuit protection for 24 VDC circuits in a slim package. They are much smaller than comparably sized circuit breakers, saving even more space, particularly when used in control cabinets. These ECBs enable high-capacitive loads greater than 50,000 microfarads to be switched on – helping you reduce false tripping due to inrush currents.

- Space-saving ECB with one channel
- This model safely and reliably stops power in the event of an overload or if it short circuits on the secondary side
- 24 VDC, six versions available for rated currents of 1 to 8 A
- Switch-on capacity: >50,000  $\mu$ F
- Minimizes wiring via two voltage outputs and maximizes commoning options in both input and output sides
- Switch the breaker on or off via remote input, or a local switch
- Bus up to 10 units together with the use of Jumper Bars

Starting at  
**\$57.00**  
(787-2861-800-000)

## WAGO Multi-Channel Electronic Circuit Breakers

WAGO's space-saving ECBs provide reliable protection of 24 VDC circuits. They offer outstanding features and reliable protection against overload and short circuits. These ECBs feature high channel density to save space in the control cabinet.

- Space-saving ECBs with two-, four- and eight-channel protective switch with currents adjustable from 0.5 to 10 A
- NEC Class 2 3.8A fixed models available
- High switch-on capacity: > 50,000  $\mu$ F
- Remote input resets tripped channels or switches on/off any number of channels via pulse sequence
- Optional active current limitation
- Easy-to-use Push-In CAGE CLAMP terminals
- Approvals: CE, UL 60950, UL 2367, DNV GL



Starting at  
**\$183.00**  
(787-1662-106-000)

# Electronic Circuit Protectors

## E-T-A® Modular Electronic Circuit Protectors

E-T-A REX protectors safeguard electrical circuits from overcurrent, short circuit, and other faults. Designed to create a modular system, individual protection modules can be combined to meet specific circuit protection requirements, allowing for flexible configurations and easy installation.

Components Starting at  
**\$11.00**  
(EM-T00-000-GND-40A)

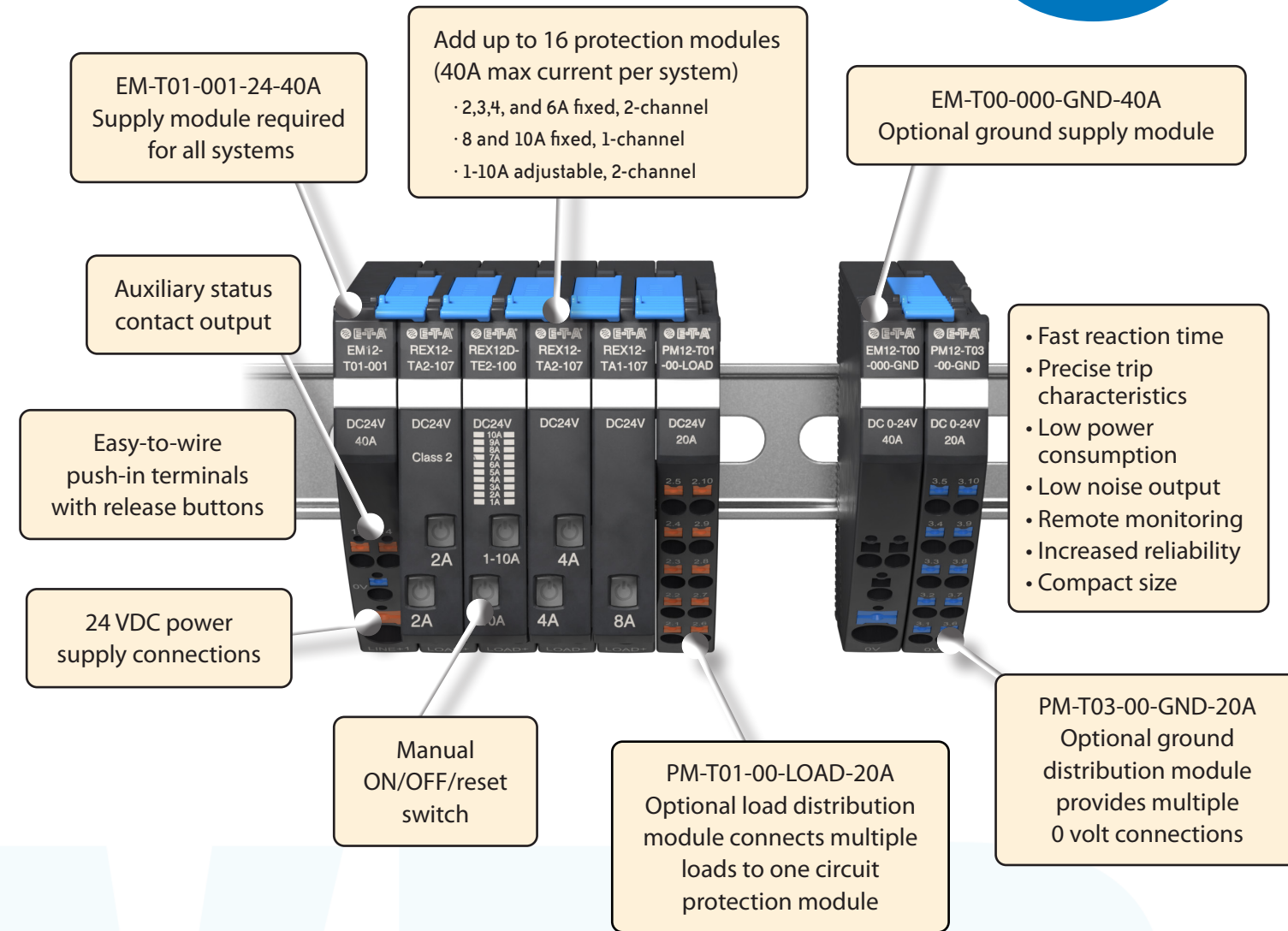

### Features

- Modular system
- Electronic trip curves
- Slim 12.5mm module width
- Integral fail-safe element, adjusted to max. current rating
- Rated for capacitive loads up to 20,000  $\mu$ F

# Gladiator<sup>®</sup> GECP Series Circuit Protectors

Gladiator GECP series circuit protectors can be customized to fit the needs of any application, featuring an adjustable trip current range, adjustable trip characteristics, and LED signaling with output alarms for real-time status monitoring. The GECP series is compact, lightweight, and available at a very low cost per channel.

- Protection modules are standalone or can be integrated into a modular system using supply and ground modules
- Adjustable module offers adjustable trip current range (1-10A) and trip characteristics
- 10 to 30 VDC operating voltage
- LED signaling at 90% overload provides early warning of potential overloads, allowing corrective action to be taken before a fault occurs
- Remote set/reset for applications where access to the breaker is difficult or dangerous
- Bus up to 8 modules together using jumper bars



Starting at  
**\$37.00**  
(GECP-1CH-1A)

