



# XGB Communication Modules

## XBL-EIPT Communication Module

This module is used for EtherNet/IP communications. Built in switch functionality and tag based communication configuration make setup easy. The module supports:

- Symbolic Addressing (ANSI Extended Symbol Segment)
- Class 1 Connected Implicit(I/O)Messaging(Cyclic I/O Service Only)
- Class 3 Connected Explicit Messaging(Server Only)
- UCMM Explicit Messaging,

Part Number	Price	Classification	Description	Drawing
<b>XBL-EIPT</b>	\$199.00	Ethernet Communications	LS Electric XGB communication module, EtherNet/IP, 2 ports, (2) Ethernet 10/100Base-T (RJ45) port(s). For use with LS Electric XGB series PLCs.	PDF

General Specifications		XBL-EIPT
<b>Transmission Standard</b>	<b>Speed</b>	100Mbps
	<b>Method</b>	Base band
	<b>Maximum Extension Distance between Nodes</b>	100m
	<b>Communication Zone Excess Method</b>	CSMA/CD
	<b>Frame Error-Checking Method</b>	CRC 32 = $X^{32}+X^{26}+X^{23}+...+X^2+X+1$
<b>Topology</b>		Line, Star
<b>Diagnosis Function</b>		Module information, service state, media information, auto scan, ping test
<b>Service</b>	<b>Periodic Client</b>	Implicit I/O Client
	<b>Aperiodic Client</b>	UCMM Client
	<b>Periodic Server</b>	Implicit I/O Server
<b>Number of Connections (Client/Server)</b>	<b>TCP</b>	16/32
	<b>CIP (I/O Communication)</b>	32/64
<b>Maximum Number of Services</b>		2
<b>Maximum Units per CPU</b>		2
<b>Maximum Setting Data Size Per Block</b>	<b>Periodic Client</b>	500 byte
	<b>Aperiodic Client</b>	512 byte
<b>Media</b>		UTP/STP Category 5
<b>Current Consumption</b>		290mA
<b>Weight</b>		102g
<b>Requirements</b>		XG5000 version 4.76_2024-02-22 or later XEM Dx32Hx series PLC with firmware v2.4 or later

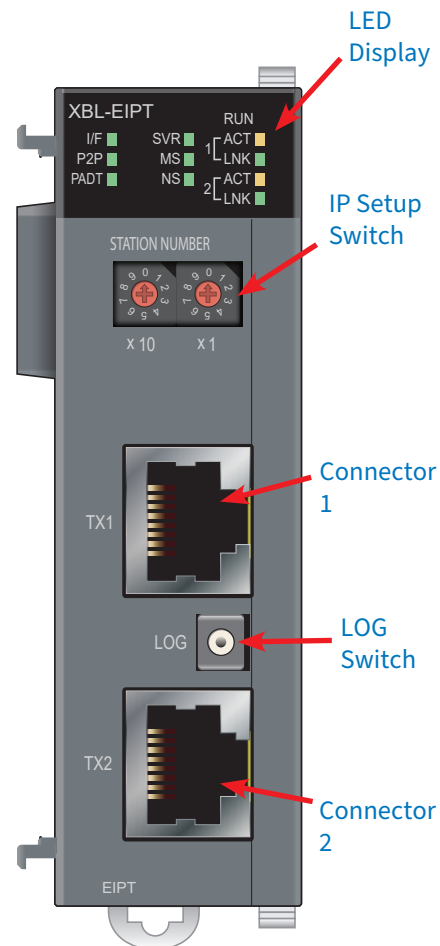

## XBL-EIPT Communication Module Interface

### Device LED Functionality

Faceplate View	LED	Status	Meaning
	RUN	ON	Power ON and process normally operating.
		OFF	Power OFF and process abnormally operating.
	I/F	Blink	I/F operating normally with CPU.
		Flicker/OFF	I/F operating abnormally with CPU.
	P2P	ON	P2P service is enabled
		OFF	P2P service is disabled
	PADT	ON	XG5000 connected via remote control.
		OFF	XG5000 remote connection is disabled
	SVR	ON	Exterior client connected.
		OFF	No exterior client connected.
	MS	Green Light ON	Normal operation.
		Green Light flickers	Device configuration in progress.
		Red Light flickers	Incorrect setup or restorable errors.
		Red Light ON	Unrestorable errors.
		Red/Green Light flickers	Self-diagnosis in progress.
	NS	Green Light flickers	No connection to device.
		Green Light ON	Connection with at least 1 device.
		Red Light flickers	Device timeout occurred.
		Red Light ON	Identical IP addresses detected.
		Red/Green Light flickers	Self-diagnosis in progress.
nACT	Flicker	In case of frame - transmitted and received (n=1,2)	
nLNK	ON	Network link established (n=1,2)	
	OFF	No network link (n=1,2)	

### Device Switch Functionality

Faceplate View	Name	Setting	Function
	<b>Log Switch</b>	Push for > 1s	Press the Log Switch for at least 1 second to store the communication module log to the Flash Area Log. Data in the Flash Area Log is maintained during power cycling. Otherwise, the communication module log is stored to the Memory Area Log and will be erased when the power cycles.
	<b>Station Number (IP setup)</b>	1-90, 94-99	If an IP address is not assigned by the XG5000 software, an IP address will be assigned based as "192.168.250.switch value".
		91-93	Internal configuration only. Do not Use.
		99	For Ring configuration. See User Manual for more information.

### Device Software Configuration

Visit the quick start tutorial for EtherNET/IP card setup and implicit/explicit connection configuration:

[https://cdn.automationdirect.com/static/helpfiles/ls\\_plc/Content/C\\_ProcedureTopics/LP200.htm](https://cdn.automationdirect.com/static/helpfiles/ls_plc/Content/C_ProcedureTopics/LP200.htm)

## Environmental Specifications, all XGB Series Modules

Item		Specification	Reference	
Ambient Operating Temperature		0–55°C (32–131°F)	-	
Storage Temperature		-25–70°C (-13–158°F)		
Ambient Operating Humidity		5–95% relative humidity (non-condensing)		
Storage Humidity		5–95% relative humidity (non-condensing)		
Vibration <sup>1</sup>	Occasional Vibration	5 ≤ f < 8.4 Hz	IEC61131-3-2	
		8.4 ≤ f < 150Hz		
	Continuous Vibration	5 ≤ f < 8.4 Hz		
		8.4 ≤ f < 150Hz		
Shocks		Peak Acceleration		147 m/s <sup>2</sup> (15G)
		Duration		11ms
		Pulse Wave Type	Half-sine (3 times each direction per each axis)	
Noise Resistance	Square Wave Impulse Noise		1,500VAC 900VDC	LS Electric standard
	Electrostatic Discharge		Voltage: 4kV (contact discharge)	IEC61131-3-2 IEC61000-4-2
	Radiated Electromagnetic Field Noise		80–1,000 MHz, 10 V/m	IEC61131-3-2 IEC61000-4-3
	Fast Transient / Burst Noise	Classification	Voltage	IEC61131-3-2 IEC61000-4-4
		Power Supply	2kV	
Digital/Analog Input/Output Communication Interface		1kV		
Environment		Free from corrosive gases and excessive dust	-	
Attitude		Less than 2,000m		
Pollution Degree		Less than 2 (see note 2)		
Cooling Method		Air-cooling		

1 - Vibration of 10 times each direction (X, Y, and Z)

2 - Normally only nonconductive pollution occurs. Temporary conductivity caused by condensation is to be expected.



# XGB Series PLC Family

## Available I/O Modules

XGB Series I/O Modules									
Part Number	Price	Description	Digital Input	Digital Output	Analog Input	Analog Output	Motion	Bus Coupler Compatible	Smart Link Required
<b>Digital</b>									
<a href="#"><u>XBE-DC08A</u></a>	\$59.00	LS Electric XGB discrete input module, 8-point, 24 VDC, sinking/sourcing, 1 common(s), 8 point(s) per common. Removable terminal block included.	✓					✓	
<a href="#"><u>XBE-DC16A</u></a>	\$70.00	LS Electric XGB discrete input module, 16-point, 24 VDC, sinking/sourcing, 1 common(s), 16 point(s) per common. Removable terminal blocks included.	✓					✓	
<a href="#"><u>XBE-DC16B</u></a>	\$78.00	LS Electric XGB discrete input module, 16-point, 12-24 VDC, sinking/sourcing, 1 common(s), 16 point(s) per common. Removable terminal blocks included.	✓					✓	
<a href="#"><u>XBE-DC32A</u></a>	\$97.00	LS Electric XGB discrete input module, 32-point, 24 VDC, sinking/sourcing, 1 common(s), 32 point(s) per common. Requires XTB-40H terminal block and C40HH-xxSB-XBI cable.	✓					✓	✓
<a href="#"><u>XBE-AC08A</u></a>	\$88.00	LS Electric XGB discrete input module, 8-point, 120 VAC, 2 common(s), 4 point(s) per common. Removable terminal blocks included.	✓					✓	
<a href="#"><u>XBE-RY08A</u></a>	\$80.00	LS Electric XGB relay output module, 8-point, 125 VDC/250 VAC, (8) Form A, 1 common(s), 8 point(s) per common, 2A/point, 5A/common. Removable terminal block included.		✓				✓	
<a href="#"><u>XBE-RY08B</u></a>	\$95.00	LS Electric XGB relay output module, 8-point, 125 VDC/250 VAC, (8) Form A, 8 isolated common(s), 1 point(s) per common, 2A/point. Removable terminal blocks included.		✓				✓	
<a href="#"><u>XBE-RY16A</u></a>	\$110.00	LS Electric XGB relay output module, 16-point, 125 VDC/250 VAC, (16) Form A, 2 isolated common(s), 8 point(s) per common, 2A/point, 5A/common. Removable terminal blocks included.		✓				✓	
<a href="#"><u>XBE-TN08A</u></a>	\$60.00	LS Electric XGB discrete output module, 8-point, 12-24 VDC, sinking, 1 common(s), 8 point(s) per common, 0.5A/point, 2A/common. Removable terminal blocks included.		✓				✓	
<a href="#"><u>XBE-TN16A</u></a>	\$78.00	LS Electric XGB discrete output module, 16-point, 12-24 VDC, sinking, 1 common(s), 16 point(s) per common, 0.5A/point, 2A/common. Removable terminal blocks included.		✓				✓	
<a href="#"><u>XBE-TN32A</u></a>	\$109.00	LS Electric XGB discrete output module, 32-point, 12-24 VDC, sinking, 1 common(s), 32 point(s) per common, 0.2A/point, 2A/common. Requires XTB-40H terminal block and C40HH-xxSB-XBI cable.		✓				✓	✓
<a href="#"><u>XBE-TP08A</u></a>	\$62.00	LS Electric XGB discrete output module, 8-point, 12-24 VDC, sourcing, 1 common(s), 8 point(s) per common, 0.5A/point, 2A/common. Removable terminal blocks included.		✓				✓	
<a href="#"><u>XBE-TP16A</u></a>	\$88.00	LS Electric XGB discrete output module, 16-point, 12-24 VDC, sourcing, 1 common(s), 16 point(s) per common, 0.5A/point, 2A/common. Removable terminal blocks included.		✓				✓	
<a href="#"><u>XBE-TP32A</u></a>	\$93.00	LS Electric XGB discrete output module, 32-point, 12-24 VDC, sourcing, 1 common(s), 32 point(s) per common, 0.2A/point, 2A/common. Requires XTB-40H terminal block and C40HH-xxSB-XBI cable.		✓				✓	✓
<a href="#"><u>XBE-DN32A</u></a>	\$172.00	LS Electric XGB discrete combo module, Input: 16-point, 24 VDC, sinking/sourcing, Output: 16-point, 12-24 VDC, sinking, 0.2A/point, 2A/common. Requires XTB-40H terminal block and C40HH-xxSB-XBI cable.	✓	✓				✓	✓
<a href="#"><u>XBE-DR16A</u></a>	\$97.00	LS Electric XGB discrete combo module, Input: 8-point, 24 VDC, sinking/sourcing, Output: 8-point, 125 VDC/250 VAC, relay, (8) Form A (SPST) relays, 2A/point, 5A/ common. Removable terminal blocks included.	✓	✓				✓	
<b>Motion</b>									
<a href="#"><u>XBF-PN04B</u></a>	\$350.00	LS Electric XGB 4-axis positioning module, EtherCAT Master, 1 high-speed input point(s), sinking/line driver (differential), 1-channel, differential and single-ended encoder input(s), (1) Ethernet 100Base-TX (RJ45) port(s). For use with LS Electric XEM-DxxxHx PLCs.					✓		
<a href="#"><u>XBF-PN08B</u></a>	\$395.00	LS Electric XGB 8-axis positioning module, EtherCAT Master, 1 high-speed input point(s), sinking/line driver (differential), 1-channel, differential and single-ended encoder input(s), (1) Ethernet 100Base-TX (RJ45) port(s). For use with LS Electric XEM-DxxxHx PLCs.					✓		
<a href="#"><u>XBF-HO02A</u></a>	\$176.00	LS Electric XGB counter input module, 200 kHz maximum switching frequency, 2 high-speed input point(s), 5-24 VDC, sinking, 2-channel, single-ended encoder input(s), 2 high-speed output point(s), 5-24 VDC, sinking, external 24 VDC required.					✓	✓	✓
<a href="#"><u>XBF-HD02A</u></a>	\$253.00	LS Electric XGB counter input module, 500 kHz maximum switching frequency, 2 high-speed input point(s), 5-24 VDC, sinking, 2-channel, differential encoder input(s), 2 high-speed output point(s), 5-24 VDC, sinking, external 24 VDC required.					✓	✓	✓

Note: See "Smart Link I/O System" on page tLSE-131 for the XTB-40H terminal block and cables. See "XGB PLC Replacement Terminals" on page tLSE-149 for replacement removable terminal blocks.

Continued on next page