

# EATON WMZT Miniature Circuit Breakers



## Overview

Eaton WMZT miniature circuit breakers offer optimum and efficient protection for branch and control circuits up to 40 amps. The WMZT series is available with C or D trip characteristics in accordance with UL489. These circuit breakers are current limiting, which means they interrupt fault currents within one half cycle of the fault. The WMZT series is DIN-rail mountable and can be used in branch circuit applications.

## Listings

- UL Listed and Recognized under UL 489  
Category DIVQ File E7819  
Category DKS Y2 File E7819  
Category DIHS E64983
- CSA 22.2, No. 5 File 245545
- CE LVD 2006/95/EC
- IEC/EN 60947-2



## Features and Benefits

- Complete range of UL489 listed DIN rail mounted miniature circuit breakers up to 40 ampere current rating
- Single pole, two-pole and three pole models
- Current limiting design provides fast short circuit interruption that reduces the let-through energy, which can damage the circuit
- Suitable for branch circuit device protection
- Thermal-magnetic overcurrent protection — two levels of short circuit protection, categorized by C and D curves
- **C curve magnetic trip point:** 5 to 10 times the rated current, typically used for small transformers, pilot devices, etc.
- **D curve magnetic trip point:** 10 to 20 times the rated current, typically used for transformers or loads with very high inductive loads.
- Trip-free design — breaker cannot be defeated by holding the handle in the “ON” position
- Captive screws cannot be lost
- SWD (switching duty) rated circuit breaker — suitable for switching fluorescent lighting loads ( $I_n \leq 20A$ )
- Fulfills UL 489, CSA C22.2 No.5 and also IEC 60947-2 Standard
- Can also be used in applications for which UL 1077 or CSA C22.2 No.235 are also allowed
- Field installable shunt trip and auxiliary switch subsequent mounting (See Allowable Combinations page)
- Module width of only 17.7 mm (per pole)
- Contact position indicator (red / green)
- 35mm DIN-rail mountable, utilizing spring clip
- Suitable for reverse feed applications

## Applications

Feeder and Branch Circuit Protection

- Convenience receptacle circuits (internal / external)
- Motor control circuits
- Load circuits leaving the equipment (external)
- HACR Equipment (Heating Air Conditioning, Refrigeration)
- PLC I/O points
- Computers
- Power supplies
- Control instrumentation
- Relays
- UPS
- Power conditioners

# EATON WMZT Miniature Circuit Breakers

Company Information

Terminal Blocks

Power Distribution Blocks

Wiring Accessories

ZIPLink Connection System

Multi-wire Connectors

Sensor Cables and Connectors

M12 Junction Blocks

Panel Interface Connectors

Wiring Duct

Cable Ties

Wire

Flexible Cord

Multi-conductor Flex Cable

Data Cables

Wire Management Products

Power Supplies

DC Converters

Transformers and Filters

Circuit Protection

Tools

Test Equipment

Enclosures

Enclosure Climate Control

Safety: Electrical Components

Safety: Protective Wear

Terms and Conditions

## Tripping Characteristics

Eaton WMZT miniature circuit breakers are available with "C" and "D" tripping characteristics.

Type C trip curve: 5 to 10  $I_n$

C-curve devices are suitable for applications where medium levels of inrush current are expected. Applications include small transformers, lighting, pilot devices, control circuits and coils. C-curve devices provide a medium magnetic trip point.

Type D trip curve: 10 to 20  $I_n$

D-curve devices are suitable for applications where high levels of inrush current are expected. The high magnetic trip point prevents nuisance tripping in high inductive applications such as motors, transformers and power supplies.

Eaton WMZT devices are current limiting, which means they interrupt fault currents within one half cycle of the fault. Current limiting devices offer superior protection by reducing peak let-through current and energy.

## Labeling

The front of each Eaton WMZT miniature circuit breaker is labeled for positive identification.

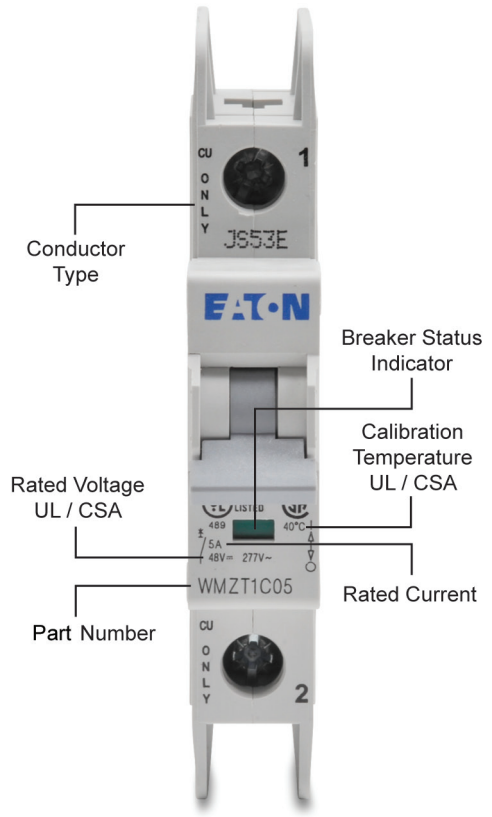
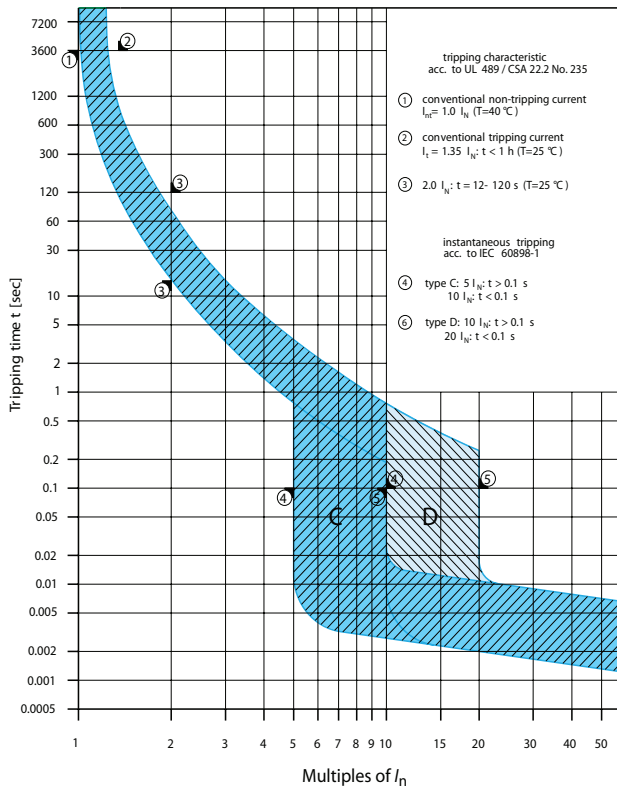

# EATON WMZT Series Selection Guide



Single-Pole

WMZT - Single-Pole Selection Guide				
Ampere Rating	C Curve Part Number	Price	D Curve Part Number	Price
0.5	WMZT1CX0	\$18.00	WMZT1DX0	\$18.00
1	WMZT1C01		WMZT1D01	
1.5	WMZT1CX1		WMZT1DX1	
2	WMZT1C02		WMZT1D02	
3	WMZT1C03		WMZT1D03	
4	WMZT1C04		WMZT1D04	
5	WMZT1C05		WMZT1D05	
6	WMZT1C06		WMZT1D06	
7	WMZT1C07		WMZT1D07	
8	WMZT1C08		WMZT1D08	
10	WMZT1C10		WMZT1D10	
13	WMZT1C13		WMZT1D13	
15	WMZT1C15		WMZT1D15	
16	WMZT1C16		WMZT1D16	
20	WMZT1C20		WMZT1D20	
25	WMZT1C25		WMZT1D25	
30	WMZT1C30		WMZT1D30	
32	WMZT1C32		WMZT1D32	
*40	WMZT1C40		WMZT1D40	

\* Rated 240VAC



Two-Pole

WMZT - Two-Pole Selection Guide				
Ampere Rating	C Curve Part Number	Price	D Curve Part Number	Price
0.5	WMZT2CX0	\$35.00	WMZT2DX0	\$35.00
1	WMZT2C01		WMZT2D01	
1.5	WMZT2CX1		WMZT2DX1	
2	WMZT2C02		WMZT2D02	
3	WMZT2C03		WMZT2D03	
4	WMZT2C04		WMZT2D04	
5	WMZT2C05		WMZT2D05	
6	WMZT2C06		WMZT2D06	
7	WMZT2C07		WMZT2D07	
8	WMZT2C08		WMZT2D08	
10	WMZT2C10		WMZT2D10	
13	WMZT2C13		WMZT2D13	
15	WMZT2C15		WMZT2D15	
16	WMZT2C16		WMZT2D16	
20	WMZT2C20		WMZT2D20	
25	WMZT2C25		WMZT2D25	
30	WMZT2C30		WMZT2D30	
32	WMZT2C32		WMZT2D32	
*40	WMZT2C40		WMZT2D40	

\* Rated 240VAC

Note: Eaton parts available for sale to North America locations only.

# EATON WMZT Series Selection Guide

Company Information

Terminal Blocks

Power Distribution Blocks

Wiring Accessories

ZIPLink Connection System

Multi-wire Connectors

Sensor Cables and Connectors

M12 Junction Blocks

Panel Interface Connectors

Wiring Duct

Cable Ties

Wire

Flexible Cord

Multi-conductor Flex Cable

Data Cables

Wire Management Products

Power Supplies

DC Converters

Transformers and Filters

Circuit Protection

Tools

Test Equipment

Enclosures

Enclosure Climate Control

Safety: Electrical Components

Safety: Protective Wear

Terms and Conditions

WMZT - Three-Pole Selection Guide				
Ampere Rating	C Curve Part Number	Price	D Curve Part Number	Price
0.5	WMZT3CX0	\$54.50	WMZT3DX0	\$54.50
1	WMZT3C01		WMZT3D01	
1.5	WMZT3CX1		WMZT3DX1	
2	WMZT3C02		WMZT3D02	
3	WMZT3C03		WMZT3D03	
4	WMZT3C04		WMZT3D04	
5	WMZT3C05		WMZT3D05	
6	WMZT3C06		WMZT3D06	
7	WMZT3C07		WMZT3D07	
8	WMZT3C08		WMZT3D08	
10	WMZT3C10		WMZT3D10	
13	WMZT3C13		WMZT3D13	
15	WMZT3C15		WMZT3D15	
16	WMZT3C16		WMZT3D16	
20	WMZT3C20		WMZT3D20	
25	WMZT3C25		WMZT3D25	
30	WMZT3C30		WMZT3D30	
32	WMZT3C32		WMZT3D32	
*40	WMZT3C40		WMZT3D40	

\* Rated 240VAC



Three-Pole

Miniature Circuit Breaker - UL / CSA			
		C Curve	D Curve
<b>Short Circuit Trip Response</b>		5 - 10 x I <sub>n</sub>	10 - 20 x I <sub>n</sub>
<b>Current Range</b>		0.5 - 40A	0.5 - 40A
<b>Maximum Voltage Ratings - UL / CSA</b>	0.5 - 32A	277 / 480Y	
	32A	240VAC	
	Per pole	48VDC	
<b>Thermal Tripping Characteristics</b>	Single pole	40°C	
	Multi-pole		
<b>Short Circuit Ratings (At Max. Voltage)</b>	1 pole	10kA	
	2 pole		
	3 pole		
<b>Rated Frequency</b>		50 / 60Hz	

Miniature Circuit Breaker - IEC			
		C Curve	D Curve
<b>Short Circuit Trip Response</b>		5 - 10 x I <sub>n</sub>	10 - 20 x I <sub>n</sub>
<b>Current Range</b>		0.5 - 40A	0.5 - 40A
<b>Maximum Voltage Ratings - IEC/EN 60947-2</b>	1 pole	240 / 415 VAC	
	2 pole		
	3 pole		
<b>Thermal Tripping Characteristics</b>	Single pole	30°C	
	Multi-pole	30°C	
<b>Interrupt Ratings (At Max Voltage)</b>		15kA	
<b>Rated Frequency</b>		50 / 60Hz	

General Specifications - WMZT		
<b>Lifespan / Endurance</b>	≥20,000 (1 operation = ON/OFF)	
<b>Operating Temperature</b>	UL 489, CSA C22.2 No.5 = 40°C IEC 60947-2 = 30°C	
<b>Shock (UL 489)</b>	10g 20-25 ms	
<b>Housing Material</b>	Nylon	
<b>Mounting Position</b>	Vertical	
<b>Weight</b>	One-Pole	0.3 lb (136g)
	Two-Pole	0.6 lb (272g)
	Three-Pole	0.9 lb (408g)

Wire Size - WMZT			
Ampere Rating	Cable Size		
	0.5 - 40	One wire	0.75 to 13 mm <sup>2</sup>
Two wires		0.75 to 5 mm <sup>2</sup>	18 to 10 AWG

**Note:** Eaton does not recommend the use of wire ferrules or crimping terminals. The wire gauges are specified above and in the installation instructions included with each circuit breaker.

Tightening Torque - WMZT		
Cable Size	Tightening Torque	
18 - 12 AWG	2.4 N·m	21 lb·in
10 - 8 AWG	2.8 N·m	25 lb·in
6 AWG	4.1 N·m	36 lb·in

# EATON WMZT Series Technical Data

## Let-Through Energy

**Characteristic C (0.5-20A), 277V**

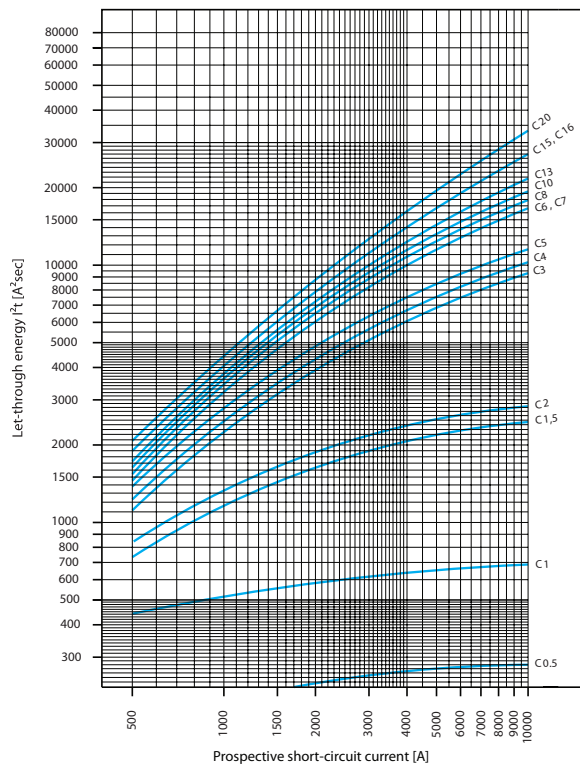

**Characteristic C (25-40A), 240V**

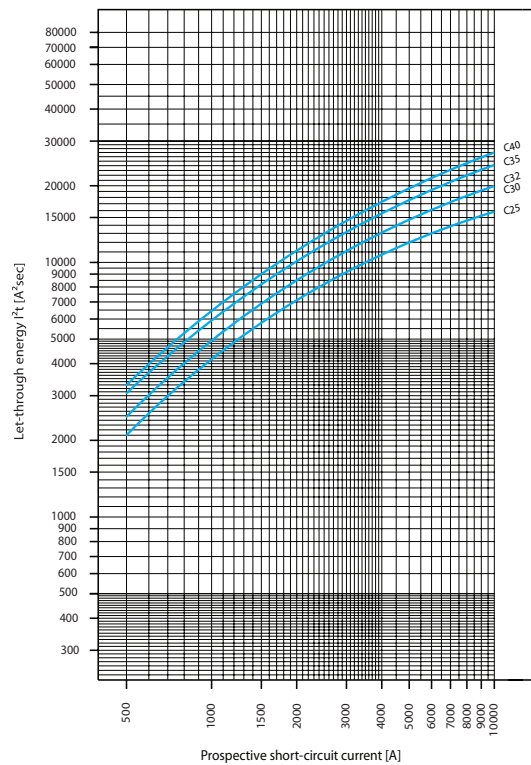

**Characteristic D (0.5-20A), 277V**

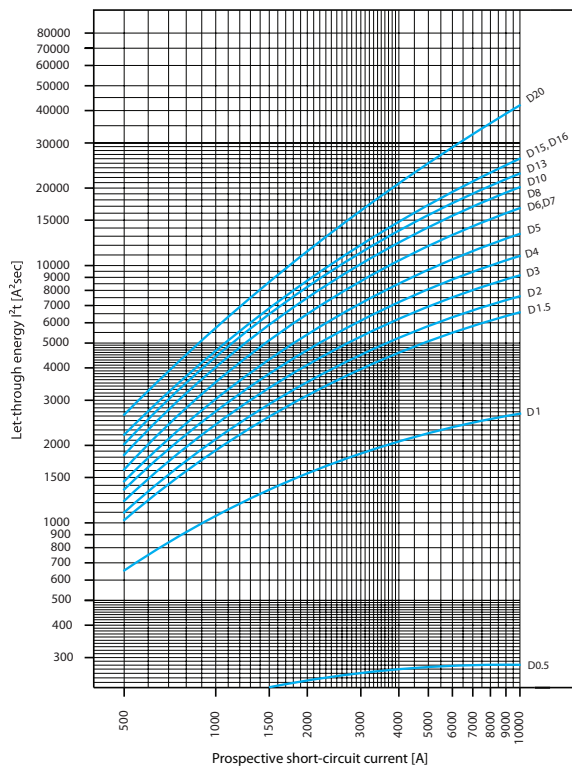

**Characteristic D (25-40A), 240V**

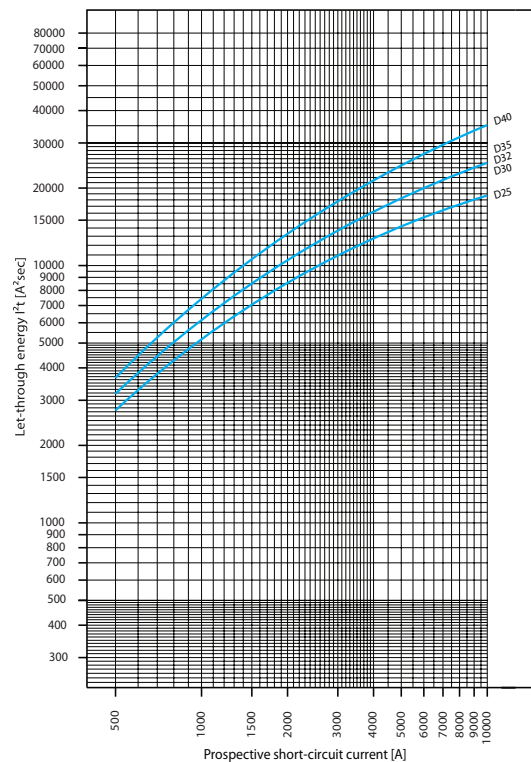

Power Loss at $I_n$			
Characteristic C			
$I_n$ [A]	1p P[W]	2p P[W]	3p P[W]
0.5	1.6	3.2	4.7
1	1.1	2.2	3.4
1.5	1.3	2.6	3.9
2	1.4	2.8	4.3
3	1.2	2.4	3.6
4	1.4	2.9	4.3
5	1.9	3.7	5.6
6	1.2	2.3	3.5
7	1.4	2.8	4.3
8	1.4	2.8	4.2
10	1.8	3.6	5.3
13	2.4	4.7	7.1
15	1.9	3.8	5.6
16	2.1	4.3	6.4
20	2.9	5.8	8.7
25	3.1	6.2	9.3
30	3.0	6.0	9.0
32	3.4	6.8	10.2
40	4.0	8.1	12.1

Power Loss at $I_n$			
Characteristic D			
$I_n$ [A]	1p P[W]	2p P[W]	3p P[W]
0.5	1.6	3.2	4.8
1	0.8	1.5	2.3
1.5	1.0	2.1	3.1
2	1.0	2.1	3.1
3	1.2	2.4	3.6
4	1.4	2.9	4.3
5	1.5	2.9	4.4
6	1.2	2.3	3.5
7	1.4	2.8	4.3
8	1.2	2.4	3.7
10	1.5	3.0	4.5
13	2.0	4.1	6.1
15	1.5	3.1	4.6
16	1.7	3.5	5.2
20	1.8	3.7	5.5
25	2.6	5.1	7.7
30	2.7	5.4	8.1
32	3.1	6.2	9.3
40	3.9	7.8	11.6

## Tripping Curves

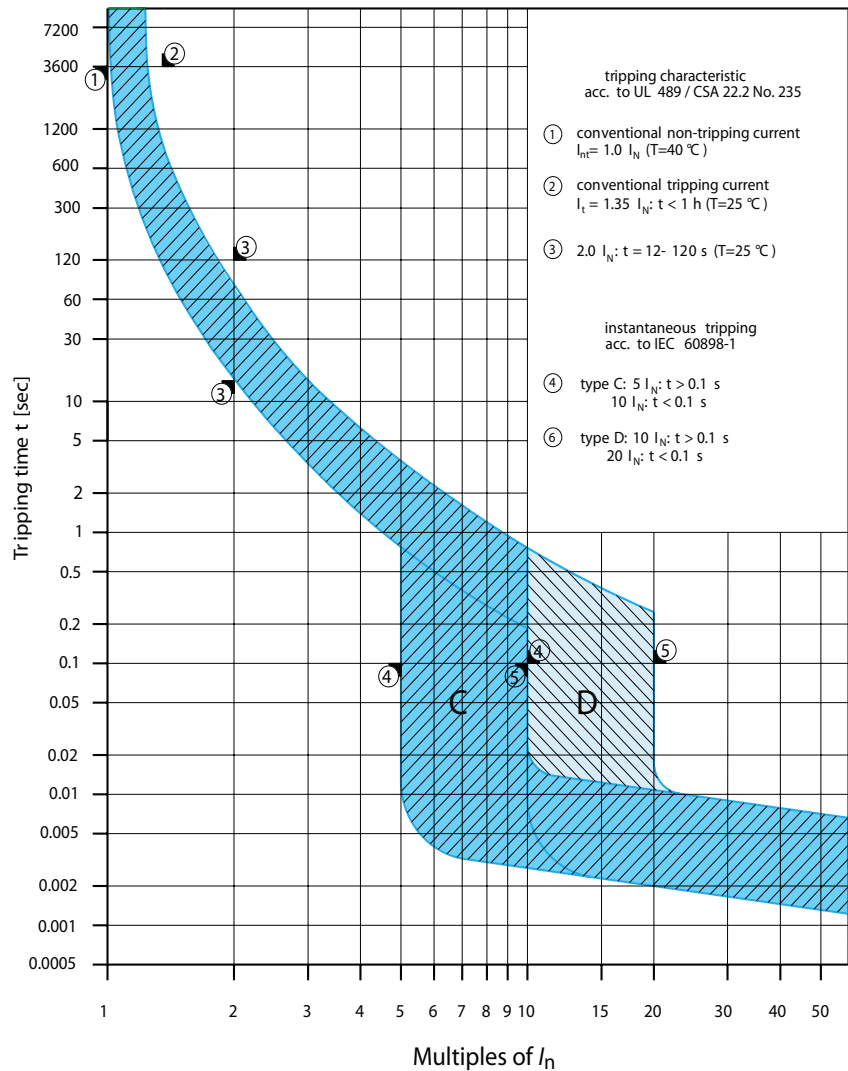

## WMZT Miniature Circuit Breakers Dimensions

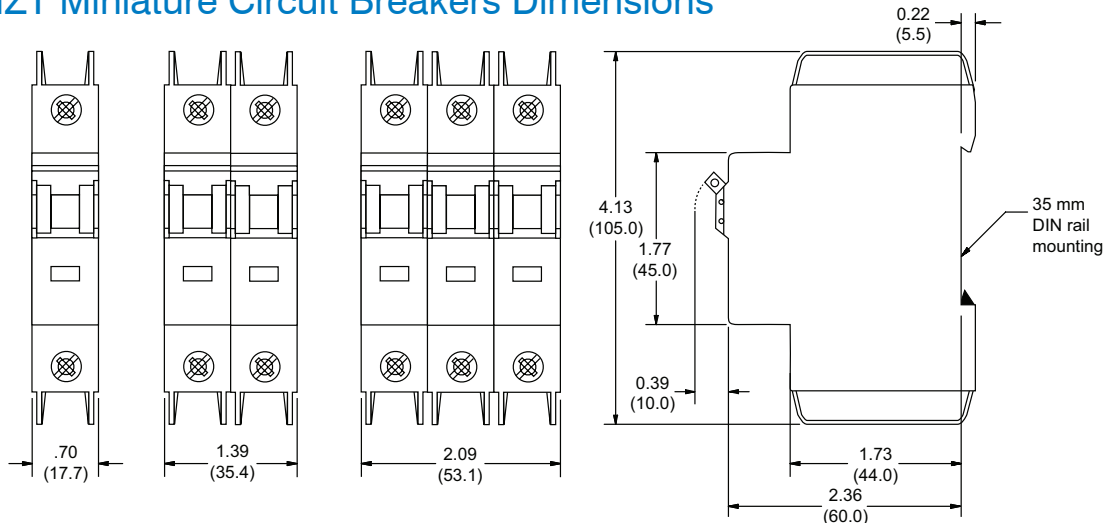

Dimensions are approximate, inches (mm) - Not for construction purposes

# EATON WMZT Series Technical Data

Influence of Ambient Temperature T on Load Carrying Capacity								
Device Market Current Rating $I_n$ (A) at 40°C	$I_n$ (A) at Higher Ambient Temperature							
	15°C	20°C	25°C	30°C	40°C	50°C	55°C	60°C
0.5	0.6	0.5	0.5	0.5	0.5	0.5	0.5	0.5
1.0	1.1	1.1	1.1	1.0	1.0	1.0	0.9	0.9
1.5	1.7	1.6	1.6	1.6	1.5	1.4	1.4	1.4
2.0	2.2	2.2	2.1	2.1	2.0	1.9	1.9	1.8
3.0	3.3	3.2	3.2	3.1	3.0	2.9	2.9	2.8
4.0	4.4	4.3	4.2	4.2	4.0	3.8	3.8	3.7
5.0	5.5	5.4	5.3	5.2	5.0	4.8	4.7	4.6
6.0	6.6	6.5	6.4	6.2	6.0	5.8	5.6	5.5
7.0	7.7	7.6	7.4	7.3	7.0	6.7	6.6	6.4
8.0	8.8	8.6	8.5	8.3	8.0	7.7	7.5	7.4
10.0	11.0	10.8	10.6	10.4	10.0	9.6	9.4	9.2
13.0	14.3	14.0	13.8	13.5	13.0	12.5	12.5	12.0
15.0	16.5	16.2	15.9	15.6	15.0	14.4	14.1	13.8
16.0	17.6	17.3	17.0	16.6	16.0	15.4	15.0	14.7
20.0	22.0	21.6	21.2	20.8	20.0	19.2	18.8	18.4
25.0	27.5	27.0	26.5	26.0	25.0	24.0	23.3	23.0
30.0	33.0	32.4	31.8	31.2	30.0	28.8	28.2	27.6
32.0	35.2	34.6	33.9	33.3	32.0	30.7	30.1	29.4
40.0	44.0	43.2	42.4	41.6	40.0	38.4	37.6	36.8

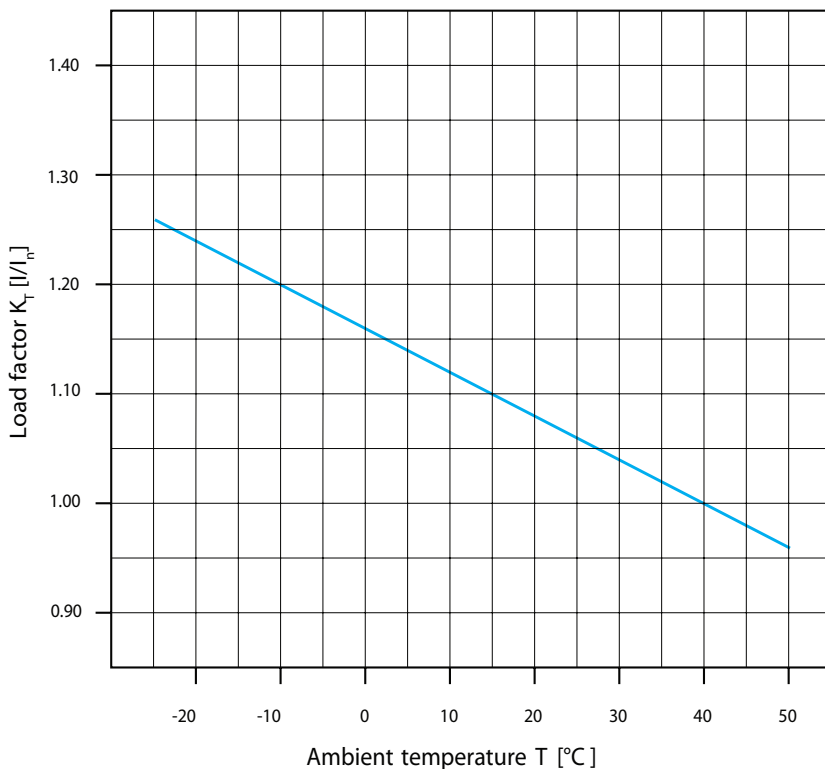

Maximum load  $I_L$  at ambient temperature T:  
 $I_L(T) = I_n K_T(T)$

- $I_L$  = Maximum Load
- T = Ambient Temperature
- $I_n$  = Rated Current in Amps
- $K_T$  = Load Factor

# EAT-N WMZT Series Accessories

## Field Mountable Accessories

- Auxiliary switch
- Alarm switch
- Shunt trip
- No tools required for mounting



**WMZTAUX**  
Auxiliary Contact



**WMZSAUXTRIP**  
Alarm/Aux Contact



**WMZTSTxxx**  
Shunt Trip

WMZT Accessories Selection Guide					
Part Number	Description	Contacts	Module Width	Module Weight	Price
<b>WMZTAUX</b>	<ul style="list-style-type: none"> <li>• 1 NO / 1 NC Contact</li> <li>• Installs on left side of WMZT or Shunt Trip</li> <li>• Maximum one per WMZT (489) Device</li> <li>• Switches when WMZT is tripped electrically or manually</li> </ul>	1 NO / 1 NC	0.35" (8.9 mm)	0.15 lb (68g)	\$16.00
<b>WMZSAUXTRIP</b>	<ul style="list-style-type: none"> <li>• Two Form C (One set Changeover) contacts, 1 SPDT aux / 1 SPDT alarm</li> <li>• Small selector screw changes mode</li> <li>• Installs on left side of WMZS, WMZT or shunt trip</li> <li>• Auxiliary contacts switch when WMZS or WMZT is tripped electrically or manually.</li> <li>• Trip indicating contact switches only when WMZS or WMZT is tripped electrically.</li> </ul>	(2) Form C			\$20.00
Part Number	Description	Trip Voltage	Module Width	Module Weight	Price
<b>WMZTST415</b>	<ul style="list-style-type: none"> <li>• Allows remote trip of WMZT</li> <li>• Installs on left side of WMZT</li> </ul>	110 - 415 VAC 110 - 230 VDC	0.69" (17.5 mm)	0.28 lb (127g)	\$28.50
<b>WMZTST110</b>		12 - 110 VAC 12 - 60 VDC			\$28.50

WMZT Accessory Data						
Part Number	Circuit Diagram	Electrical Characteristics	Wire Size (Solid and Stranded)		Terminal Tightening Torque	
			mm <sup>2</sup>	AWG	N·m	lb·in
<b>WMZTAUX</b>		Rated for general use, 2A at 230 VAC / 0.5 A at 24/110 VDC 50 / 60 Hz	(1) 0.5 to 2.5 (2) 0.5 to 2.5 (2) 2.5	(1) 20 to 14 (2) 18 to 14 (2) 14	1.2	10.6
<b>WMZSAUXTRIP</b>	See WMZSAUXTRIP diagrams on next page	1 SPDT auxiliary contact and 1 SPDT alarm contact that can be configured and used as an auxiliary contact, rated for general use, 2A at 200 VAC / 0.5 A at 24/110 VDC 50 / 60 Hz	(1) 0.5 to 2.5 (2) 0.5 to 1.5 (2) 1.5	(1) 18 to 14 (2) 18 to 16 (2) 16	0.8	7.0
<b>WMZTST415</b>		110 - 415 VAC, 110 - 230 VDC operating range 0.5 A at 110 VAC, 2A at 415 VAC 0.5 A at 110 VDC, 1.1 A at 230 VAC	(1) 1 to 6 (2) 1 to 6 (2) 6	(1) 18 to 10 (2) 18 to 10 (2) 10	2.8	25.0
<b>WMZTST110</b>		12 - 110 VAC, 12 - 60 VDC operating range 0.5 A at 12 VAC, 4.4 A at 110 VAC 0.5 A at 12 VDC, 2.4 A at 60 VDC				

## Allowable Combinations of Accessories

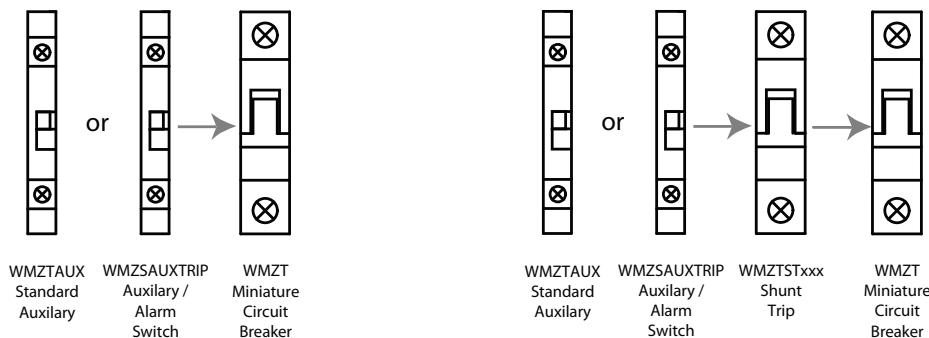



# EATON WMZT Series Accessories

## Accessories Dimensions

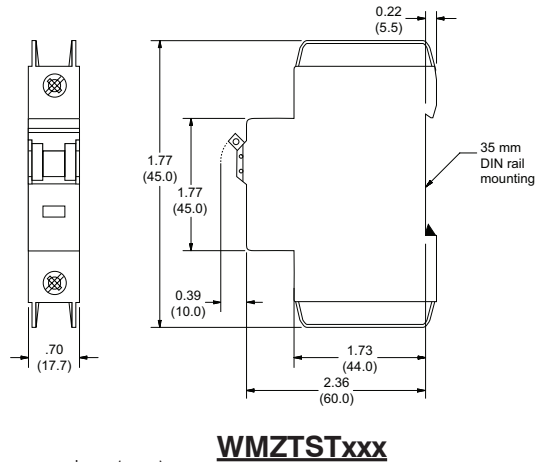
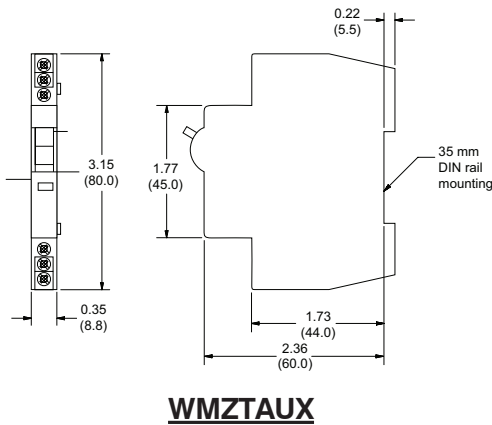
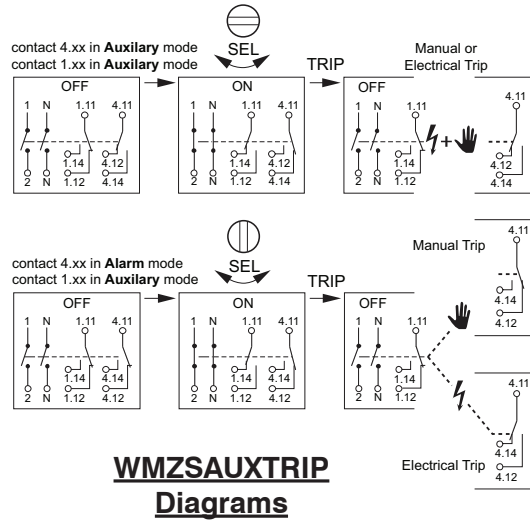
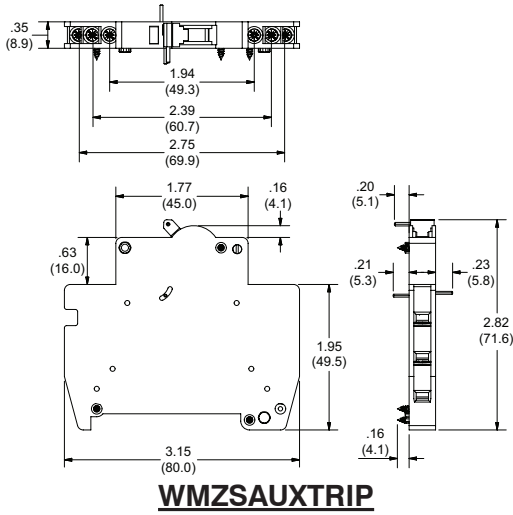

Dimensions are approximate, inches (mm) - Not for construction purposes

## Lockout Attachment



**WMZPLK**

**Lockout Attachment**

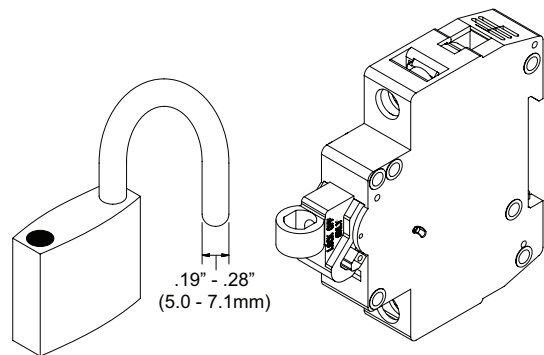

Additional WMZT Accessories			
Part Number	Description	Weight	Price
<b>WMZPLK</b>	Lockout attachment for Eaton WMZS series supplementary protectors and WMZT mini circuit breakers, suitable to prevent unauthorized activation of a de-energized circuit, accepts lock shackles up to 9/32 in. (7.1 mm) in diameter Qty: 5 pieces	0.10 lb (45g)	\$30.50

# EATON WMZT Series Accessories

## Bus Bar System

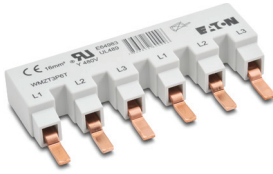

**WMZTxP6TSP**  
WMZT Bus Bar

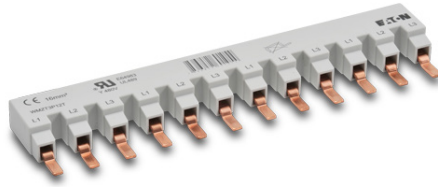

**WMZTxP12TSP**  
WMZT Bus Bar

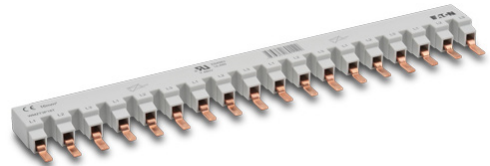

**WMZTxP18TSP**  
WMZT Bus Bar

WMZT Bus Bar		
Part Number	Description	Price
WMZT1P6TSP	Bus Bar for connecting up to six (6) 1-pole WMZT series circuit breakers	\$8.50
WMZT1P12TSP	Bus Bar for connecting up to twelve (12) 1-pole WMZT series circuit breakers	\$15.50
WMZT1P18TSP	Bus Bar for connecting up to Eighteen (18) 1-pole WMZT series circuit breakers	\$23.00
WMZT2P6TSP	Bus Bar for connecting up to three (3) 2-pole WMZT series circuit breakers	\$9.50
WMZT2P12TSP	Bus Bar for connecting up to six (6) 2-pole WMZT series circuit breakers	\$19.00
WMZT2P18TSP	Bus Bar for connecting up to nine (9) 2-pole WMZT series circuit breakers	\$28.00
WMZT3P6TSP	Bus Bar for connecting up to two (2) 3-pole WMZT series circuit breakers	\$10.00
WMZT3P12TSP	Bus Bar for connecting up to four (4) 3-pole WMZT series circuit breakers	\$20.00
WMZT3P18TSP	Bus Bar for connecting up to six (6) 3-pole WMZT series circuit breakers	\$29.50

*Note: WMZT Bus Bar is not for use with WMZS supplementary protectors.*

Bus Bar Specifications			
Description	UL489		IEC/EN60947-2
Operating Voltage	480VAC	96VDC	240 / 415 VAC
Frequency	50 / 60Hz	n/a	50 / 60Hz
Rated impulse withstand - $U_{imp}$	n/a		9.5 kV
Max Current - $I_e$	80A @ 40°C		80A @ 30°C
Cross Section	n/a		16 mm <sup>2</sup>

### Dimensions

Dimensions are approximate, inches (mm) - Not for construction purposes

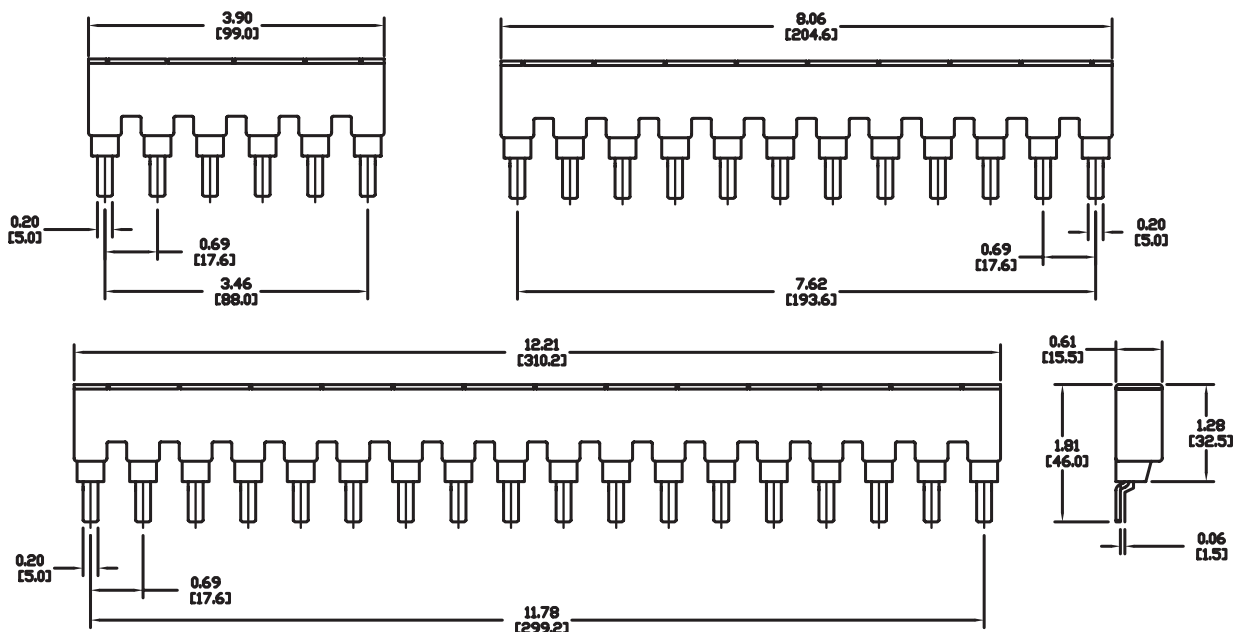

# EATON WMZT Series Accessories

## Bus Bar Accessories



**WMZT3PSHROUD**  
Bus Bar Shroud



**WMZT35EXT**  
Wiring Lug

WMZT Bus Bar Accessories		
Part Number	Description	Price
WMZT3PSHROUD	Bus Bar Shroud - covers for unused bus bar terminals, (10) 3-terminal covers per package	\$22.00
WMZT35EXT	Wiring Lug, 35mm (2 - 14 AWG), 3 lugs per package	\$26.00

WMZT35EXT - Specifications		
Description	UL489	IEC/EN60947-2
Operating Voltage	480VAC	96VDC
		240 / 415 VAC
Frequency	50 / 60Hz	n/a
Rated impulse withstand - $U_{imp}$	n/a	
Max Current - $I_e$	80A @ 40°C	80A @ 30°C
	#2 - 14 AWG	2.5 - 35 mm <sup>2</sup>
	0.56 in	14mm

WMZT35EXT - Tightening Torque		
Tested Acc. To	Cable Size	Tightening Torque
UL 486A	#14 AWG	≥ 2.3 N·m (20 lb·in)
UL 486B	#8 - 12 AWG	≥ 2.8 N·m (25 lb·in)
UL 486E	#6 - 1 AWG	4 N·m (35 lb·in)

## Dimensions

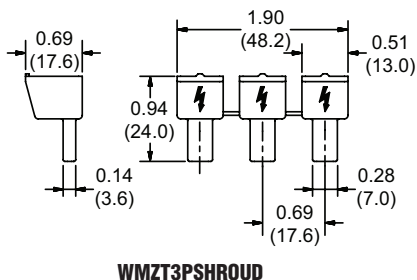

**WMZT3PSHROUD**

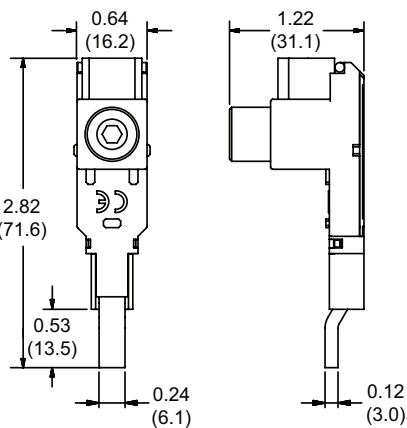

**WMZT35EXT**

Dimensions are approximate, inches (mm) - Not for construction purposes

