

# Wiring Devices – NEMA Wiring Diagrams

Reference material only. Please see Wiring Section in the catalog for product part number.

## 2-Pole 2-Wire

125V

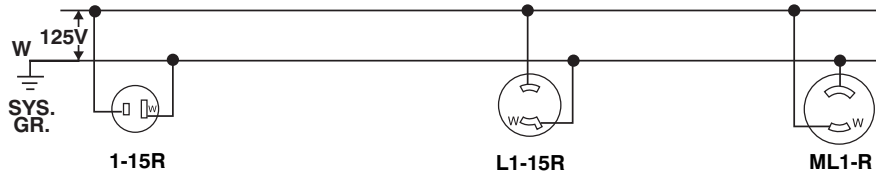

208V or 250V

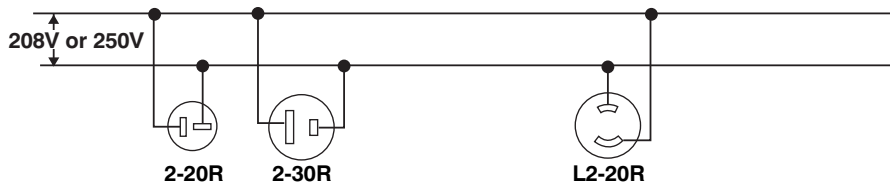

## 2-Pole 3-Wire Grounding

125V

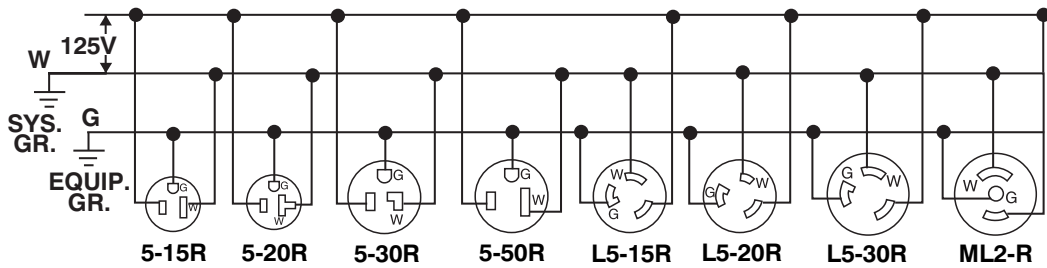

208V or 250V

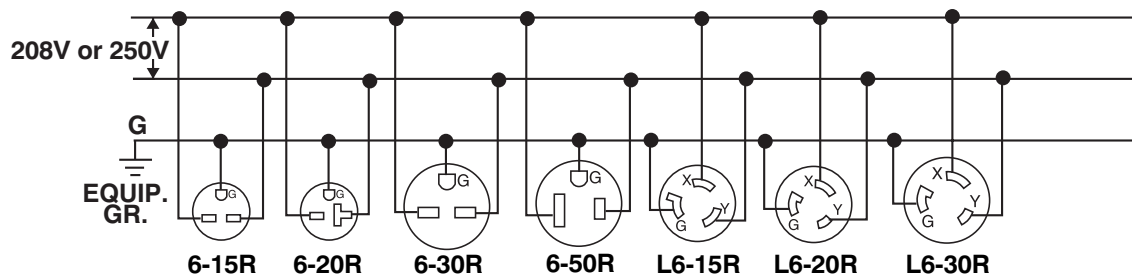

277V AC

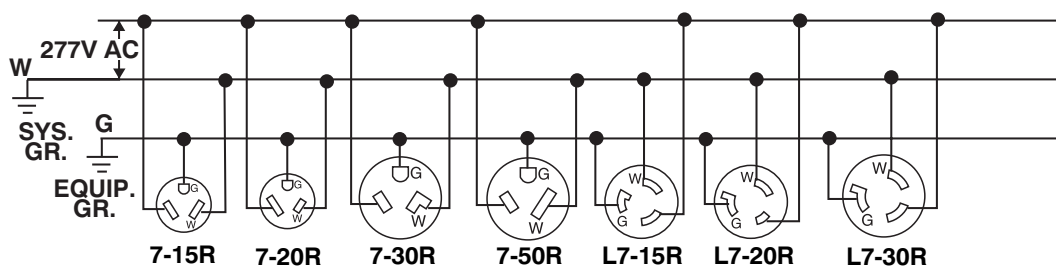

# Wiring Devices – NEMA Wiring Diagrams

## 2-Pole 3-Wire Grounding

### 480V AC

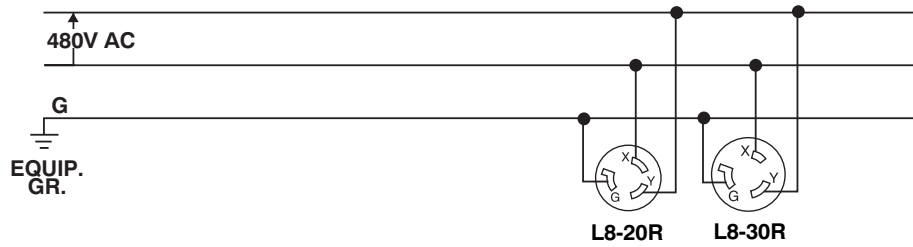

### 600V AC

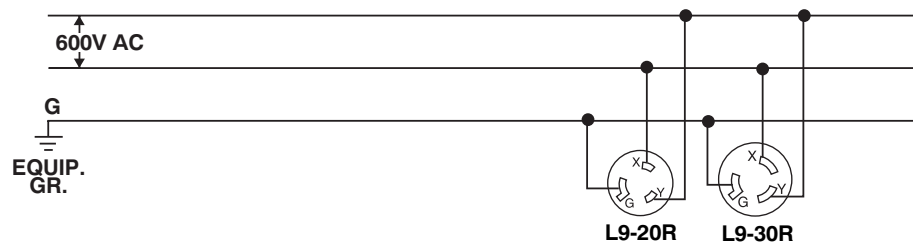

## 3-Pole 3-Wire

### 125V/250V AC

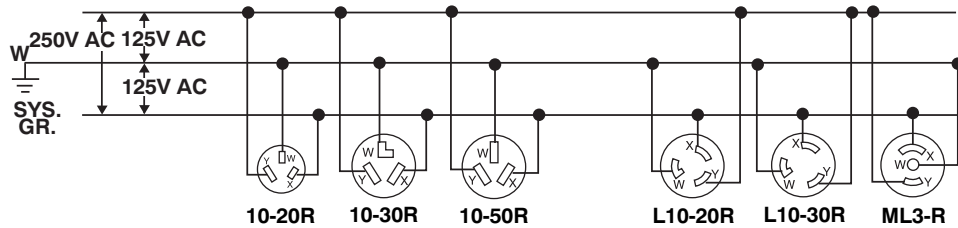

### 3Ø 250V AC

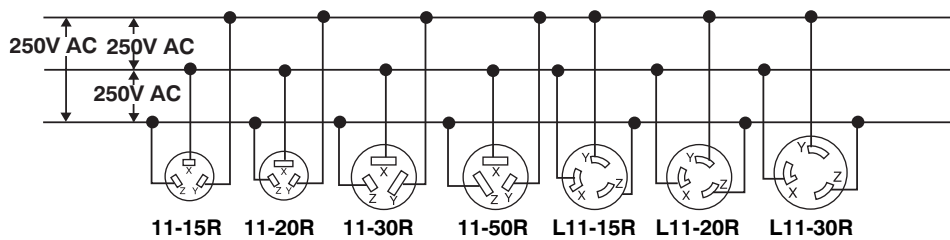

### 3Ø 480V AC

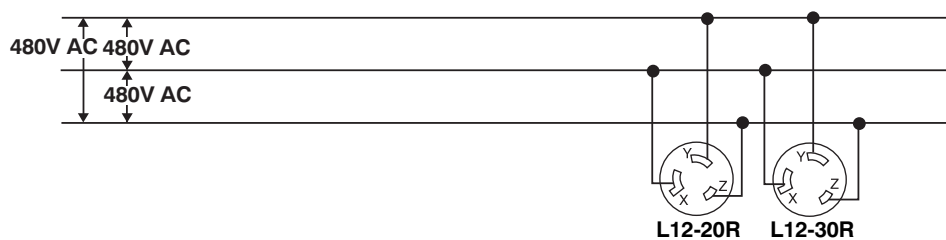

# Wiring Devices – NEMA Wiring Diagrams

## 3-Pole 3-Wire Continued

**3 $\phi$  600V AC**

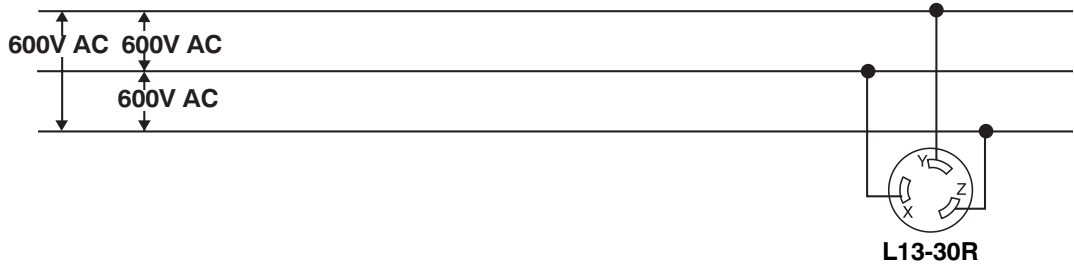

## 3-Pole 4-Wire Grounding

**125/250V AC**

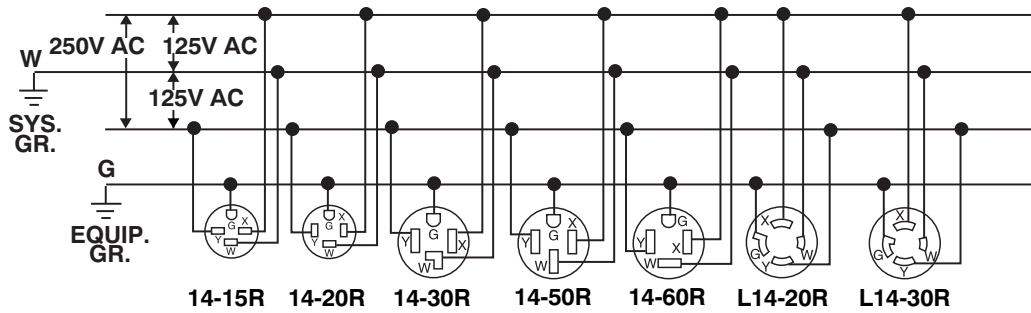

**3 $\phi$  250V AC**

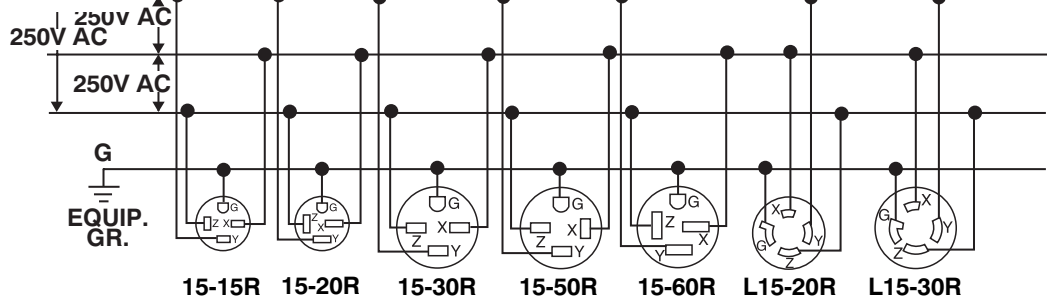

**3 $\phi$  480V AC**

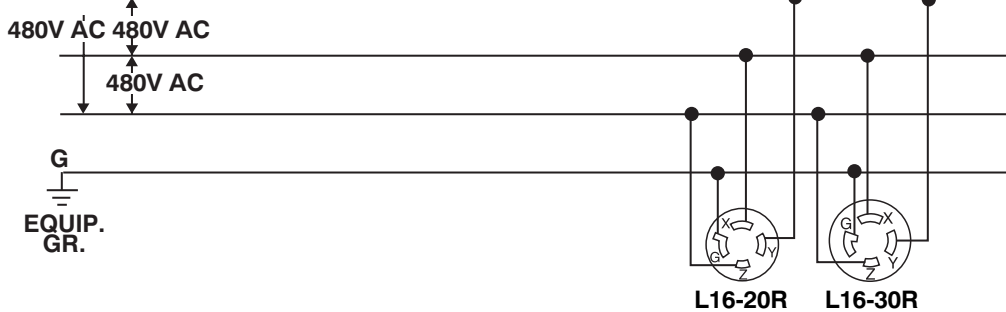

# Wiring Devices – NEMA Wiring Diagrams

## 3-Pole 4-Wire Grounding Continued

### 3 $\phi$ 600V AC

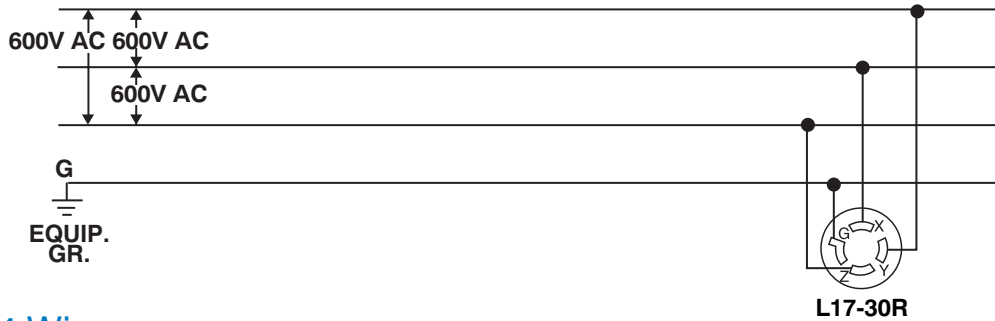

## 4-Pole 4-Wire

### 3 $\phi$ Y 120/208V AC

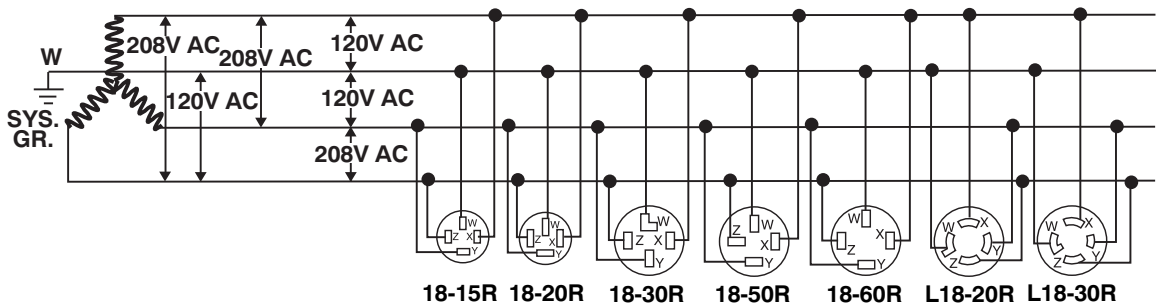

### 3 $\phi$ Y 277/480V AC

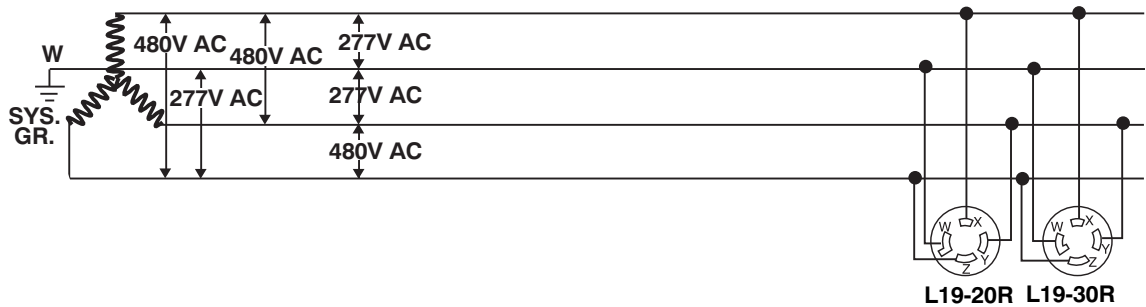

### 3 $\phi$ Y 347/600V AC

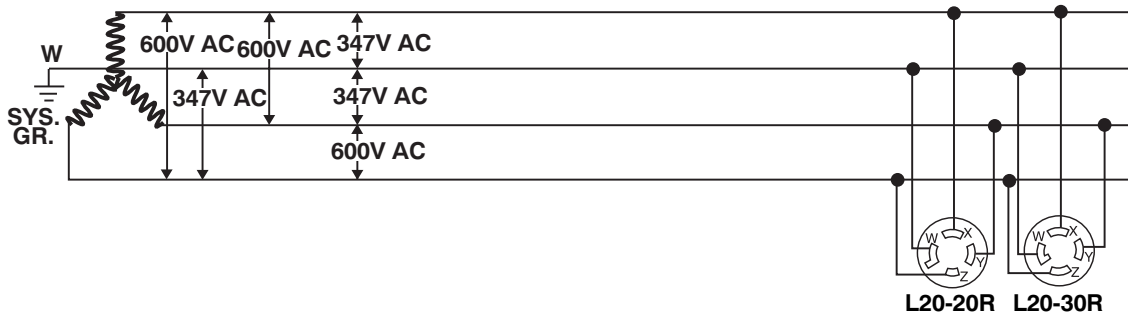

# Wiring Devices – NEMA Wiring Diagrams

## 4-Pole 5-Wire Grounding

**3 $\phi$ Y 120/208V AC**

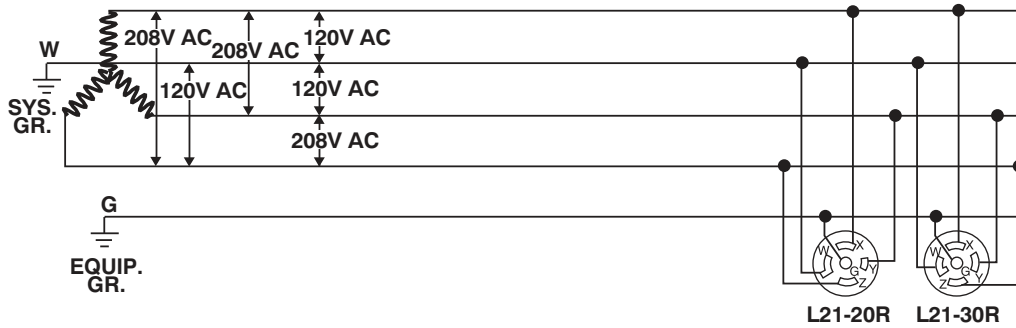

**3 $\phi$ Y 277/480V AC**

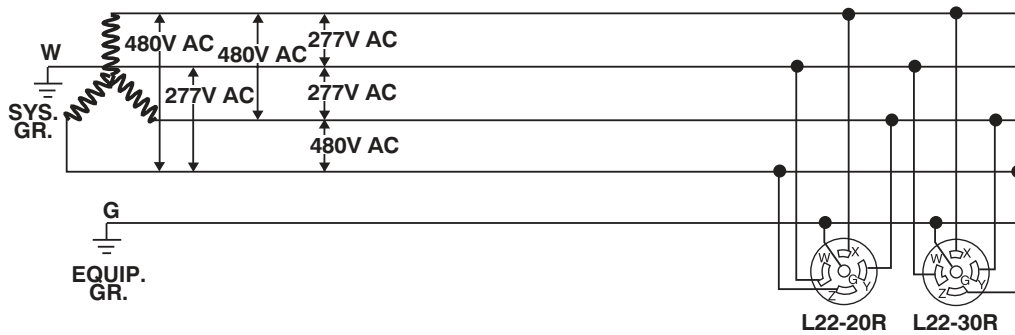

**3 $\phi$ Y 347/600V AC**

