



EchoPod® & EchoSonic® II Ultrasonic Liquid Level Sensors



The EchoPod and EchoSonic II are innovative ultrasonic liquid level sensor families that replace float, conductance and pressure sensors that fail due to contact with dirty, sticky and scaling media in small, medium and large capacity tanks. Applied in chemical, water and wastewater applications, these general purpose non-contact sensors are available with single and multi-function capabilities including continuous level measurement, switching and control.

For input to a PLC or other controller, measurement outputs include current, voltage and frequency. Models with four relays can be configured for level alarms and/or stand-alone level control such as automatic fill or empty functions using the embedded level controller. PC configuration is simple with **WEBCAL™** software.



EchoPod & EchoSonic II Ultrasonic Liquid Level Sensors General Specifications										
Model	DL34-00	DL24-00	DL14-00	DS14-00	DX10-00	DL10-00	LU27-00	LU23-00	LU28-00	LU29-00
Price	\$800.00	\$600.00	\$450.00	\$485.00	\$400.00	\$400.00	\$750.00	\$800.00	\$995.00	\$1,145.00
Type	EchoPod					EchoSonic II				
Class	General Purpose (non-hazardous)									
Media*	Liquids									
Range	8in to 18 ft (20cm to 5.5 m)	4in to 9.8 ft (10cm to 3m)	2in to 4.1 ft (5cm to 1.25 m)			4in to 9.8 ft (10cm to 3m)	8in to 18 ft (20cm to 5.5 m)	8in to 26.2 ft (20cm to 8m)	8in to 32.8 ft (20cm to 10m)	
Output Types	4-20 mA and (4) SPST relays			(4) SPST relays	0-5V, 0-10V, 976-2000 Hz	4-20 mA				
Install	Vertical, top of tank									
Mounting	2in MNPT	1in MNPT				2in MNPT				
Relays	(4) SPST				No Relay					
Configuration	WEBCAL Software (free download) and LI99-2001 Fob USB Adapter (purchased separately)									
Ambient Temperature	-31° to 140°F (-35° to 60°C)									
Process Temperature	20° to 140°F (-7° to 60°C)					-4° to 140°F (-20° to 60°C)				
Pressure	30 PSI (2 bar) max.									

* Any factor that negatively affect sound's ability to travel such as, vapor, condensation, foam, turbulence, vacuum, etc., will have a negative effect on the ultrasonic sensor signal and should be avoided. For condensing environments the Flowline UG/US series of Reflective Ultrasonic Level Sensors are recommended.

WEBCAL Software



[WEBCAL](#)



[LI99-2001](#)

WEBCAL PC software is a utility program that allows users to easily configure their EchoSonic II and EchoPod level transmitters, switches, and controllers. Download your free copy of [WEBCAL](#) at www.AutomationDirect.com, and connect your sensor through our Fob USB adapter (LI99-2001). Develop your configuration using pre-programmed function menus as the tank graphic and set point fields automatically change to match your configuration. Then, input your level set point values and click the Write to Unit button. Your configuration will be downloaded into the sensor and verified in less than a second. Last, click the Wiring Diagram button to open a wiring schematic of your configuration in PDF format. Print the document, disconnect the sensor and wire it per the schematic. As new software or firmware becomes available, they can be downloaded and updated through [WEBCAL](#).



Click on the thumbnail or go to <https://www.automationdirect.com/VID-LE-0003> for a short video introduction to Flowline Ultrasonic Level Switches.



Click on the thumbnail or go to <https://www.automationdirect.com/VID-LE-0002> for a short video introduction to Flowline EchoTouch, EchoSpan, EchoSwitch and PodView product lines.



[LI40-1001](#)

PodView®

The PodView digital level indicator is a low cost general purpose level indicator that displays engineering units for level or volume and shares power with an EchoPod ultrasonic sensor, including loop powered devices. The LI40 can be field mounted for local indication as well as be used to make simple setting changes to the sensor. The display can be easily attached to any EchoPod sensor that has been configured with [WEBCAL](#) 6.0 / firmware 50.0 or higher. PodView displays sensor output and can reconfigure sensor setpoints on the fly. PodView shares power with the sensor and does not require any additional outside power supply.



EchoPod DL10 Ultrasonic Liquid Level Transmitter



Overview

The EchoPod DL10 ultrasonic liquid level transmitter provides continuous level measurement up to 4.1 ft (1.25m), with a 4-20mA signal output, and is configured via [WEBCAL](#) software. This non-contact liquid level sensor is ideally suited for corrosive, sticky or dirty liquids, and is broadly selected for small day tank, skid, intermediate bulk tanks, sump and process tank level applications.

Features

- Continuous non-contact level measurement output up to 4.1 ft (1.25 m)
- 4-20 mA output for longer signal distances, up to 1000 ft. (300m)
- Configuration is fast and easy via [WEBCAL](#) software and USB adapter
- Narrow 2 inch beam width and short 2 inch dead band optimized for small tanks
- PVDF transducer and NEMA Type 6P polycarbonate enclosure for corrosive liquids, UV stable for outdoor use
- Automatic temperature compensation for accurate measurement
- 2-year warranty

Agency Approvals

- cFMus



Dimensions

inches [mm]

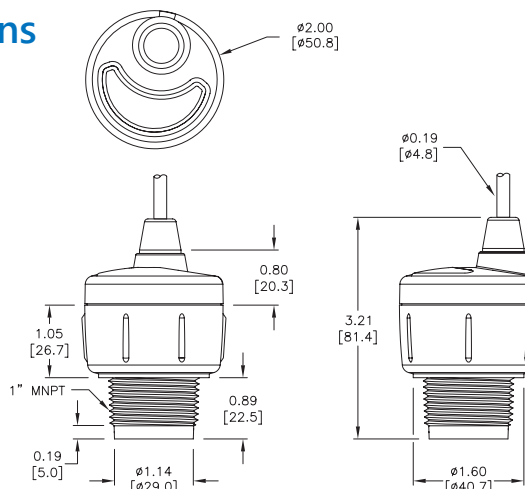

See our website www.AutomationDirect.com for complete Engineering drawings.

Configuration

The settings for the the DL10 are configured with free [WEBCAL](#) software (downloadable from AutomationDirect Web site) and an [LI99-2001](#) Fob USB adapter (purchased separately).

Wiring

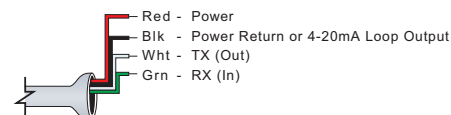

Maximum Loop Resistance in Ω

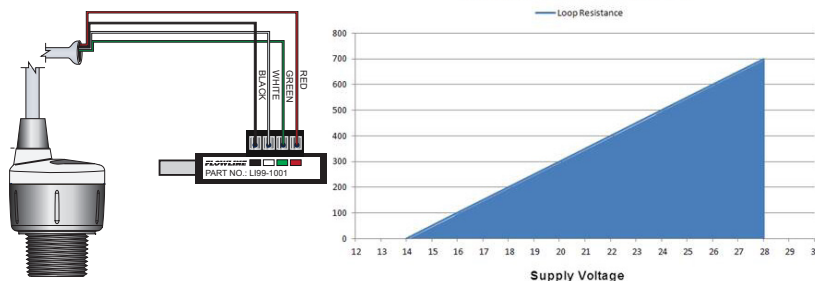

DL10-00 Technical Specifications	
Price	\$400.00
Range	2in to 4.1 ft (5cm to 1.25 m)
Accuracy	0.125 in (3mm)
Resolution	0.019 in (0.5 mm)
Sensing Dead Band*	2in (5cm)
Beam Width	2in (5cm)
Configuration	WEBCAL Free Software and LI99-2001 Fob USB Adapter
Memory	Non-volatile
Loop Supply Voltage	14-28 VDC ¹
Consumption	0.5 W
Loop Resistance	500 Ω max at 24 VDC
Signal Output	4-20 mA, two-wire
Signal Invert	4-20 mA or 20-4 mA
Signal Fail-Safe	4mA, 20mA, 21mA, 22mA or hold last
Process Temperature	20° to 140°F (-7° to 60°C)
Temp. Compensation	Automatic
Ambient Temperature	-31° to 140°F (-35° to 60°C)
Pressure	30 PSI (2 bar) MAX
Enclosure Rating	NEMA Type 6P, IP67, encapsulated, corrosion resistant & submersible, UV stable
Enclosure Material	Polycarbonate
Strain Relief Material	Santoprene
Transducer Material	Polyvinylidene Fluoride
Cable Jacket Material	Polyurethane
Cable Type	4-conductor, shielded
Cable Length	48in (1.2 m)
Process Mount	1in MNPT (See accessories for installation fittings)
Mount Gasket	Viton (included, replacement part number 204038)
Weight (lbs)	0.5
Classification	General purpose
Compliance	CE, RoHS
Agency Approvals	cFMus

* Dead band is the minimum distance the sensor must be mounted above the max liquid level.

¹ If supply exceeds 28 VDC damage to the transmitter may occur.

When installing the 1 inch NPT level sensors care should be used to mechanically isolate the sensor housing from the tank. This can easily be done by using any of the Flowline mounting accessories which are designed to provide the isolation needed. See the end of the Ultrasonic Level Sensor Section for further details and Accessories



PodView® Digital Level Indicator



Overview

The PodView digital level indicator is a low cost general purpose indicator that displays engineering units for level or volume when combined with an EchoPod DL, DS and DX series ultrasonic sensor that has been configured with [WEBCAL 6.0 / firmware 50.0](#) or higher. The LI40 can be field mounted for local indication as well as be used to make simple setting changes to the sensor. PodView displays sensor output and can reconfigure sensor set points on the fly without needing to connect to a PC. PodView shares power with the EchoPod DL, DS and DX series sensor and does not require any additional separate power supply.

Features

- Operates with all EchoPod DL, DS and DX series level sensors compatible with [WEBCAL 6.0](#) software / firmware 50.0 or higher
- No separate power supply required
- Use PodView to make simple adjustments to EchoPods sensor settings
- Provides level indication up to 15 feet from sensor
- Corrosion resistant NEMA 4 / IP65 enclosure
- No configuration required for the display. Simply wire the display directly to a programmed compatible EchoPod sensor
- Display can be transferred from sensor to sensor without any configuration changes to the display
- Make quick setpoint changes without the need to connect sensor back to a PC
- 2-year warranty

Agency Approvals

- CE



LI40-1001 Technical Specifications	
Price	\$275.00
Display Type	LCD, 6-digit with 4 relay indicators
Display (Engineering Units)	Level or Volume
Character Height	0.374 in (9.5 mm)
Linearization	per sensor configuration
User Interface	Three button
Input	EchoPod DL, DS and DX sensor family
Memory	Non-volatile
Supply Voltage	12-28 VDC power shared with sensor (EchoPod not to exceed 28 VDC)
Operating Temperature	-4°F to 140°F (-20°C to 60°C)
Cable Type	4-conductor, 22 AWG (0.33 mm ²)
Cable Length	4ft (1.2 m)*
Cable Jack Material	Polyurethane
Enclosure Rating	NEMA 4 (IP65) faceplate
Enclosure Material	Polycarbonate
Enclosure Mount	Panel
Button Material	Silicon rubber
Classification	General purpose
Weight (lbs)	0.6
Compliance	CE, RoHS

* Maximum distance between EchoPod sensor and PodView display is 15 ft (4.5m)

Dimensions inches [mm]

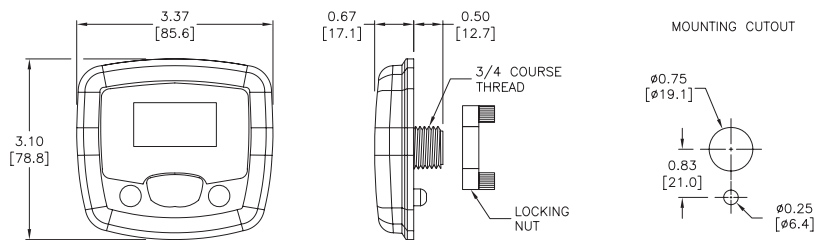

See our website www.AutomationDirect.com for complete Engineering drawings.

Configuration

The settings for the the EchoPod DL, DS and DX series are configured with free [WEBCAL](#) software (downloadable from AutomationDirect Web site) and an [LI99-2001](#) Fob USB adapter (purchased separately). To be compatible with PodView the EchoPod DL, DS and DX sensor must be configured with WebCal 6.0 / firmware 50.0 or higher.

Wiring

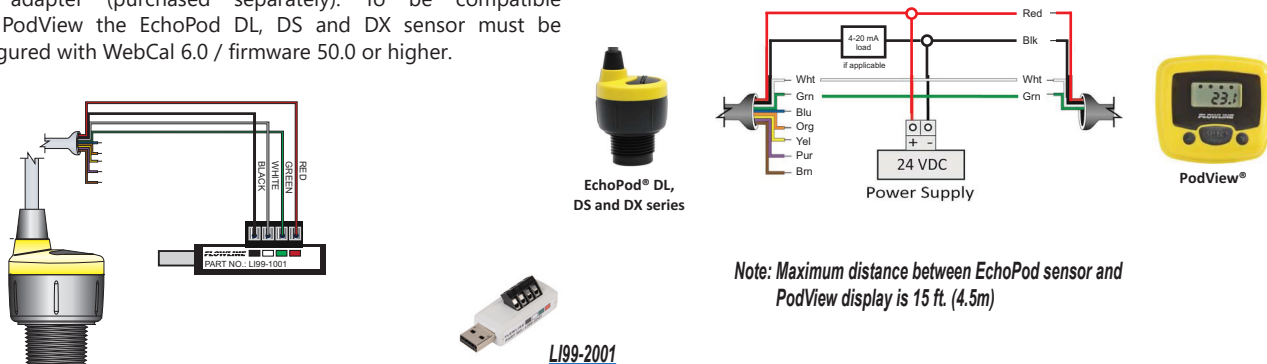

Note: Maximum distance between EchoPod sensor and PodView display is 15 ft. (4.5m)

See the [WEBCAL](#) software catalog page in this section for further details



WebCal Ultrasonic Level Sensor Software and USB Fob Adapter



Overview

WEBCAL PC software is a utility program that allows users to easily configure their EchoPod, EchoTouch and EchoSonic II level transmitters, switches, and controllers. Download your free copy of **WEBCAL** at www.AutomationDirect.com, and connect your sensor through the Fob USB adapter ([LI99-2001](#)). Develop your configuration using pre-programmed function menus as the tank graphic and set point fields automatically change to match your configuration. Then, input your level set point values and click the Write to Unit button. Your configuration will be downloaded into the sensor and verified in less than a second. Last, click the Wiring Diagram button to open a wiring schematic of your configuration in PDF format. Print the document, disconnect the sensor and wire it per the schematic. It's that simple.

Configuration files can be named, saved, emailed, printed, opened and used again under revision control. The advanced feature page enables you to change the measurement signal, output filtering and invert relay states from N.O. to N.C. As new software or firmware becomes available, they can be downloaded and updated through **WEBCAL**.

Features

- 169 configurations with pull-down menu selections
- Graphical interface lets you visualize your configuration
- Applicable level set point fields appear automatically
- Installs and tests configuration in less than a second
- Available PDF wiring diagram for each configuration
- Technical help menu with FAQs, tips and glossary
- Rapidly program sensors to the same configuration
- Save configuration files for future use or reference
- Print wiring diagrams and configuration text files
- Email configuration files to other remote users
- Please check www.automationdirect.com for the most recent system requirements.

WebCal Ultrasonic Level Sensor Software and USB Adapter					
Part No.	Item Photo	Description	Quantity	Weight (lbs)	Price
LI99-2001		Flowline Fob USB adapter, required for use with WebCal software to configure Flowline EchoPod, EchoTouch and EchoSonic II ultrasonic level sensors.	1	0.1	\$65.00
WEBCAL		Configuration software for Flowline EchoPod, EchoTouch and EchoSonic II ultrasonic level sensors. Requires an LI99-2001 Fob USB adapter (purchased separately).	1	0.1	Free Download

EchoPod Configuration

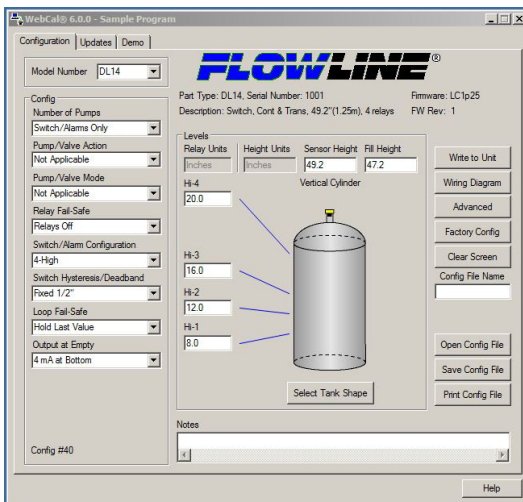

EchoSonic II Configuration

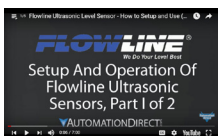
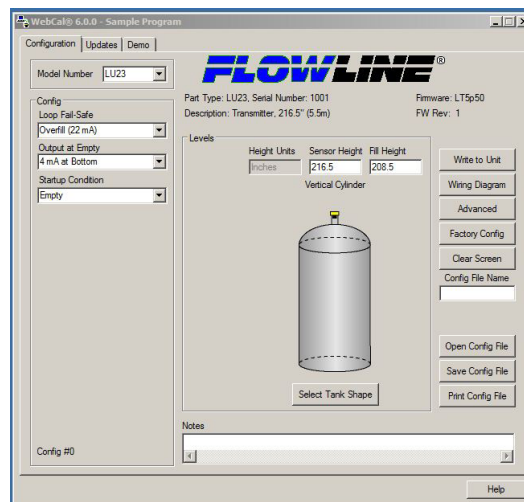

Click on the thumbnail or go to <https://www.automationdirect.com/VID-LE-0004> for Part 1 of our How To video on the use of the Flowline Ultrasonic Level Sensors



Click on the thumbnail or go to <https://www.automationdirect.com/VID-LE-0005> for Part 2 of our How To video on the use of the Flowline Ultrasonic Level Sensors