

SJ300 Accessories — Filters

Pulse width modulation filter

Application

The Pulse Width Modulation filter card smooths the pulse-width modulated signal from the FM output terminal on the drive to a 0-10 VDC signal. This signal can then be used as a source to PLC analog input modules or metering devices. The FA-4PWM has four channels for use with multiple inverters.



FA-4PWM shown connected between an SJ300 drive and channel 1 of an F2-04AD-2 analog input module.

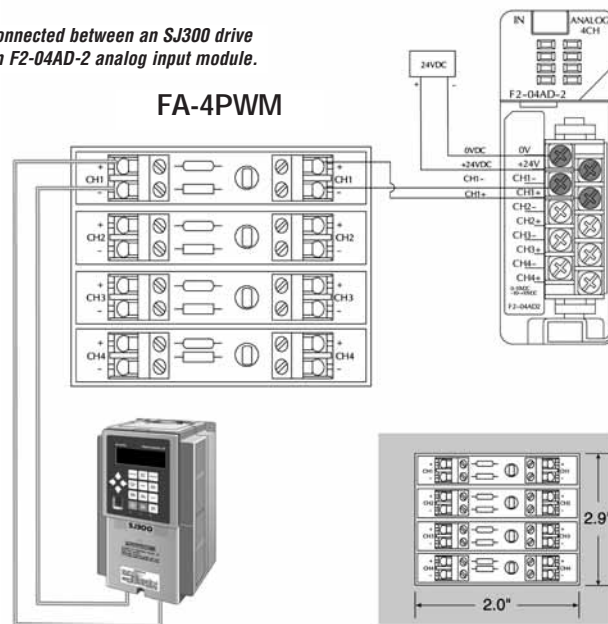

Pulse Width Modulation Filter	
Part Number	Price
FA-4PWM	<--->

RF capacitive filters

Application

The RF filters can be used on the input side of the inverter to reduce RF noise.

Specifications			
Part #	Input Voltage	Ambient Temperature	Price
CFI-L	230V, 50/60 Hz	-40 to 85°C (-99 to 185°F)	<--->
CFI-H	460V, 50/60Hz		<--->

CFI-L dimensions

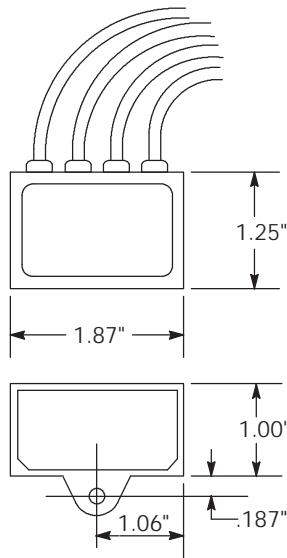

CFI-H dimensions

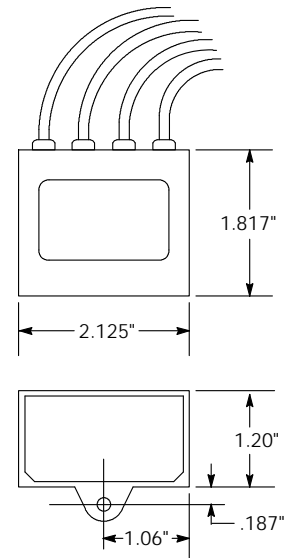

- PLC Overview
- DL05/06 PLC
- DL105 PLC
- DL205 PLC
- DL305 PLC
- DL405 PLC
- Field I/O
- Software
- C-more HMIs
- Other HMI
- AC Drives**
- Motors
- Steppers/Servos
- Motor Controls
- Proximity Sensors
- Photo Sensors
- Limit Switches
- Encoders
- Current Sensors
- Pushbuttons/Lights
- Process
- Relays/Timers
- Comm.
- TB's & Wiring
- Power
- Circuit Protection
- Enclosures
- Appendix
- Part Index

SJ300 Accessories — EMI Filters

EMI filters

EMI filters reduce electromagnetic interference, or noise, on the input side of the inverter. EMI filters are needed for CE compliance.

NF-CEH7 to NF-CEH40 dimensions

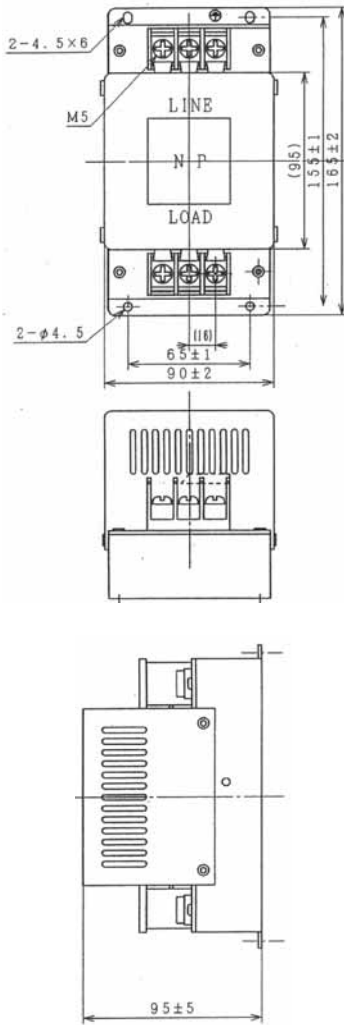

Filter dimensions are in mm.
(1 inch = 25.4 mm)
Example: 40 mm to inches-40/25.4 = 1.57 in.

SJ300 Model EMI Filter				
200V Class	400V Class	EMI Filter	EMI Filter Rating	Price
004LFU	007HFU	NF-CEH7	1/2 - 1Hp 230VAC and 1 - 3Hp 480VAC	<--->
007LFU	015HFU			
	022HFU			
015LFU	040HFU	NF-CEH10	NF-CEH10 2Hp 230VAC and 5Hp 480VAC	<--->
022LFU	055HFU	NF-CEH20	3 5Hp 230VAC AND 7.5 - 10Hp 480VAC	<--->
037LFU	075HFU			
055LFU	110HFU	NF-CEH30	7.5Hp 230VAC AND 15Hp 480VAC	<--->
075LFU	150HFU	NF-CEH40	10Hp 230VAC AND 20Hp 480VAC	<--->
	185HFU	NF-CEH50	25Hp 480VAC	<--->
110LFU	220HFU	NF-CEH60	15Hp 230VAC AND 30Hp 480VAC	<--->
150LFU	n/a	NF-CEH80	20Hp 230VAC	<--->
185LFU	n/a	NF-CEH100	25Hp 230VAC	<--->
220LFU	n/a	NF-CEH150	30 Hp 230VAC	<--->

NF-CEHxx Dimensions in mm														
Part #	A	B	C	D	E	F	G	H	J	K	L	M	N	P
NF-CEH50	217	200	185	170	120	90	-	115	85	20	R2.75, L7	Ph5.5	M6	M4
NF-CEH60	217	200	185	170	120	90	-	115	85	20	R2.75, L7	Ph5.5	M6	M4
NF-CEH80	217	200	185	170	120	90	-	115	85	20	R2.75, L7	Ph5.5	M6	M4
NF-CEH100	254	230	215	200	150	120	-	115	85	30	R3.25, L8	Ph5.5	M8	M6
NF-CEH150	314	300	280	260	200	170	-	130	90	35	R3.25, L8	Ph5.5	M8	M6

NF-CEH40 to NF-CEH150 dimensions

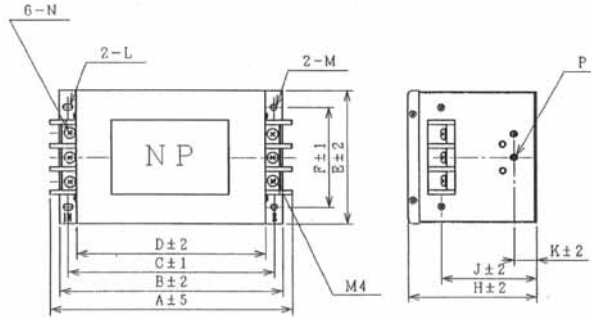

NF-CEH200 to NF-CEH300 dimensions

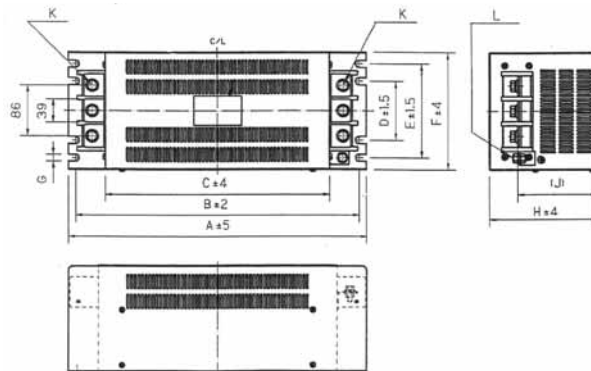

SJ300 Accessories — Option Cards

Encoder feedback board

The SJ-FB encoder feedback board improves the SJ300's speed regulation and torque response. The SJ-FB connects to a two-channel incremental encoder and detects the rotational speed of the motor to prevent speed fluctuations.

The SJ-FB can also be used for master/slave control, electronic line shaft with ratio control, and shaft position control.

SJ-FB Feedback Board			
Price		\$385.00	
Speed control	Encoder Feed-back	Standard encoder pulse number 1024 pulses per revolution Max. input pulse 100k pulses per second	
	Speed Control System	Proportional-integral (PI) / Proportional (P) control	
Electronic Gears Control	Pulse Selection for Electronic Gears	Three kinds of pulse train input selectable by main body setting Mode 0: 90° phase difference pulse Mode 1: forward/reverse signal pulse Mode 2: forward pulse/reverse pulse Max. input pulse 100k pulses	
		Electronic Gears	Pulse ratio A/B (A, B: 1-9999 selectable) Ratio setting range: $1/50 (.02) \leq A/B \leq 20$
			Encoder cable line break protection Over speed protection (over speed error detection level (P026)) Positioning error

Encoder feedback board terminal assignment

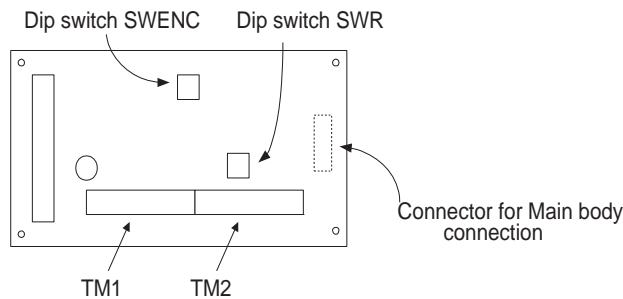

TM1 terminal assignment							TM2 terminal assignment								
EP5	EG5	EAP	EAN	EBP	EBN	EZP	EZN	SAP	SAN	SBP	SBN	AP	AN	BP	BN

Encoder feedback connections

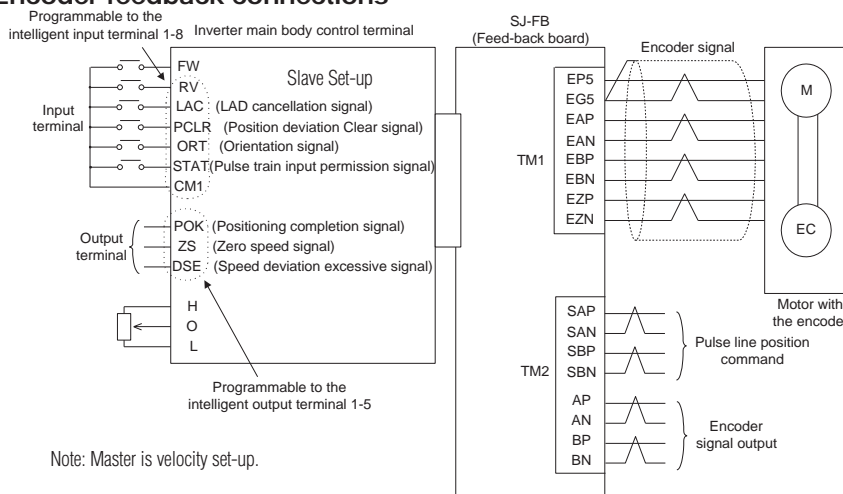

Note: Master is velocity set-up.

Terminal Specifications		
Symbol	Description	Electrical Specifications
Input Terminals		
SAP SAN SBP SBN	Pulse line position command input	DC5V receiver input (based on RS-422 standard)
EAP EAN EBP EBN EZP EZN	Encoder signal input	Photo coupler input (Correspondence to the DC5V line driver type rotary encoder)
STAT	Pulse train position command input permission signal (Note 1)	Photo coupler input (Refer to a main body intelligent input terminal.)
LAC	LAD cancel signal: (Note 1)	
PCLR	Position deviation clear signal: (Note 1)	
Output Terminals		
AP AN BP BN	Encoder signal output	DC5V line driver output (based on RS-422 standard)
EP5 EG5	Power supply for encoder	+5VDC, 150mA max
POK	Positioning completion signal (Note 2)	Open collector outputs (refer to a main body intelligent input terminal)
DSE	Speed deviation excessive signal (Note 2)	
ZS	Zero speed signal (Note 2)	

Note 1: Valid when LAC is assigned to an intelligent input terminal of the main body (SJ300).

Note 2: Valid when POK is assigned to an intelligent output terminal of the main body (SJ300).

SJ300 Configuration, Control and Monitoring

The SJ300 Series drives can be configured multiple ways. The drive can be configured using the removable keypad that comes with the drive (OPE-SRE), the remote digital keypad with serial communications (SC-OPE3I), or the optional Windows-based programming software DOP-PRO, available for free download at www.drivemanager.com. The DOP-PRO-CBL programming cable is required to download configurations to the drive.

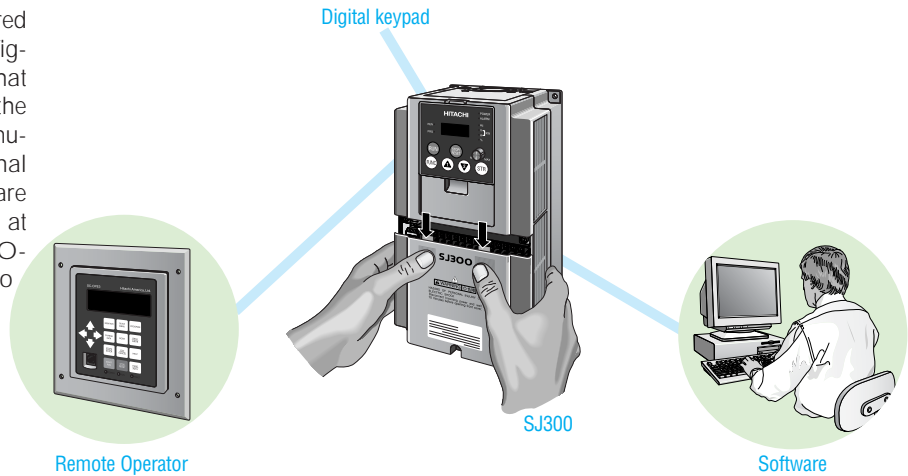

Digital keypad

OPE-SRE (SJ300 Series only)

The OPE-SRE comes standard on every SJ300 Series drive. This keypad has a single line, 4-character LED display. The OPE-SRE can be used to program the drive's parameters as well as monitor specific drive functions.

The OPE-SRE can be mounted on the SJ300 drive or mounted remotely. Use a standard UTP Cat5e Ethernet cable (3m maximum length) for remote mounting. Replacement keypads for the SJ300 are available and come with an extra filler plate.

Digital Keypad		
Part Number	Description	Price
OPE-SRE	Digital remote operator	<--->

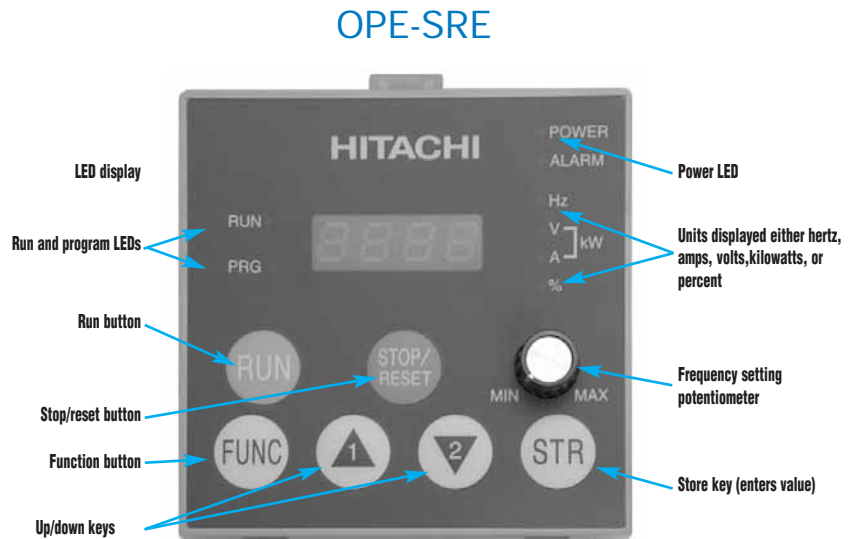

Programming Cable

The DOP-PRO-CBL cable is used to interface a PC to an SJ300 drive using DOP-PRO configuration software. It has a built-in RS232/422 converter and an RJ45 connector.

Programming Cable		
Part Number	Description	Price
DOP-PRO-CBL	Programming cable for DOP-PRO software	<--->

DOP-PRO-CBL

