

RHINO PSB Series DIN rail Power Supplies

Single-Phase Input

AutomationDirect's RHINO PSB series of DIN rail power supplies is perfect for applications that require a basic DC voltage power supply. These low cost power supplies offer high performance and reliability without all the additional features of higher cost full-featured power supplies. The following models in the RHINO PSB series are available with universal single-phase input and with output voltages of 12 and 24VDC from 15 to 480 Watts. The rugged plastic and aluminum housings easily install with integral 35mm DIN-rail mounting adapters. These high-quality power supplies include overload, overvoltage and thermal protection, and are UL 508 listed, UL 60950 recognized, CSA certified, CE marked and RoHS compliant.

Features

- Universal input voltage, 120/240 VAC or 120–375 VDC single phase
- 24VDC or 12VDC outputs, 15 to 480 Watts
- Adjustable output voltage
- Rugged plastic or aluminum housings with integral 35mm DIN-rail mounting adapters
- Output voltage status LED
- Robust fixed-screw terminal strips with finger-safe covers
- Overload, overvoltage and thermal protection
- UL 508 listed, UL 60950 recognized, CSA certified, CE marked and RoHS compliant
- Three year warranty



PSB Single-Phase Series Input Specifications

Part No.	Price	Weight	Housing	Input Voltage	Input Frequency Range	Max. Input Current	Inrush Current Limitation I_{t1} @ 77°F [+25°C] typ.	Leakage Current	Recommended Circuit Breaker	Hold-Up Time at Nominal Load (Typ.) (Mains Buffering)	Turn-on Time	
PSB12-015-P	\$21.50	0.175 kg [0.39 lb]	Plastic	85–264 VAC (DC input range 120–375 VDC); Nominal 100–240 VAC	47–63 Hz (0Hz @ DC Input)	<0.37 A @ 115VAC, <0.22 A @ 230VAC	<30A @ 115 AC, <65A @ 230VAC	<1mA	6A "B" Curve	>22ms @ 115VAC, >110ms @ 230VAC	<2.5 s	
PSB12-030-P	\$23.50	0.197 kg [0.43 lb]	Plastic			<0.7 A @ 115VAC, <0.42 A @ 230VAC	<40A @ 115VAC, <80A @ 230VAC					
PSB12-060	\$37.25	0.325 kg [0.72 lb]	Aluminum			<1.35 A @ 115VAC <0.8 A @ 230VAC	<50A @ 115VAC, <100A @ 230VAC					
PSB12-100	\$56.00	0.636 kg [1.40 lb]	Aluminum			<2.5 A @ 115VAC <1.5 A @ 230VAC	<100A @ 115VAC, no damage @ 230VAC		<3.5 mA	16A "B" Curve	>20ms @ 115VAC, >125ms @ 230VAC	<3s
PSB24-060	\$34.75	0.37 kg [0.82 lb]	Aluminum			<1.1 A @ 115VAC <0.7 A @ 230VAC	<40A @ 115VAC, <80A @ 230VAC					
PSB24-060-P	\$28.00	0.325 kg [0.72 lb]	Plastic			<1.1 A @ 115VAC <0.7 A @ 230VAC	<40A @ 115VAC, <80A @ 230VAC					
PSB24-120	\$63.50	0.54 kg [1.19 lb]	Aluminum			<1.4 A @ 115VAC <0.8 A @ 230VAC	<80A @ 115VAC, <150A @ 230VAC		<1.25 mA		>35ms @ 115VAC, >70ms @ 230VAC	<1s
PSB24-240	\$115.00	1.04 kg [2.29 lb]	Aluminum			<2.9 A @ 115VAC <1.5 A @ 230VAC	<40A @ 115VAC, <100A @ 230VAC					
PSB24-480	\$172.00	1.8 kg [3.97 lb]	Aluminum			<5.7 A @ 115VAC <2.8 A @ 230VAC	<50A @ 115VAC, <150A @ 230VAC					

RHINO PSB Series DIN rail Power Supplies

PSB Single-Phase Series Output Specifications									
Part No.	Output Voltage (Vnom) / Adjustment Range	Output Power	Output Current	Ripple and Noise (20MHz)	Startup with Capacitive Loads	Derating	Max Power Dissipation Idling / Nominal Load Approx.	Efficiency	MTBF
PSB12-015-P	12VDC ±2%/11-14VDC (maximum power <15W)	15W	1.25 A	<100mV	Max 5,000µF	>50°C de-rate power by 2.5%/°C >70°C de-rate power by 4%/°C	≤3.2 W	83.5% Min @ 115VAC & 83% Min @ 230VAC	>300,000 hrs.
PSB12-030-P	12VDC ±2%/11-14VDC (maximum power ≤30W)	30W	2.5 A		Max 6,600µF		≤5.6 W	84.5% Min @ 115VAC & 230VAC	
PSB12-060	12VDC ±2%/11-14VDC (maximum power ≤60W)	60W	5 A		Max 8,000µF		≤10.2 W	85.5% Min @ 115VAC & 230VAC	
PSB12-100	12VDC ±2%/11-14VDC (maximum power ≤100W)	100W	8.33 A		Max 10,000µF		≤16.3 W	86% Min @ 115VAC & 87% Min @ 230VAC	
PSB24-060	24VDC ±2%/22-28VDC (maximum power ≤60W)	60W	2.5 A	<50mV / <240mVpp	Max 8,000µF	>50°C de-rate power by 2.5%/°C <0°C de-rate power by 1%/°C	10W	>85% typical	>800,000 hrs.
PSB24-060-P	24VDC ±2%/22-28VDC (maximum power ≤60W)	60W	2.5 A						
PSB24-120	24VDC ±2%/22-28VDC (maximum power ≤120W)	120W	5 A		Max 10,000µF		22.5 W	>84% typical	
PSB24-240	24VDC ±2%/22-28VDC (maximum power ≤240W)	240W	10A				42.5 W		
PSB24-480	24VDC ±2%/22-28VDC (maximum power ≤480W)	480W	20A		>50°C de-rate power by 2.5%/°C	72W	>86% typical		

PSB Single-Phase Series General Specifications	
Output Line Regulation	<0.5% typical (@ 85-264 VAC input, 100% load)
Output Load Regulation	<1% typical (@ 85-264 VAC input, 0-100% load)
Parallel Operation	PSB60-REM20S, PSB60-REM40S or Oring Diode
Case Cover	Aluminium (Al5052) or Plastic (PC) for P Series
Signals	Green LED DC OK
Humidity at 25°C [77°F], no condensation	<95% RH
Shock	30g half sign, 3 times per direction, 6 directions, per IEC60068-2-27
Vibration (Non-Operating)	10 to 150Hz, 5 g, 90 min. each axis per IEC60068-2-6
Pollution Degree	2
Climatic Class	3K3 according to EN 60721

PSB Single-Phase Series Certification and Standards	
Electrical Equipment of Machines	IEC60204-1 (over voltage category III)
Electronic Equipment for use in Electrical Power Installations	EN 50178 / IEC62103
Safety Entry Low Voltage	PELV (EN 60204), SELV (EN 60950)
Electrical Safety (of information technology equipment)	UR/cUR recognized to UL 60950-1 (file no. E198298), CSA C22.2 No.60950-1 (file no. 249074), CB scheme to IEC60950-1
Industrial Control Equipment	UL listed to UL 508 (file no. E197592), CSA to CSA C22.2 No.107.1-01 (file no. 249074)
Protection Against Electric Shock	DIN 57100-410
CE	In conformance with EMC directive 2004/108/EC and low voltage directive 2006/95/EC

PSB Single-Phase Series Safety and Protection	
Transient surge voltage protection	VARISTOR
Overload/Short Circuit Protection	<150% rated load current, hiccup mode with automatic recovery
Overvoltage Protection	35VDC max.
Isolation Voltage:: Input/output (type test/routine test) Input/GND (type test/routine test) Output/GND (type test/routine test)	4 kVAC / 3 kVAC 1.5 kVAC / 1.5 kVAC 1.5 kVAC / 500VAC
Protection Degree	IP20
Safety Class	Class I with GND connection

RHINO PSB Series DIN rail Power Supplies

Additional Data				
Part No.	Wire Size / Torque*		Ambient Operating Temperature**	Storage Temperature
	Input	Output		
PSB12-015-P PSB12-030-P	0.32–2.1 mm ² [AWG 22–14] / 0.79 Nm [7.0 lb-in]	0.32–2.1 mm ² [AWG 22–14] / 0.79 Nm [7.0 lb-in]	-20°C to 50°C [-4°F to 122°F]	-25°C to 85°C [-13°F to 185°F]
PSB12-060	0.52–2.1 mm ² [AWG 20–14] / 0.78–0.98 Nm [6.94–8.68 lb-in]	0.52–2.1 mm ² [AWG 20–14] / 0.78–0.98 Nm [6.94–8.68 lb-in]		
PSB12-100	0.82–2.1 mm ² [AWG 18–14] / 0.78–0.98 Nm [6.94–8.68 lb-in]	0.82–2.1 mm ² [AWG 18–14] / 0.78–0.98 Nm [6.94–8.68 lb-in]		
PSB24-060 PSB24-060-P PSB24-120 PSB24-240	0.32–2.1 mm ² [AWG 22–14] / 0.78–0.98 Nm [6.94–8.68 lb-in]	0.32–2.1 mm ² [AWG 22–14] / 0.78–0.98 Nm [6.94–8.68 lb-in]	-20°C to 75°C [-4°F to 167°F]	-25°C to 85°C [-13°F to 185°F]
PSB24-480	1.3–2.1 mm ² [AWG 16–14] / 1.18–1.57 Nm [10.41–13.89 lb-in]	3.5–5.3 mm ² [AWG 12–10] / 1.18–1.57 Nm [10.41–13.89 lb-in]		

*Stripping length 7 mm (0.28 in) or use suitable lug to crimp

** See output specifications for temperature derating

Dimensions

mm [inches]

PSB12-015-P
PSB12-030-P

Wiring Connection			
Input		Output	
L	Line	+	Out +
N	Neutral	-	Out -
⊥	AC Ground		

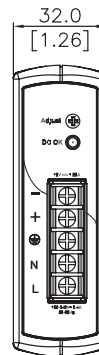
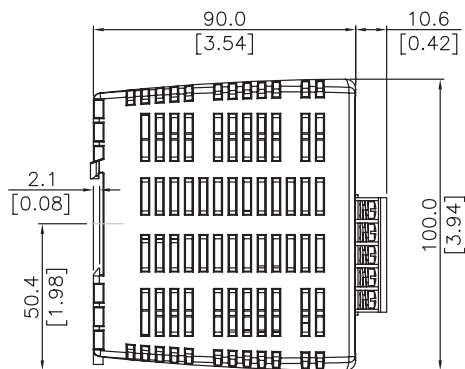
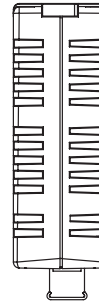

RHINO PSB Series DIN rail Power Supply Dimensions

PSB12-060
PSB24-060

Wiring Connection			
Input		Output	
L	Line	+	Out +
N	Neutral	-	Out -
	AC Ground		

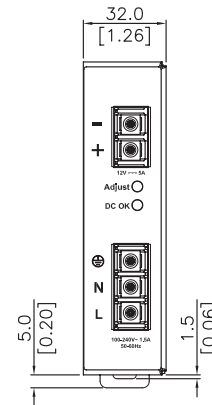
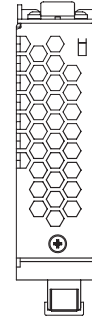
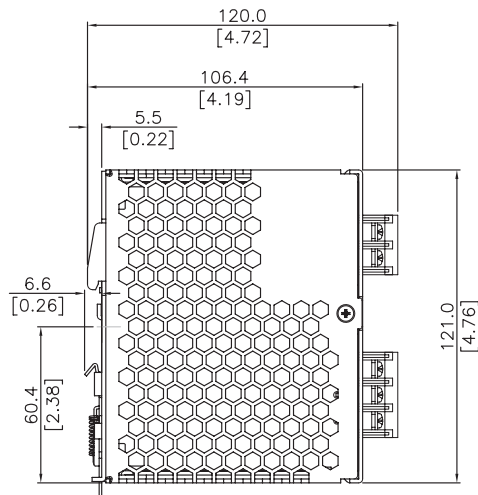

PSB12-100
PSB24-120

Wiring Connection			
Input		Output	
L	Line	+	Out +
N	Neutral	-	Out -
	AC Ground		

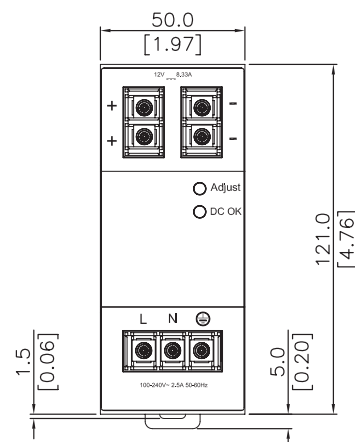
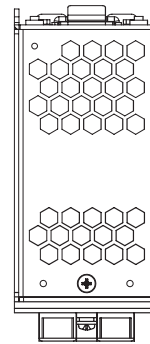
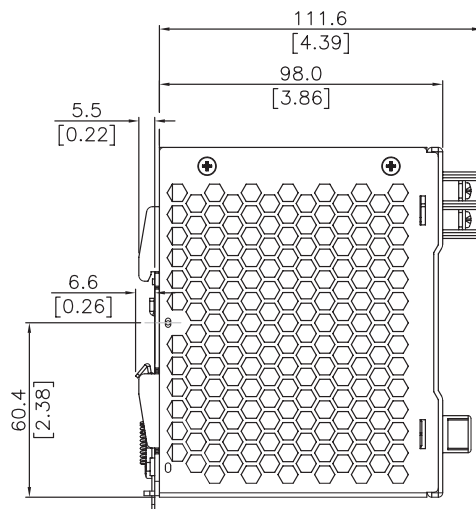

All dimensions in mm [inches]

RHINO PSB Series DIN rail Power Supply Dimensions

Dimensions

mm [inches]

PSB24-060-P

Wiring Connection			
Input		Output	
L	Line	+	Out +
N	Neutral	-	Out -
⏏	AC Ground		

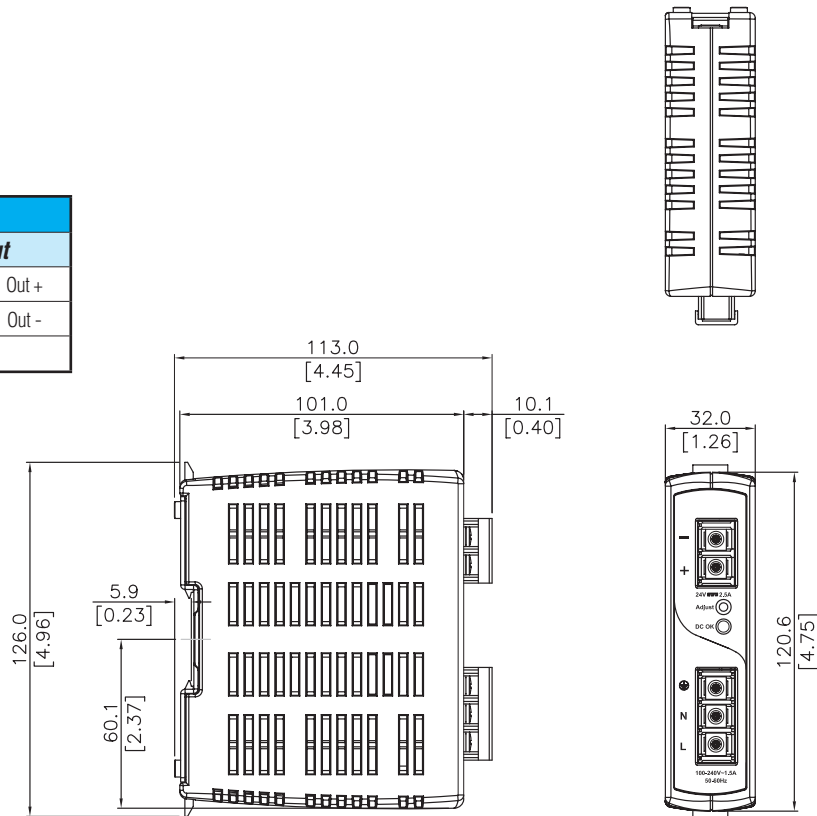

PSB24-240

Wiring Connection			
Input		Output	
L	Line	+	Out +
N	Neutral	+	Out +
⏏	AC Ground	-	Out -
		-	Out -

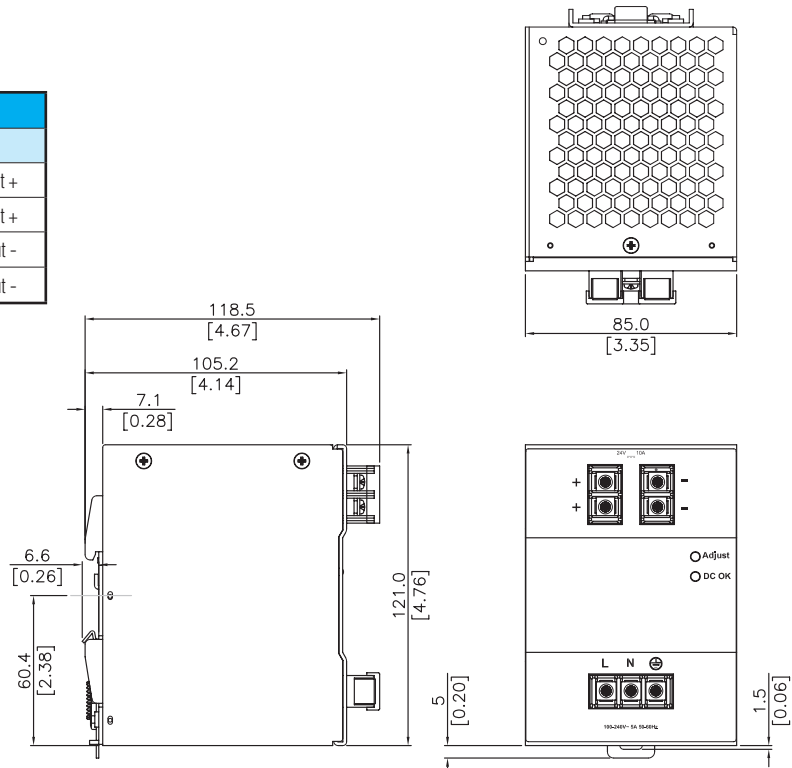

RHINO PSB Series DIN rail Power Supply Dimensions

Dimensions

mm [inches]

PSB24-480

Wiring Connection			
Input		Output	
L	Line	+	Out +
N	Neutral	+	Out +
⏏	AC Ground	-	Out -
		-	Out -

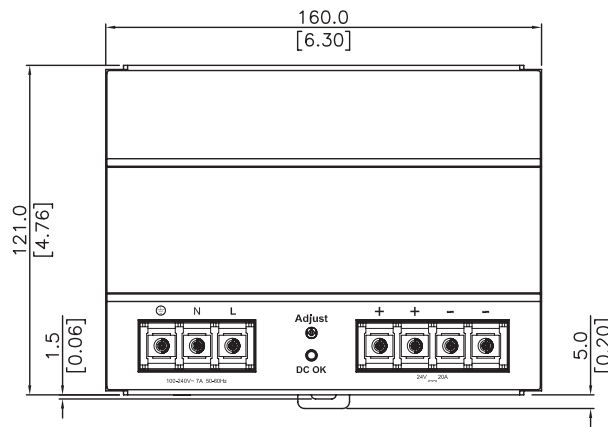
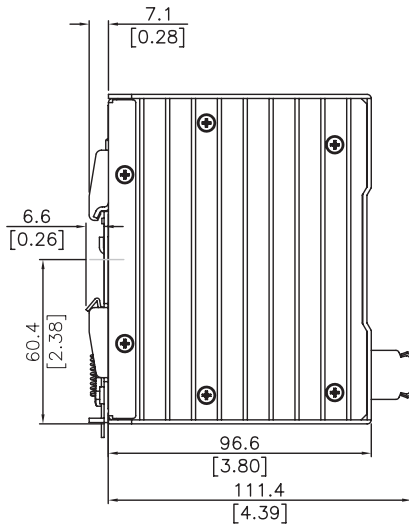
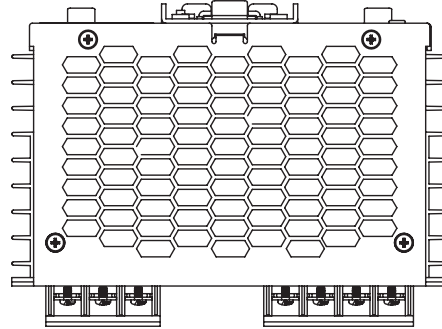

PSB Power Supply Accessories

PSB Series Power Supply Accessories		
Part No.	Price	Description
PSB-CVR	\$5.00	Universal replacement terminal cover kit for all RHINO PSB series power supplies. Universal kit includes (9) terminal covers to replace all terminal covers on any PSB power supply model

