

# pro<sup>sense</sup>® RTD Probes with M12 Cable Connector

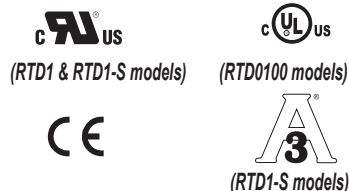

## Overview

- 100 ohm platinum RTD element
- Class A accuracy
- 316 stainless steel sheath to protect from harsh sensing applications
- 6 mm (0.24") diameter 3-wire or 10 mm (0.4") diameter 4-wire probes
- Probe lengths of 30mm, 50mm, 100mm, 150mm, 160 mm, 260 mm, 360 mm, and 560 mm
- Process connections include 1/4" or 1/2" male NPT threads, 3-A approved sanitary CIP tri-clamp, or compression fitting for adjustable insertion depth.
- 4-pin M12 cable connector plug for simplified wiring



RTD Probes With M12 Cable Connector									
Part Number	Wt(lb)	Price	Type	Diameter	Length	Temperature Sensing Range	Process Connection	Thermowell (purchased separately)	Drawing Link
<a href="#">RTD0100-06-010-H</a>	0.10	\$35.00	Pt100, 3-wire	6mm (0.24")	160mm (6.3")	-40 to 302°F (-40 to 150°C)	None, use compression fitting (CF06-25N purchased separately)	RTDTW-06-010-50N CF06-25N	<a href="#">PDF</a>
<a href="#">RTD0100-06-020-H</a>	0.20	\$36.50			260mm (10.24")			RTDTW-06-020-50N CF06-25N	<a href="#">PDF</a>
<a href="#">RTD0100-06-030-H</a>	0.30	\$40.00			360mm (14.17")			RTDTW-06-030-50N CF06-25N	<a href="#">PDF</a>
<a href="#">RTD0100-10-010-H</a>	0.10	\$35.00	Pt100 4-wire	10mm (0.4")	160mm (6.3")	-40 to 302°F (-40 to 150°C)	None, use compression fitting (CF10-50N purchased separately)	RTDTW-10-010-50N CF10-50N	<a href="#">PDF</a>
<a href="#">RTD1-25N-030-H</a>	0.2	\$69.00	Pt100, 3-wire	6mm (0.24")	30mm (1.18")		1/4" Male NPT	None	<a href="#">PDF</a>
<a href="#">RTD1-25N-050-H</a>	0.21	\$70.00			50mm (1.97")				<a href="#">PDF</a>
<a href="#">RTD1-25N-100-H</a>	0.22	\$71.00			100mm (3.94")	<a href="#">PDF</a>			
<a href="#">RTD1-25N-150-H</a>	0.23	\$72.00			150mm (5.91")	<a href="#">PDF</a>			
<a href="#">RTD1-50N-030-H</a>	0.3	\$71.00			30mm (1.18")	<a href="#">PDF</a>			
<a href="#">RTD1-50N-050-H</a>	0.31	\$72.00			50mm (1.97")	<a href="#">PDF</a>			
<a href="#">RTD1-50N-100-H</a>	0.32	\$73.00			100mm (3.94")	TW04-0x STW04-0x	<a href="#">PDF</a>		
<a href="#">RTD1-50N-150-H</a>	0.33	\$74.00			150mm (5.91")	TW06-0x STW06-0x	<a href="#">PDF</a>		
<a href="#">RTD1-S15-030-H</a>	0.41	\$109.00			30mm (1.18")	1-1/2" Sanitary CIP Tri-Clamp (3-A)	None	<a href="#">PDF</a>	
<a href="#">RTD1-S15-050-H</a>	0.42	\$110.00			50mm (1.97")			<a href="#">PDF</a>	
<a href="#">RTD1-S15-100-H</a>	0.44	\$113.00			100mm (3.94")			<a href="#">PDF</a>	
<a href="#">RTD1-S15-150-H</a>	0.44	\$114.00			150mm (5.91")			<a href="#">PDF</a>	



Scan the QR Code or click to view the RTD1 Series product insert.

# pro<sup>sense</sup>® RTD Probes with M12 Cable Connector

RTD Probes With M12 Cable Connector Technical Specifications		
Series	RTD0100 Series	RTD1 Series
Sensing Element	Single 100Ω platinum (Pt100), TCR = 0.00385 Ω/Ω/°C	
Initial Accuracy	DIN EN 60751, Class A, ±(0.15 + 0.002[t])°C	
Probe Diameter	6mm (0.24") or 10mm (0.4")	6mm (0.24")
Minimum Installation Depth	15mm (0.6")	30mm (1.2")
Response Time	*t <sub>0.5</sub> = 1 sec/ t <sub>0.9</sub> = 3 sec (DIN EN 60751)	*t <sub>0.5</sub> = <1 sec/ t <sub>0.9</sub> = <2 sec (DIN EN 60751)
Electrical Connection	4-pin M12 quick disconnect	
Housing Material	Stainless steel (316L)	Stainless steel (304)
Materials (Wetted Parts)	Stainless steel (316L)	Stainless steel (316L)
Protection	IP68 or IP 69K with appropriately rated cable	IP66/67 or IP69K with appropriately rated cable
Ambient Temperature	-13 to 176°F (-25 to 80°C)	-40 to 185°F (-40 to 85°C)
Process Temperature	-40 to 302°F (-40 to 150°C)	-58 to 302°F (-50 to 150°C)
Storage Temperature	-40 to 212°F (-40 to 100°C)	-40 to 185°F (-40 to 85°C)
Pressure Rating	2320 psig (160 bar) maximum	With NPT process connection, 1450 psig (100bar) maximum With Sanitary Tri-clamp process connection, 232 psig (16bar) maximum
Certifications	cULus, CE	cURus, CE, 3-A (RTD1-S models only)

\*t<sub>0.5</sub> = a 50% of full scale change in output when immersed in water flowing at 0.4m/s, t<sub>0.9</sub> = a 90% FS change.



Note: Check the chemical compatibility of the sensor's wetted parts with the medium to be measured.



Note: Response time will be slower when installed in a thermowell. Be sure to install the probe so that it contacts the end of the thermowell for faster response. Thermal compound may be used depending on application.

## Wiring Information RTD0100-06

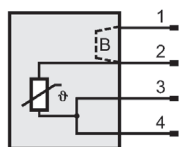

B = Internal Jumper

## Wiring Information RTD0100-10 Series

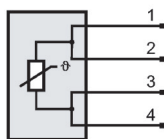

Note: wiring colors are based on AutomationDirect CD12L and CD12M 4-pole cable assemblies.

### Cable Assembly Wiring Colors:

- Pin 1 - Brown
- Pin 2 - White
- Pin 3 - Blue
- Pin 4 - Black

## RTD1 Series

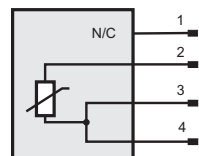

# proSense® Thermowells



## Overview

- Thermowells designed for use with ProSense thermocouple and RTD probes or ProSense Thermometers eliminate the need for a separate probe mounting fitting or adapter

### RTDTW Series Thermowells

- Welded 316 stainless steel construction
- 1/2" NPT male process threads
- 3-year warranty

### TW Series Thermowells

- Drilled bar stock one piece construction (no welds) from 304 or 316 stainless steel
- 1/2" and 3/4" NPT male process threads available
- Designs and fabrication comply with ASME B31.1 and boiler and pressure vessel codes
- Material complies with NACE MR 0175 / ISO 15156
- CRN registered for all Canadian provinces
- 1-year warranty



## Thermowells for Thermocouples -TW Series

Part Number	Pcs/Pkg	Wt(lb)	Price	I.D.	Overall Length/"U" Length	Male Process Threads	Female Probe Threads	Wetted Material	Temperature/Pressure Rating	Use With Probe or Thermometer
<a href="#">TW025-01</a>	1	0.4	\$29.50	0.26"	2-3/4" / 1"	1/2" NPT	1/2" NPT	304 SS	304SS: 1000°F max; 3400psi max 316SS: 1000°F max; 5200psi max	See Sensor Compatibility Table
<a href="#">TW025-03</a>	1	0.4	\$34.50			1/2" NPT		316 SS		
<a href="#">TW04-01</a>	1	0.5	\$34.00		4-1/4" / 2-1/2"	1/2" NPT		304 SS		
<a href="#">TW04-02</a>	1	0.5	\$34.00			3/4" NPT		304 SS		
<a href="#">TW04-03</a>	1	0.5	\$42.50			1/2" NPT		316 SS		
<a href="#">TW04-04</a>	1	0.5	\$42.50			3/4" NPT		316 SS		
<a href="#">TW06-01</a>	1	0.7	\$46.00		6-1/4" / 4-1/2"	1/2" NPT		304 SS		
<a href="#">TW06-02</a>	1	0.7	\$46.00			3/4" NPT		304 SS		
<a href="#">TW06-03</a>	1	0.7	\$54.00			1/2" NPT		316 SS		
<a href="#">TW06-04</a>	1	0.7	\$54.00			3/4" NPT		316 SS		
<a href="#">TW09-01</a>	1	1.0	\$67.00		9-1/4" / 7-1/2"	1/2" NPT		304 SS		
<a href="#">TW09-03</a>	1	1.0	\$78.00			1/2" NPT		316 SS		
<a href="#">TW12-01</a>	1	1.2	\$74.00		12-1/4" / 10-1/2"	1/2" NPT		304 SS		
<a href="#">TW12-02</a>	1	1.2	\$74.00			3/4" NPT		304 SS		
<a href="#">TW12-03</a>	1	1.2	\$93.00			1/2" NPT		316 SS		
<a href="#">TW12-04</a>	1	1.2	\$93.00			3/4" NPT		316 SS		

# pro<sup>sense</sup> Thermowells

Thermowells for Thermocouples -RTDTW Series										
Part Number	Pcs/Pkg	Wt(lb)	Price	I.D.	Overall Length	Male Process Threads	Female Probe Threads	Wetted Material	Temperature/Pressure Rating	Use With
<a href="#"><u>RTDTW-06-010-50N</u></a>	1	0.10	\$34.00	7 mm (0.28")	113mm (4.4")	1/2" NPT	1/4" NPT	316 SS	600°F (315°C) max; 232 psi (16 bar) max	XTP-160-N40140F XTP-160-0300F XTP-160-0100C RTD0100-06-010-H CF06-25N fitting
<a href="#"><u>RTDTW-06-020-50N</u></a>	1	0.20	\$36.50		213mm (8.4")					XTP-260-N40140F XTP-260-0300F XTP-260-0100C RTD0100-06-020-H CF06-25N fitting
<a href="#"><u>RTDTW-06-030-50N</u></a>	1	0.30	\$40.00		313mm (12.3")					XTP-360-N40140F XTP-360-0300F XTP-360-0100C RTD0100-06-030-H CF06-25N fitting
<a href="#"><u>RTDTW-10-010-50N</u></a>	1	0.10	\$34.00	11 mm (0.43")	92mm (3.62")	1/2" NPT				RTD0100-10-010-H CF10-50N fitting
<a href="#"><u>RTDTW-10-030-50N</u></a>	1	0.22	Retired		292mm (11.48")					CF10-50N fitting



Note: Check the chemical compatibility of the thermowell's wetted parts with the medium to be measured.



Note: Response time will be slower when installed in a thermowell. Be sure to install the probe so that it contacts the end of the thermowell for faster response. Thermal compound may be used depending on application

## Probe & Thermowell Assembly Example

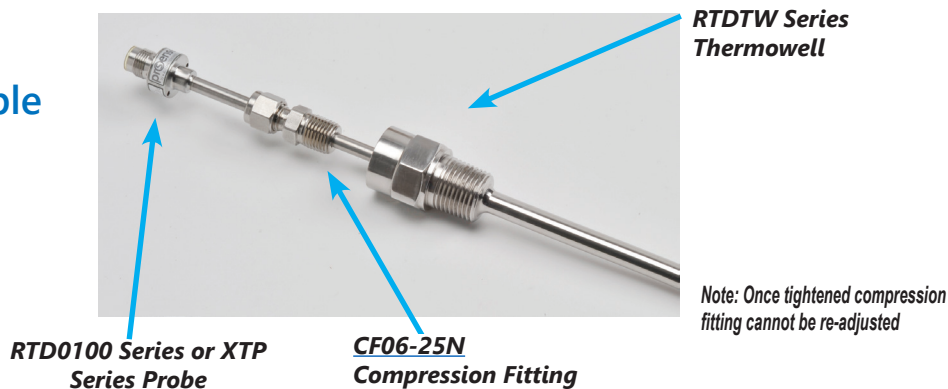

## Spring-loaded Thermocouple or RTD and Thermowell Assembly Example

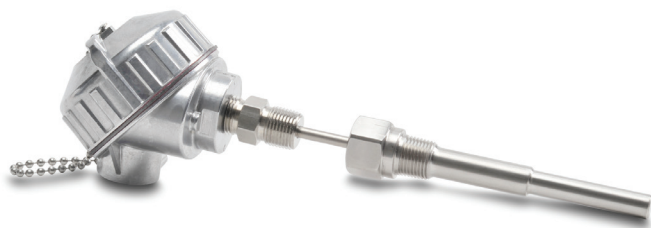

- Using spring-loaded probe design ensures positive tip contact with the bottom of the thermowell.
- Probes with hex nipple thread directly into thermowell. No additional probe mounting fittings are required.

# proSense® Thermowells

## Dimensions

inches [mm]

TW04-XX & TW025-XX

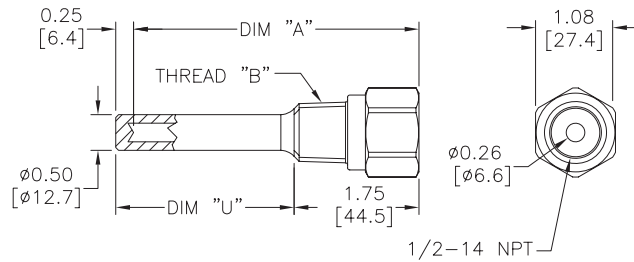

PART NUMBER	DIM "A"	THREAD "B" NPT	DIM "U"
TW025-01	2.50[63.5]	1/2-14	1.00[25.5]
TW025-03	2.50[63.5]	1/2-14	
TW04-01	4.00[101.6]	1/2-14	
TW04-02	4.00[101.6]	3/4-14	2.50[63.5]
TW04-03	4.00[101.6]	1/2-14	
TW04-04	4.00[101.6]	3/4-14	

## Dimensions

inches [mm]

TW06-XX  
TW09-XX  
TW12-XX

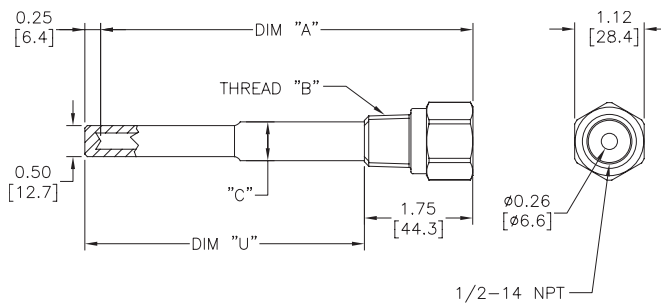

PART NUMBER	DIM "A"	THREAD "B" NPT	DIM "C"	DIM "U"
TW06-01	6.00[152.4]	1/2-14	0.63[15.9]	4.50[114.3]
TW06-02	6.00[152.4]	3/4-14	0.75[19.1]	
TW06-03	6.00[152.4]	1/2-14	0.63[15.9]	
TW06-04	6.00[152.4]	3/4-14	0.75[19.1]	7.50[190.5]
TW09-01	9.00[228.6]	1/2-14	0.63[15.9]	
TW09-03	9.00[228.6]	1/2-14	0.63[15.9]	
TW12-01	12.00[304.8]	1/2-14	0.63[15.9]	10.50[266.7]
TW12-02	12.00[304.8]	3/4-14	0.75[19.1]	
TW12-03	12.00[304.8]	1/2-14	0.63[15.9]	
TW12-04	12.00[304.8]	3/4-14	0.75[19.1]	

# proSense® Thermowells

## Dimensions

mm [inches]

### RTDTW-06 Series

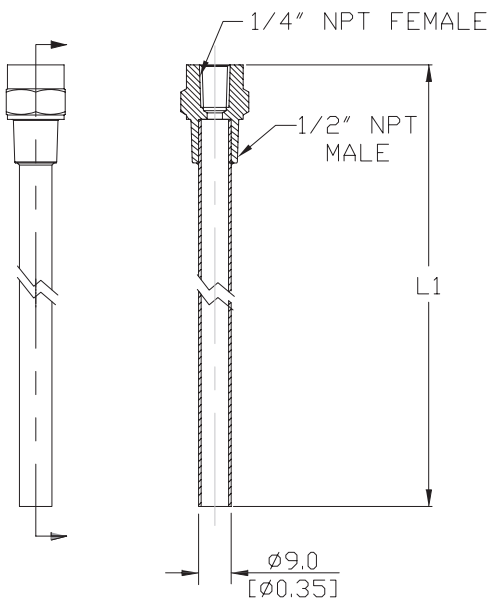

Part Number	L1
<a href="#">RTDTW-06-010-50N</a>	113mm [ 4.4]
<a href="#">RTDTW-06-020-50N</a>	213mm [ 8.4]
<a href="#">RTDTW-06-030-50N</a>	313mm [12.3]

Torque threads to 40 lb-ft [54.23 Nm]\*

\* Torque values are for reference. Actual torque required for a proper seal of NPT threads is influenced by tolerance, sealant, lubricant, etc.



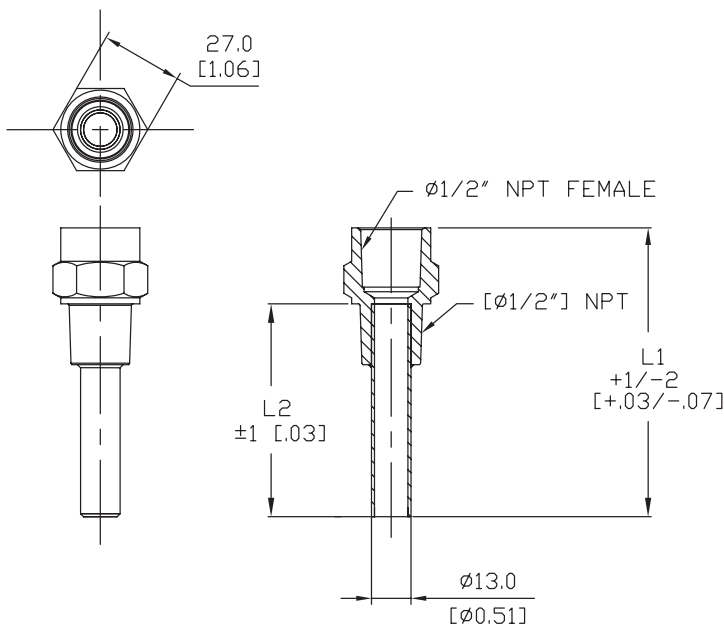



### RTDTW-10 Series



Part Number	L1	L2
<a href="#">RTDTW-10-030-50N</a>	92mm [ 3.62]	70mm [ 2.75]
<a href="#">RTDTW-10-050-50N</a>	292mm [11.48]	270mm [10.6]

Torque threads to 40 lb-ft [54.23 Nm]\*

# proSense® Thermowells

TW Series Thermowells Sensor Compatibility Table						
	Connection Head	Hex Nipple	Attached Plug	Lead Wire Transition	M12	Thermometer
<b>Thermowell</b>						
<b>TW025-01</b> <b>TW025-03</b>	-	-	-	-	-	T30-N40160-25C T30-0250-25C T30-50500-25C T30-150750-25C T50-N40160-25A T50-0250-25A T50-50500-25A T50-150750-25A
<b>TW04-01</b> <b>TW04-02</b> <b>TW04-03</b> <b>TW04-04</b>	RTD1-C04-03 THMJ-C04-03 THMK-C04-03	RTD1-H04L01-02 THMJ-H04L01-02 THMK-H04L01-02	RTD1-P06-01 w/CF14-50N THMJ-P06-02 w/CF14-50N THMK-P06-02 w/CF14-50N	RTD1-T06L06-01 w/CF14-50N THMJ-T06L06-02 w/CF14-50N THMK-T06L06-02 w/CF14-50N	RTD1-50N-100-H RTD100-06-010-H w/CF14-50N XTP-160-N40140F w/CF14-50N XTP-160-0300F w/CF14-50N XTP-160-0100C w/CF14-50N XTP50N-100-N40140F XTP50N-100-0300F XTP50N-100-0100C ETS50N-100-1001 ETS50N-100-1003	T30-N40160-4C T30-0250-4C T30-50500-4C T30-150750-4C T50-N40160-4A T50-0250-4A T50-50500-4A T50-150750-4A
<b>TW06-01</b> <b>TW06-02</b> <b>TW06-03</b> <b>TW06-04</b>	RTD1-C06-03 THMJ-C06-03 THMK-C06-03	RTD1-H06L01-02 THMJ-H06L01-02 THMK-H06L01-02	RTD1-P12-01 w/CF14-50N THMJ-P12-02 w/CF14-50N THMK-P12-02 w/CF14-50N	RTD1-T12L06-01 w/CF14-50N THMJ-T12L06-02 w/CF14-50N THMK-T12L06-02 w/CF14-50N	RTD1-50N-150-H RTD100-06-020-H w/CF14-50N XTP-260-N40140F w/CF14-50N XTP-260-0300F w/CF14-50N XTP-260-0100C w/CF14-50N XTP50N-150-N40140F XTP50N-150-0300F XTP50N-150-0100C ETS50N-150-1001 ETS50N-150-1003	T30-N40160-6C T30-0250-6C T30-50500-6C T30-150750-6C T50-N40160-6A T50-0250-6A T50-50500-6A T50-150750-6A
<b>TW09-01</b> <b>TW09-03</b>	-	-	-	-	-	T50-N40160-9A T50-0250-9A T50-50500-9A T50-150750-9A
<b>TW12-01</b> <b>TW12-02</b> <b>TW12-03</b> <b>TW12-04</b>	RTD1-C12-03 THMJ-C12-03 THMK-C12-03	RTD1-H12L01-02 THMJ-H12L01-02 THMK-H12L01-02	RTD1-P18-01 w/CF14-50N THMJ-P18-02 w/CF14-50N THMK-P18-02 w/CF14-50N	RTD1-T18L06-01 w/CF14-50N THMJ-T18L06-02 w/CF14-50N THMK-T18L06-02 w/CF14-50N	RTD100-06-030-H w/CF14-50N XTP-360-N40140F w/CF14-50N XTP-360-0300F w/CF14-50N XTP-360-0100C w/CF14-50N	-



Note: Response time will be slower when installed in a thermowell. Be sure to install the probe so that it contacts the end of the thermowell for faster response. Thermal compound may be used depending on application

# proSense® Thermowells Sanitary Clean-in-Place (CIP)



STW06-01

## Overview

- Sanitary Clean-In-Place 3-A approved thermowells allow the use of standard temperature sensors in hygienic applications
- All wetted parts are 316 stainless steel
- Surface finish that meets or exceeds 32µin Ra
- Up to 1500/1200 psi (103/83 bar) at 70/250 °F (21/121 °C) dependent on clamp and seal assembly.
- Bore diameter of 0.260" to accommodate sensing probes with a 0.252" maximum diameter
- Probes with integral 1/2" male NPT process threads mount directly into the thermowell. Probes without threads require a compression fitting with 1/2" male NPT threads.



Thermowells Sanitary Clean-in-Place (CIP)									
Part Number	Pcs/Pkg	Wt(lb)	Price	I.D.	Overall Length/"U" Length	Process Connection	Female Probe Threads	Wetted Material	Use With
<a href="#">STW04-01</a>	1	0.75	\$101.00	ø0.260	4-1/4" / 2-1/2"	1-1/2" tri-clamp	1/2" NPT	316 stainless steel	See Sensor Compatibility Table
<a href="#">STW06-01</a>	1	0.88	\$108.00		6-1/4" / 4-1/2"				
<a href="#">STW12-01</a>	1	1.13	\$150.00		12-1/4" / 10-1/2"				
<a href="#">STW04-02</a>	1	0.75	\$112.00		4-1/4" / 2-1/2"	2" tri-clamp			
<a href="#">STW06-02</a>	1	0.88	\$120.00		6-1/4" / 4-1/2"				
<a href="#">STW12-02</a>	1	1.13	\$156.00		12-1/4" / 10-1/2"				

- Note: Check the chemical compatibility of the thermowell's wetted parts with the medium to be measured.
- Note: Response time will be slower when installed in a thermowell. Be sure to install the probe so that it contacts the end of the thermowell for faster response. Thermal compound may be used depending on application

## Probe & Thermowell Assembly Example

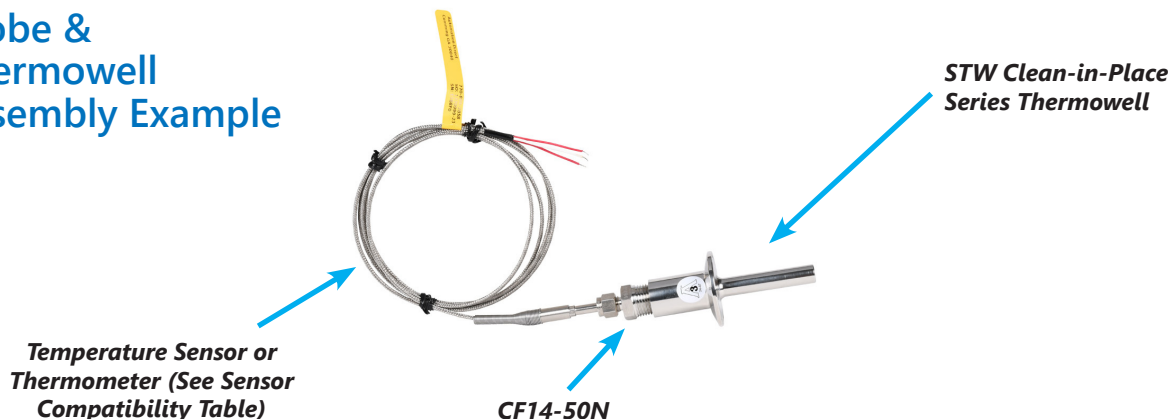



# proSense® Thermowells Sanitary Clean-in-Place (CIP)

## Spring-loaded Thermocouple or RTD and Thermowell Assembly Example



- Using spring-loaded probe design ensures positive tip contact with the bottom of the thermowell.
- Probes with hex nipple thread directly into thermowell. No additional probe mounting fittings are required.

### Dimensions





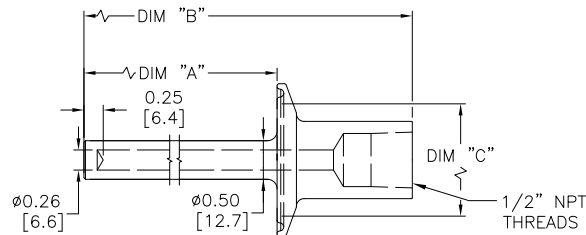

inches [mm]

STWXX-XX



PART NUMBER	DIM "A"	DIM "B"	DIM "C"
STW04-01	2.50[63.5]	4.25[108.0]	1.50[38.1]
STW06-01	4.50[114.3]	6.25[158.8]	1.50[38.1]
STW12-01	10.50[266.8]	12.25[311.3]	1.50[38.1]
STW04-02	2.50[63.5]	4.25[108.0]	2.00[50.8]
STW06-02	4.50[114.3]	6.25[158.5]	2.00[50.8]
STW12-02	10.50[266.8]	12.25[311.3]	2.00[50.8]

# pro<sup>sense</sup> Thermowells Sanitary Clean-in-Place (CIP)

Thermowells Sanitary Clean-in-Place (CIP) Sensors Compatibility Table						
	Connection Head Sensor	Hex Nipple Sensor	Attached Plug Sensor	Lead Wire Transition Sensor	M12 Sensor	Thermometer
<b>Thermowell</b>						
<b>STW04-01</b>	RTD1-C04-03 THMJ-C04-03 THMK-C04-03	RTD1-H04L01-02 THMJ-H04L01-02 THMK-H04L01-02	RTD1-P06-01 w/CF14-50N THMJ-P06-02 w/CF14-50N THMK-P06-02 w/CF14-50N	RTD1-T06L06-01 w/CF14-50N THMJ-T06L06-02 w/CF14-50N THMK-T06L06-02 w/CF14-50N	RTD1-50N-100-H RTD0100-06-010-H w/CF14-50N XTP-160-N40140F w/CF14-50N XTP-160-0300F w/CF14-50N XTP-160-0100C w/CF14-50N XTP50N-100-N40140F XTP50N-100-0300F XTP50N-100-0100C ETS50N-100-1001 ETS50N-100-1003	T30-N40160-4C T30-0250-4C T30-50500-4C T30-150750-4C T50-N40160-4A T50-0250-4A T50-50500-4A T50-150750-4A
<b>STW06-01</b>	RTD1-C06-03 THMJ-C06-03 THMK-C06-03	RTD1-H06L01-02 THMJ-H06L01-02 THMK-H06L01-02	RTD1-P12-01 w/CF14-50N THMJ-P12-02 w/CF14-50N THMK-P12-02 w/CF14-50N	RTD1-T12L06-01 w/CF14-50N THMJ-T12L06-02 w/CF14-50N THMK-T12L06-02 w/CF14-50N	RTD1-50N-150-H RTD0100-06-020-H w/CF14-50N XTP-260-N40140F w/CF14-50N XTP-260-0300F w/CF14-50N XTP-260-0100C w/CF14-50N XTP50N-150-N40140F XTP50N-150-0300F XTP50N-150-0100C ETS50N-150-1001 ETS50N-150-1003	T30-N40160-6C T30-0250-6C T30-50500-6C T30-150750-6C T50-N40160-6A T50-0250-6A T50-50500-6A T50-150750-6A
<b>STW12-01</b>	RTD1-C12-03 THMJ-C12-03 THMK-C12-03	RTD1-H12L01-02 THMJ-H12L01-02 THMK-H12L01-02	RTD1-P18-01 w/CF14-50N THMJ-P18-02 w/CF14-50N THMK-P18-02 w/CF14-50N	RTD1-T18L06-01 w/CF14-50N THMJ-T18L06-02 w/CF14-50N THMK-T18L06-02 w/CF14-50N	RTD0100-06-030-H w/CF14-50N XTP-360-N40140F w/CF14-50N XTP-360-0300F w/CF14-50N XTP-360-0100C w/CF14-50N	-
<b>STW04-02</b>	RTD1-C04-03 THMJ-C04-03 THMK-C04-03	RTD1-H04L01-02 THMJ-H04L01-02 THMK-H04L01-02	RTD1-P06-01 w/CF14-50N THMJ-P06-02 w/CF14-50N THMK-P06-02 w/CF14-50N	RTD1-T06L06-01 w/CF14-50N THMJ-T06L06-02 w/CF14-50N THMK-T06L06-02 w/CF14-50N	RTD1-50N-100-H RTD0100-06-010-H w/CF14-50N XTP-160-N40140F w/CF14-50N XTP-160-0300F w/CF14-50N XTP-160-0100C w/CF14-50N XTP50N-100-N40140F XTP50N-100-0300F XTP50N-100-0100C ETS50N-100-1001 ETS50N-100-1003	T30-N40160-4C T30-0250-4C T30-50500-4C T30-150750-4C T50-N40160-4A T50-0250-4A T50-50500-4A T50-150750-4A
<b>STW06-02</b>	RTD1-C06-03 THMJ-C06-03 THMK-C06-03	RTD1-H06L01-02 THMJ-H06L01-02 THMK-H06L01-02	RTD1-P12-01 w/CF14-50N THMJ-P12-02 w/CF14-50N THMK-P12-02 w/CF14-50N	RTD1-T12L06-01 w/CF14-50N THMJ-T12L06-02 w/CF14-50N THMK-T12L06-02 w/CF14-50N	RTD1-50N-150-H RTD0100-06-020-H w/CF14-50N XTP-260-N40140F w/CF14-50N XTP-260-0300F w/CF14-50N XTP-260-0100C w/CF14-50N XTP50N-150-N40140F XTP50N-150-0300F XTP50N-150-0100C ETS50N-150-1001 ETS50N-150-1003	T30-N40160-6C T30-0250-6C T30-50500-6C T30-150750-6C T50-N40160-6A T50-0250-6A T50-50500-6A T50-150750-6A
<b>STW12-02</b>	RTD1-C12-03 THMJ-C12-03 THMK-C12-03	RTD1-H12L01-02 THMJ-H12L01-02 THMK-H12L01-02	RTD1-P18-01 w/CF14-50N THMJ-P18-02 w/CF14-50N THMK-P18-02 w/CF14-50N	RTD1-T18L06-01 w/CF14-50N THMJ-T18L06-02 w/CF14-50N THMK-T18L06-02 w/CF14-50N	RTD0100-06-030-H w/CF14-50N XTP-360-N40140F w/CF14-50N XTP-360-0300F w/CF14-50N XTP-360-0100C w/CF14-50N	-

 Note: Response time will be slower when installed in a thermowell. Be sure to install the probe so that it contacts the end of the thermowell for faster response. Thermal compound may be used depending on application

# pro<sup>sense</sup>® Compression Mounting Fittings for Temperature Probes

Compression Mounting Fittings for Temperature Probes				
Part Number	Description	Pcs/Pkg	Wt(lb)	Price
<a href="#"><b>BCF18-125N</b></a>	Compression fitting, brass, for 1/8 inch diameter temperature probes, 1/8 inch NPT male thread	1	0.5	\$3.25
<a href="#"><b>BCF14-125N</b></a>	Compression fitting, brass, for 1/4 inch diameter temperature probes, 1/8 inch NPT male thread	1	0.5	\$3.25
<a href="#"><b>BCF18-25N</b></a>	Compression fitting, brass, for 1/8 inch diameter temperature probes, 1/4 inch NPT male thread	1	0.5	\$4.25
<a href="#"><b>BCF14-25N</b></a>	Compression fitting, brass, for 1/4 inch diameter temperature probes, 1/4 inch NPT male thread	1	0.5	\$4.25
<a href="#"><b>BCF18-50N</b></a>	Compression fitting, brass, for 1/8 inch diameter temperature probes, 1/2 inch NPT male thread	1	0.5	\$6.00
<a href="#"><b>BCF14-50N</b></a>	Compression fitting, brass, for 1/4 inch diameter temperature probes, 1/2 inch NPT male thread	1	0.5	\$6.50
<a href="#"><b>CF18-125N</b></a>	Compression fitting, 316 stainless steel, for 1/8 inch diameter temperature probes, 1/8 inch NPT male thread	1	0.5	\$8.00
<a href="#"><b>CF14-125N</b></a>	Compression fitting, 316 stainless steel, for 1/4 inch diameter temperature probes, 1/8 inch NPT male thread	1	0.5	\$8.00
<a href="#"><b>CF18-25N</b></a>	Compression fitting, 316 stainless steel, for 1/8 inch diameter temperature probes, 1/4 inch NPT male thread	1	0.5	\$9.25
<a href="#"><b>CF14-25N</b></a>	Compression fitting, 316 stainless steel, for 1/4 inch diameter temperature probes, 1/4 inch NPT male thread	1	0.5	\$9.25
<a href="#"><b>CF18-50N</b></a>	Compression fitting, 316 stainless steel, for 1/8 inch diameter temperature probes, 1/2 inch NPT male thread	1	0.5	\$13.50
<a href="#"><b>CF14-50N</b></a>	Compression fitting, 316 stainless steel, for 1/4 inch diameter temperature probes, 1/2 inch NPT male thread	1	0.5	\$14.00
<a href="#"><b>CFTF-18**</b></a>	Teflon™ ferrule for brass or stainless steel compression fittings and 1/8 diameter temperature probes	5	0.5	\$7.25
<a href="#"><b>CFTF-14**</b></a>	Teflon ferrule for brass or stainless steel compression fittings and 1/4 diameter temperature probes	5	0.5	\$7.75
<a href="#"><b>CF06-25N</b></a>	1/4 NPT stainless steel compression fitting for 0.24 inch (6 mm) diameter RTD probe with M12 connector.	1	0.18	\$28.50
<a href="#"><b>CF10-50N</b></a>	1/2 NPT stainless steel compression fitting for 10 mm (0.4 inch) diameter RTD probe with M12 connector.	1	0.20	\$30.00
<a href="#"><b>CF18-BC</b></a>	Bayonet compression fitting, for 1/8" diameter probe sheath sensors	1	0.1	\$10.00
<a href="#"><b>BB125N-50N</b></a>	Reducing bushing, brass, 1/2 MNPT x 1/8 FNPT, hex head	1	0.1	\$5.75

[\*\*BCF18-125N\*\*](#)



[\*\*BCF18-25N\*\*](#)



[\*\*BCF18-50N\*\*](#)



[\*\*BB125N-50N\*\*](#)



Note: Check the chemical compatibility of the sensor's wetted parts with the medium to be measured.

\* Working pressure of compression fitting should not exceed 500 psi. However we recommend any pressure application use a thermowell

\*\* Teflon has a max working temperature range of -400 to 500°F (-240 to 260°C)

[\*\*CFTF-14\*\*](#)



[\*\*CFTF-18\*\*](#)



[\*\*CF14-125N\*\*](#)



[\*\*CF14-50N\*\*](#)

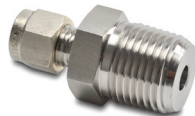

[\*\*CF14-25N\*\*](#)



[\*\*CF18-BC\*\*](#)



[\*\*CF06-25N\*\*](#)



[\*\*CF10-50N\*\*](#)



# pro<sup>sense</sup>® Compression Mounting Fittings for Temperature Probes

**BCF14-125N**



**BCF14-25N**



**BCF14-50N**



**CF18-25N**



**CF18-50N**



**CF18-125N**



## Dimensions

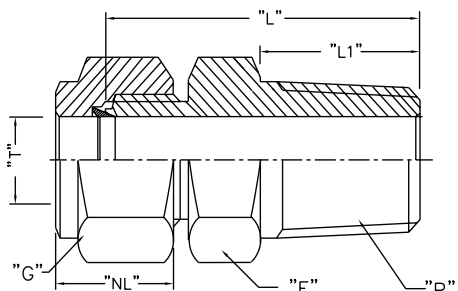

Note: All threaded connections should be hand tightened and then turned 1 to 2 full turns for proper sealing.

Actual torque required for a proper seal of NPT threads is influenced by tolerance, sealant, lubricant, etc.

ProSense Compression Fittings									
Part No.	Weight (lb)	Description	"T" Tube O.D.	"P" NPT(M)	"L" Body Length*	"L1" Thread Length**	"F" Body Hex**	"G" Nut Hex**	"NL" Nut Length**
<b>BCF18-125N/CF18-125N</b>	0.5	1/8" OD x 1/8" NPT(M)	0.128/0.132	1/8" NPT(M)	0.909"	0.393"	0.5"	0.433"	0.492"
<b>BCF14-125N/CF14-125N</b>	0.5	1/4" OD x 1/8" NPT(M)	0.253/0.257	1/8" NPT(M)	1.0"	0.393"	0.5"	0.559"	0.5"
<b>BCF18-25N/CF18-25N</b>	0.5	1/8" OD x 1/4" NPT(M)	0.128/0.132	1/4" NPT(M)	1.114"	0.551"	0.551"	0.433"	0.492"
<b>BCF14-25N/CF14-25N</b>	0.5	1/4" OD x 1/4" NPT(M)	0.253/0.257	1/4" NPT(M)	1.188"	0.551"	0.551"	0.559"	0.5"
<b>BCF18-50N/CF18-50N</b>	0.5	1/8" OD x 1/2" NPT(M)	0.128/0.132	1/2" NPT(M)	1.377"	0.748"	0.866"	0.433"	0.492"
<b>BCF14-50N/CF14-50N</b>	0.5	1/4" OD x 1/2" NPT(M)	0.253/0.257	1/2" NPT(M)	1.437"	0.748"	0.866"	0.559"	0.5"
<b>CF06-25N</b>	0.18	6 mm OD x 1/4" NPT(M)	0.236/0.240	1/4" NPT(M)	1.174"	0.59"	0.67"	0.55"	0.587"
<b>CF10-50N</b>	0.20	10 mm OD x 1/2" NPT(M)	0.394/0.399	1/2" NPT(M)	1.458"	0.55"	1.06"	0.75"	0.608"

Note: All dimensions are in inches

\* w 0.07

\*\* w 0.03

Note: Once the compression fitting has been fully tightened on the probe, the ferrule will be locked onto the probe and cannot be removed or reused.

\*Working pressure of compression fitting should not exceed 500 psi. However we recommend any pressure application use a thermowell



Scan the QR Code or click to view the CF06 & CF10 Compression Fitting Installation Instructions



# Bayonet Mounting Adapter for Temperature Sensors

Bayonet Mounting Adapter for Temperature Sensors					
Part Number	Description	Material	Pcs/Pkg	Wt(lb)	Price
<a href="#"><u>BA-078</u></a>	Bayonet adapter, 7/8 inch long, 7/16 inch outside diameter, 9/32 inch inside diameter, 1/8 inch MNPT	Stainless Steel (304)	1	0.5	\$1.75
<a href="#"><u>BA-100</u></a>	Bayonet adapter, 1 inch long, 7/16 inch outside diameter, 9/32 inch inside diameter, 1/8 inch MNPT		1	0.5	\$1.75
<a href="#"><u>BA-114</u></a>	Bayonet adapter, 1-1/4 inch long, 7/16 inch outside diameter, 9/32 inch inside diameter, 1/8 inch MNPT		1	0.5	\$2.25
<a href="#"><u>BA-112</u></a>	Bayonet adapter, 1-1/2 inch long, 7/16 inch outside diameter, 9/32 inch inside diameter, 1/8 inch MNPT		1	0.5	\$2.25
<a href="#"><u>BA-200</u></a>	Bayonet adapter, 2 inch long, 7/16 inch outside diameter, 9/32 inch inside diameter, 1/8 inch MNPT		1	0.5	\$2.50
<a href="#"><u>BA-212</u></a>	Bayonet adapter, 2-1/2 inch long, 7/16 inch outside diameter, 9/32 inch inside diameter, 1/8 inch MNPT		1	0.5	\$2.75
<a href="#"><u>BA-300</u></a>	Bayonet adapter, 3 inch long, 7/16 inch outside diameter, 9/32 inch inside diameter, 1/8 inch MNPT		1	0.5	\$3.00
<a href="#"><u>BA-312</u></a>	Bayonet adapter, 3-1/2 inch long, 7/16 inch outside diameter, 9/32 inch inside diameter, 1/8 inch MNPT		1	0.5	\$3.50
<a href="#"><u>CF18-BC</u></a>	Adjustable bayonet compression fitting, for 1/8" diameter probe sheath sensors		Brass	1	0.1
<a href="#"><u>BB125N-50N</u></a>	Reducing bushing, 1/2 MNPT x 1/8 FNPT, hex head	1		0.1	\$5.75

[BA-078](#)



[BA-100](#)



[BA-114](#)



*Note: Check the chemical compatibility of the sensor's wetted parts with the medium to be measured.*

[CF18-BC](#)



[BA-300](#)



[BA-112](#)



[BB125N-50N](#)



[BA-312](#)



[BA-200](#)



[BA-212](#)



# ProSense® Pipe Clamp Adapters

**PCA-300**

## Overview

- For use with ProSense adjustable immersion thermocouple and RTD sensors
- Available in adjustable diameters from 11/16 to 7 inches
- Provides an easy means of sensing temperature on the outside of a pipe

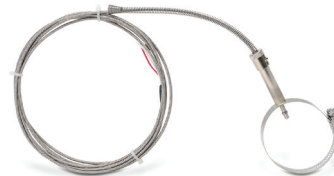

Shown with optional adjustable immersion sensor

## Pipe Clamp Adapters for ProSense Adjustable Immersion Sensors

Part Number	Description	Pcs/ Pkg	Wt(lb)	Price
<b>PCA-125</b>	ProSense pipe clamp adapter, 11/16 to 1-1/4 inch adjustable diameter, 2-inch attached bayonet adapter with 7/16 inch outside diameter and 9/32 inch inside diameter. Use with ProSense adjustable immersion sensors.	1	0.1	\$17.50
<b>PCA-200</b>	ProSense pipe clamp adapter with 1-1/16 to 2 inch adjustable diameter, 2-inch attached bayonet adapter with 7/16 inch outside diameter and 9/32 inch inside diameter. Use with ProSense adjustable immersion sensors.	1	0.1	\$18.00
<b>PCA-300</b>	ProSense pipe clamp adapter with 2-1/16 to 3 inch adjustable diameter, 2-inch attached bayonet adapter with 7/16 inch outside diameter and 9/32 inch inside diameter. Use with ProSense adjustable immersion sensors.	1	0.1	\$20.00
<b>PCA-425</b>	ProSense pipe clamp adapter with 3-5/16 to 4-1/4 inch adjustable diameter, 2-inch attached bayonet adapter with 7/16 inch outside diameter and 9/32 inch inside diameter. Use with ProSense adjustable immersion sensors.	1	0.1	\$22.50
<b>PCA-500</b>	ProSense pipe clamp adapter with 4-1/8 to 7 inch adjustable diameter, 2-inch attached bayonet adapter with 7/16 inch outside diameter and 9/32 inch inside diameter. Use with ProSense adjustable immersion sensors.	1	0.1	\$21.00

## Dimensions

inches [mm]

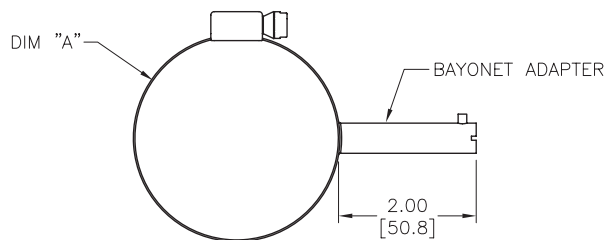

TABLE A

PART NUMBER	DIM "A"	FITS PIPE SIZES
PCA-125	ø0.68–1.25 [ø17.2–31.7]	1/2 TO 3/4 NPS
PCA-200	ø1.06–2.00 [ø26.9–50.8]	1 TO 1-1/2 NPS
PCA-300	ø2.06–3.00 [ø52.3–76.2]	2 TO 2-1/2 NPS
PCA-425	ø3.31–4.25 [ø84.1–108.0]	3 TO 3-1/2 NPS
PCA-500	ø4.12–7.00 [ø104.6–177.8]	4 TO 6 NPS