

RHINO PSM24-REM360S Redundancy Module

Using two PSM24 power supplies and a redundancy module, you can configure a redundant power system, featuring active current sharing, without any additional components. Even if one power supply fails or becomes disconnected, the second unit will supply full current to the load. The module has an alarm contact for monitoring of operations. The inputs are hot-swappable and can be loaded up to 15A each.



Redundancy Module					
Part Number	Price	Input	Max Power per Input	Output Voltage Adjust	Output Power Max
PSM24-REM360S (includes terminal plugs)	\$159.00	2 x 24 VDC 2 x Control Input	2 x 360 W	24 VDC (24 - 27 VDC)	360 W

General Specifications	
Operating Temperature	-25°C to +70°C max (-13°F to +158°F), derating above 40°C (104°F)
Electromagnetic Compatibility	In correspondence to connected units (no internal switching device)
Redundancy OK Signal	Trigger threshold at 18 to 22 VDC. Contact closed if one or both inputs failed
Dimensions	Same as model PSM24-090S (see dimensions page)
Remote Link Wire 0.5m	Two cables included with PSM24-REM360S module
Remote ON/OFF	By external contact: ON = J5.3 + J5.4 not shorted OFF = J5.3 + J5.4 shorted
Alarm Contact Rating	30 VDC/1.0 A max

Redundancy Module Function Diagram

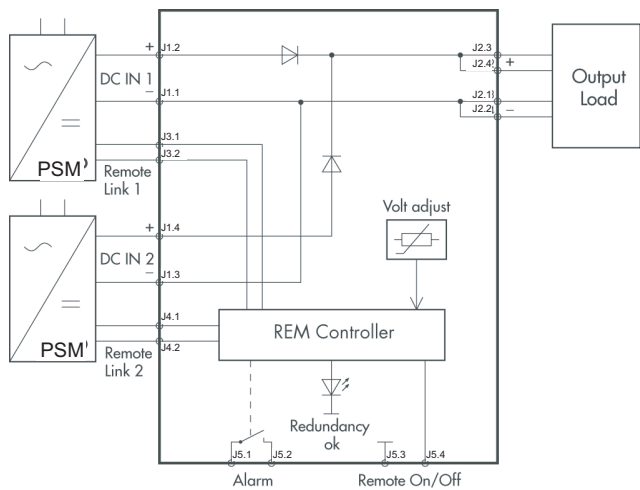

Redundancy Module Connector Positions

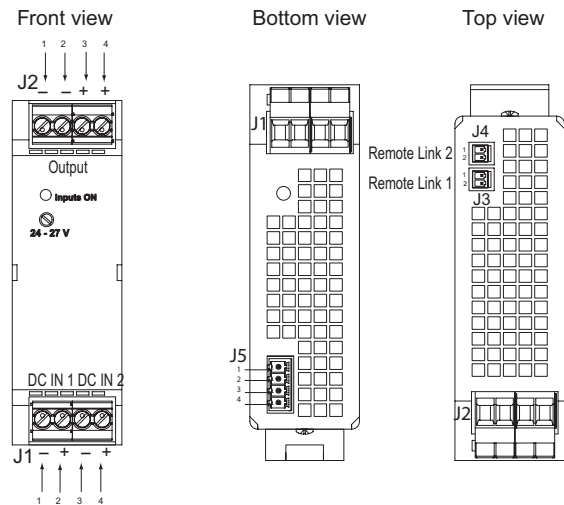

Note: this redundancy module only works with the PSM series. Other series of power supplies are not compatible.

	J1	J2	J3 Voltage control 1 for Input 1	J4 Voltage control 2 for Input 2	J5
Pin 1	Input 1 -Vin	GND (-)	S+	S+	DC-OK Signal
Pin 2	Input 1 +Vin	GND (-)	S-	S-	DC-OK Relay contact
Pin 3	Input 2 -Vin	Vout (+)	—	—	Remote ON/OFF
Pin 4	Input 2 +Vin	Vout (+)	—	—	Remote ON/OFF

RHINO PSM Power Supplies - Accessories

A variety of accessories is available to complement the RHINO PSM power supplies. Choose panel mounting brackets and replacement plug kits from the table below, based on the size of the power supply. There is also a temperature sensor for the battery control module and replacement link cable for the redundancy and battery control modules.

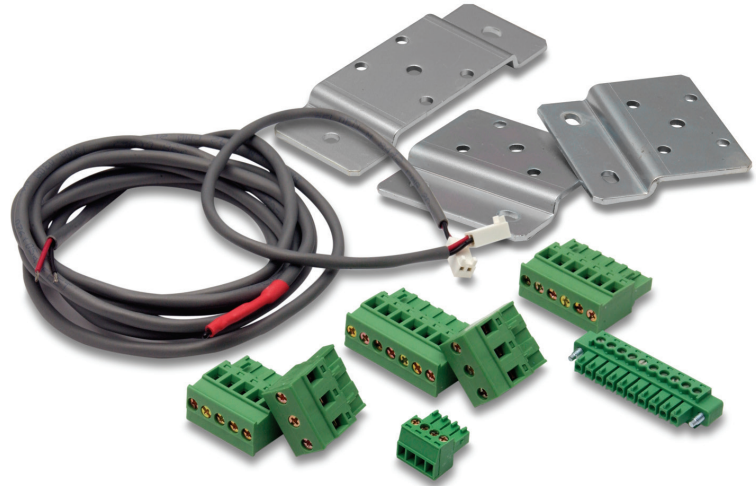

Accessories		
Part Number	Price	Description
PSM-PANEL1	\$30.00	Panel mounting bracket. 1 bracket type A includes M4-screw (DIN 74-4fA) for 78W, 90W, 156W, 180W PSM power supplies
PSM-PANEL2	\$27.00	Panel mounting bracket. 2 brackets type A include M4-screws (DIN 74-4fA) for 360W, 600W PSM power supplies
PSM-PK1	\$6.00	Replacement plug kit for PSM series with 78W and 90W outputs
PSM-PK2	\$9.00	Replacement plug kit for PSM series with 156W, 180W and 360W outputs
PSM-TS	\$27.00	Temperature sensor for PSM24-BCM360S battery control module
PSM-JC01	\$7.00	Replacement link cable for PSM series redundancy module PSM24-REM360S and battery control module PSM24-BCM360S

Mounting

PSM power supplies are designed for mounting on a DIN rail. Please allow minimum free space of 80 mm (3.15") above and below, and 50 mm (1.97") on each side of the power supply for air convection. To attach unit onto the DIN rail, hook the top part of clip on DIN rail, then push down and inward until you hear the clipping sound. To remove, pull the latch of the clip using an insulated flat-head screwdriver.

For wall or chassis mounting, use mounting brackets PSM-PANEL1 (for 78W to 180W PSM style power supplies) or PSM-PANEL2 (for 360W and 600W PSM power supplies). Remove the DIN clips and replace with the brackets. Use the countersink screws included with the wall mount kit to attach the brackets to the power supply.

To attach the power supply to the DIN rail

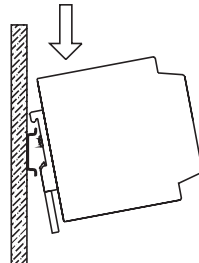

Fig. 2.1

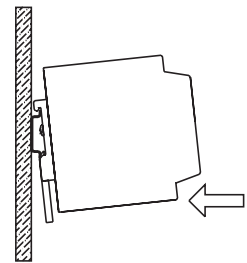

Fig. 2.2

To remove the power supply from DIN rail

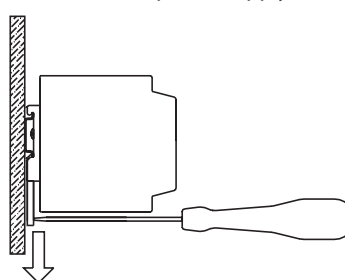

Fig. 2.3

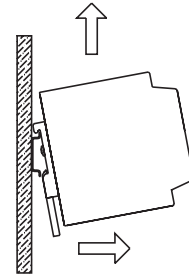
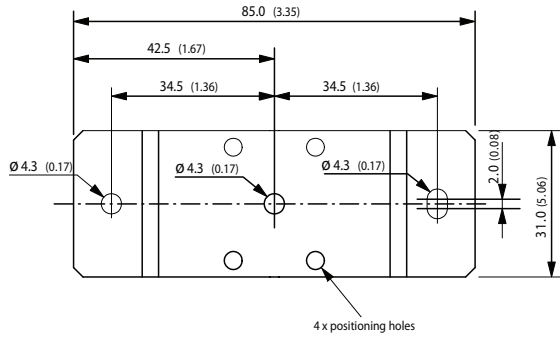

Fig. 2.4

RHINO PSM Panel Mounting Bracket Dimensions

PSM-PANEL1



Material: 2 mm Mild Steel
Tolerance: $\pm 0.1\text{mm}$ (± 0.004)

PSM12-078S, PSM24-090S

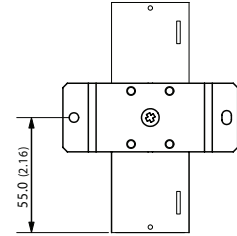

PSM12-156S, PSM24-180S

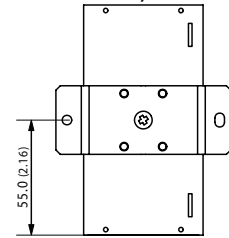

PSM-PANEL2

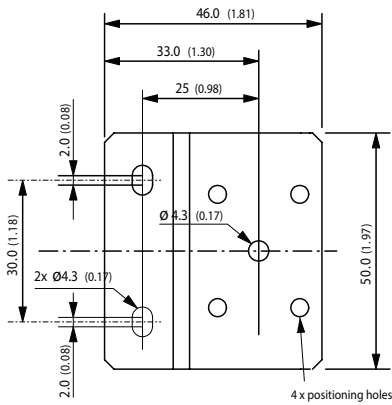

Material: 2 mm Mild Steel
Tolerance: $\pm 0.1\text{mm}$ (± 0.004)

Dimensions: [mm] () = Inch

PSM24-360S

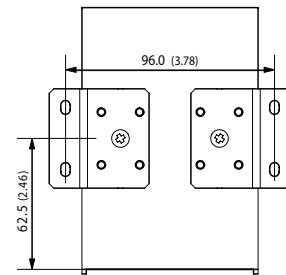

PSM24-600S

