



Pneumatic Pushbuttons, 22mm Key Operated & Double Headed

Mushroom pushbutton operator - key operated (40mm dia. actuator)



ECP3141

Part Number	Color	Description	Weight (lbs)	Price
ECP3141	Red	NITRA pneumatic pushbutton, IP65, 22mm, key operated release, plastic base, plastic bezel, black, operator only, Operator: red, mushroom, 40mm, round, plastic.	0.19	\$12.00



Note: Keyed switches come with two keys. All plastic 22mm keyed switches are keyed the same. Replacement keys are available. Order part no. ECX1067-2 (pkg. of 2). Keys for plastic 22mm keyed switches are not compatible with Cutler-Hammer key switches.

Dimensions mm [inches]

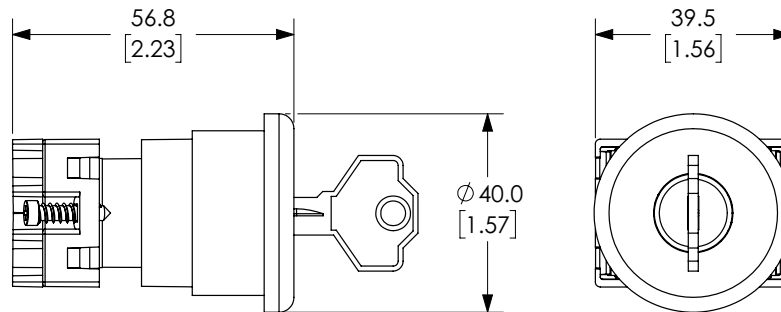

Double headed pushbutton operator



ECP3150



ECP3152

Part Number	Color	Description	Weight (lbs)	Price
ECP3150	Green/Red	NITRA pneumatic pushbutton, IP65, 22mm, momentary, plastic base, plastic bezel, black, operator only, Operator: green and red, double headed, rectangular, plastic.	0.08	\$5.25
ECP3152	Green/Red	NITRA pneumatic pushbutton, IP65, 22mm, momentary, plastic base, plastic bezel, black, operator only, Operator: green and red, double headed, rectangular, plastic, operator text "(I) and (O)".	0.08	\$6.00

Dimensions mm [inches]

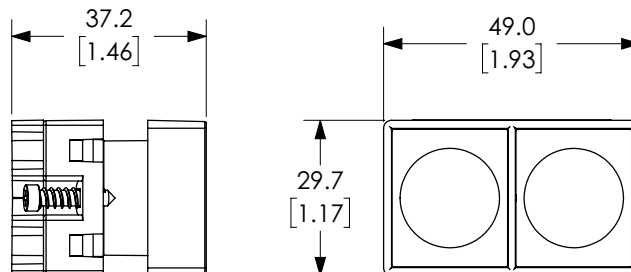

See our website www.AutomationDirect.com for complete Engineering drawings.



Pneumatic Key Selector Switches, 22mm

Key selector switches



ECP3420

Part Number	Color	Description	Weight (lbs)	Price
ECP3420	Black	NITRA pneumatic selector switch, IP65, 22mm, 2-position, maintained, key removable in all positions, plastic base, plastic bezel, operator only, Operator: black, key, 30mm, round, plastic.	0.17	\$12.00
ECP3430	Black	NITRA pneumatic selector switch, IP65, 22mm, 2-position, spring return from right, key removable left position, plastic base, plastic bezel, operator only, Operator: black, key, 30mm, round, plastic.	0.17	\$12.00
ECP3470	Black	NITRA pneumatic selector switch, IP65, 22mm, 3-position, maintained, key removable in all positions, plastic base, plastic bezel, operator only, Operator: black, key, 30mm, round, plastic.	0.17	\$11.00



Note: Keyed switches come with two keys. All plastic 22mm keyed switches are keyed the same. Replacement keys are available. Order part no. ECX1067-2 (pkg. of 2). Keys for plastic 22mm keyed switches are not compatible with Cutler-Hammer key switches.



ECP3470

Dimensions mm [inches]

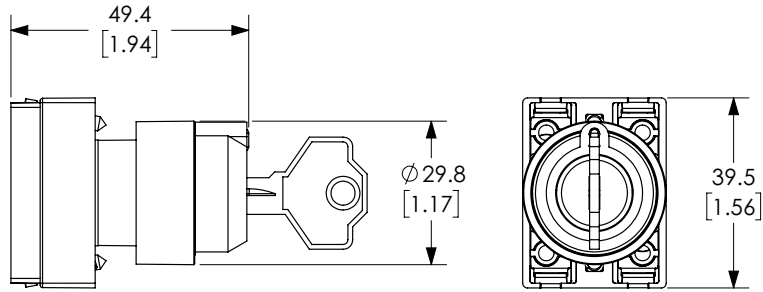

Pneumatic switch accessory - support base with adapters



ECP3029-02

Part Number	Description	Weight (lbs)	Price
ECP3029-02	NITRA valve adapter block, replacement, plastic. For use with ECP series pneumatic pushbuttons.	0.03	\$1.00

Dimensions mm [inches]

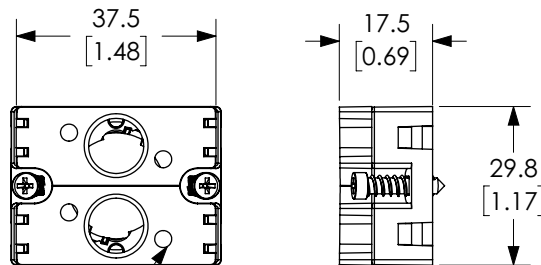

M3 THRU HOLE SCREWS INCLUDED

Note: base sold as three piece kit.

See our website www.AutomationDirect.com for complete Engineering drawings.



Pneumatic Pushbuttons, 22mm

NITRA® pneumatic pushbuttons are all plastic and come with adapters to allow mounting of up to two 3-way valves, or one valve and one to three contact blocks. They fit in a standard 22.5mm hole, just like electrical pushbuttons.

Features

- Plastic bezel and button
- Valve adapters and mounting screws included
- Valves sold separately
- Bases will work with GCX plastic operators and **only** the three ECX Series contact blocks shown below



Pushbutton Specifications	
Operating Temperature	-13 to 158°F (-25 to +70°C)
Storage Temperature	-40 to 176°F (-40 to +80°C)
Mechanical Life	1,000,000 cycles
Switching Cycles	3600 cycles/hr
Mounting (Valve)	(4) M3x5 valve mounting screws included
Protection	IP65 after installation
Approvals	CE

Adapter Block Installation

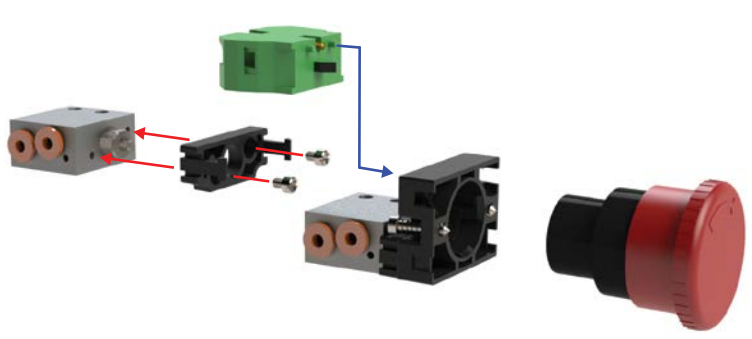
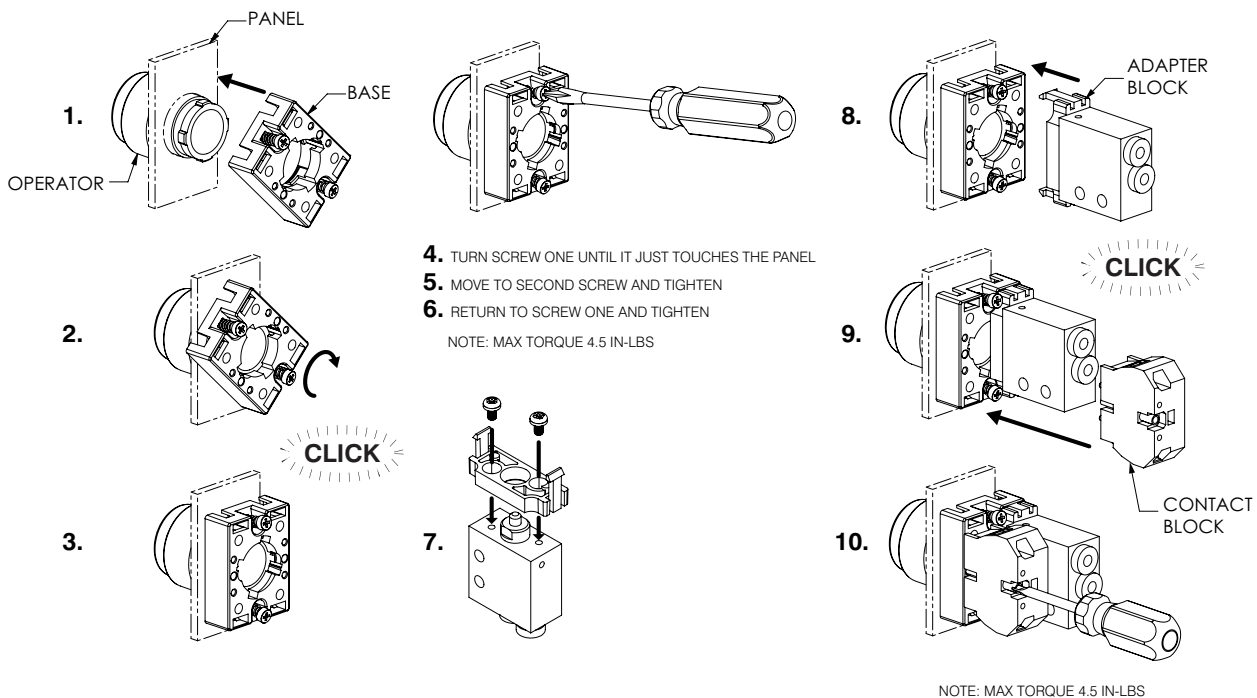

ECX1040-2



ECX1042-2



ECX1030-2



Pneumatic Manual Valves

Pneumatic Manual Valve Materials

1. Aluminum valve body
2. Chemically nickel-plated brass button
3. Brass distance plates
4. NBR gaskets
5. Stainless steel, brass and plastic push-to-connect cartridges
6. Stainless steel springs

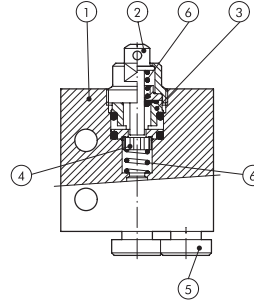

Pneumatic Metal Plunger Valves

These pneumatic valves are used with Nitra pneumatic pushbuttons and switches

Features

- Available in normally open or normally closed
- 5/32" [4mm] push-to-connect ports located on side or end

Valve Symbols

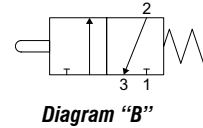
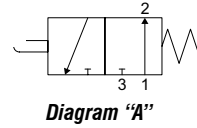

Specifications				
Models	<i>EVP-CA-PL</i>	<i>EVP-AA-PL</i>	<i>EVP-CS-PL</i>	<i>EVP-AS-PL</i>
Price	\$21.50	\$23.50	\$19.00	\$21.50
Weight (lbs)	0.1	0.1	0.1	0.1
Valve Type	2-port (3-way) 2-position			
Acting	Metal plunger, normally closed, spring return	Metal plunger, normally open, spring return	Metal plunger, normally closed, spring return	Metal plunger, normally open, spring return
Diagram	B	A	B	A
Port Size	Axial ports 5/32in (4mm)		Side ports 5/32in (4mm)	
Flow (Cv)	0.13	0.13	0.13	0.13
Fluid	Air (to be filtered by 40µ filter element)			
Min. / Max. Pressure	7.25 to 145 psi (0.5 to 10 bar)			
Temperature	14°F to 140°F (-10°C to 60°C)			
Lubrication	Not Required			
Body	Aluminum			
Protection	IP65			



EVP-CA-PL



EVP-CS-PL

Dimensions mm [inches]

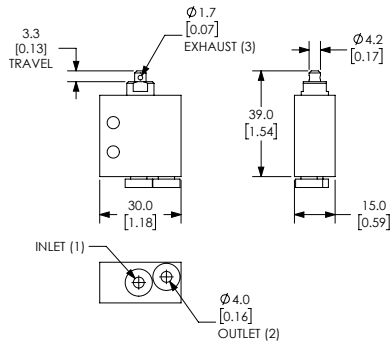

EVP-CA-PL

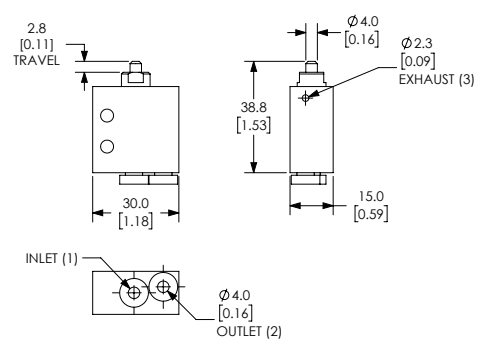

EVP-AA-PL

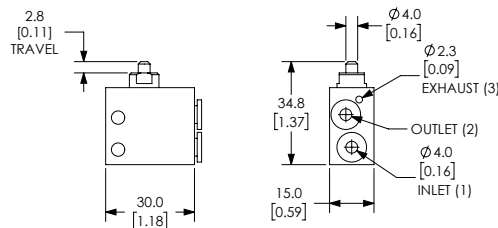

EVP-CS-PL / EVP-AS-PL

See our website www.AutomationDirect.com for complete Engineering drawings.