

P3-550 CPU Module - Communications

Port Specifications

The P3-550 CPU has seven communications ports. The following pages list specifications and pin-out diagrams for these ports.

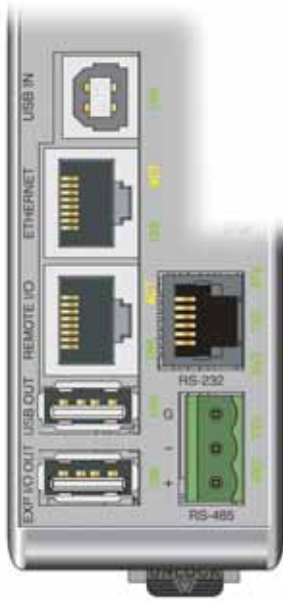

USB IN Port

Used exclusively for connecting to a PC running the Productivity Suite programming software.

USB Type B Slave Input Specifications	
Port Name	USB IN
Description	Standard USB 2.0 Slave input for programming and online monitoring, with built-in surge protection. Not compatible with older full speed USB devices.
Transfer Rate	480 Mbps
Port Status LED	Green LED is illuminated when LINK is established to programming software.
Cables	USB Type A to USB Type B: 3 ft. cable part # USB-CBL-AB3 6 ft. cable part # USB-CBL-AB6 10 ft. cable part # USB-CBL-AB10 15 ft. cable part # USB-CBL-AB15

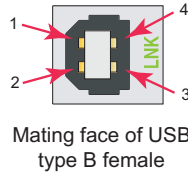

Pin #	Signal
1	+5
2	-Data
3	+Data
4	GND

Ethernet Port

- RJ-45 style connector used for:
- Connection to a PC running the Productivity Suite programming software
 - Modbus TCP Client connections (Modbus requests sent from the P3-550)
 - Modbus TCP Server connections (Modbus requests received by the P3-550)
 - Outgoing E-mail

Remote I/O Port

RJ-45 style connector used for connecting to a Remote I/O network consisting of P3-RS Remote Slaves and/or GS-EDRV100 units with GS drives.

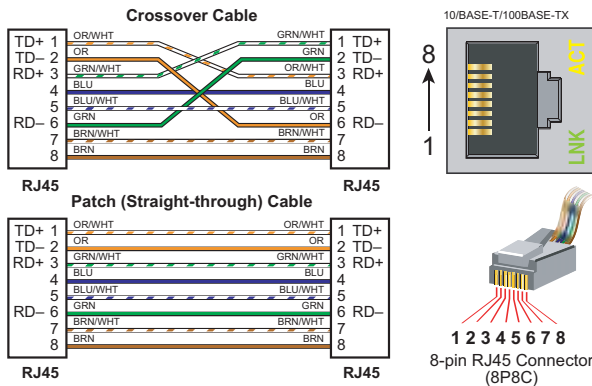

Ethernet Specifications		
Port Name	ETHERNET	REMOTE I/O
Description	Standard transformer isolated Ethernet port with built-in surge protection for programming, online monitoring, Email (SMTP client) and Modbus/TCP client/server connections (fixed IP or DHCP).	Standard transformer isolated Ethernet port with built-in surge protection for connection to the P3-RS Remote I/O system. Supports 32 Remote I/O slaves and 64 GS Series drives.
Transfer Rate	10/100 Mbps	
Port Status LED	Green LED illuminated when network LINK is established. Yellow LED is illuminated when port is active (ACT).	
Cables	Use a Patch (straight through) cable when a switch or hub is used. Use a Crossover cable (not offered by ADC) when a switch or hub is not used.	

P3-550 CPU Module - Communications

Port Specifications

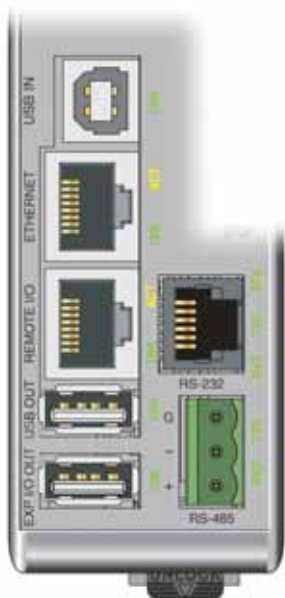

USB OUT Port

Used for data logging or project transfers to and from a SDCZ4-2048-A10 Pen Drive.

EXP I/O OUT Port

USB port used only for Expansion I/O connections to local P3-EX modules in a Productivity3000 base with I/O.

USB Type A Master Output Specifications

Port Name	USB OUT	EXP I/O OUT
Description	Standard USB 2.0 Master output for connection to high-speed Flash drive (Sandisk SDCZ4-2048-A10) for data logging or program transfer with built-in surge protection. Not compatible with older full speed USB devices. A 0.5m male-to-female "port extender" cable is included to assist with Flash drive connection.	Proprietary USB 2.0 Master output for connection with up to four P3-EX local expansion bases, with built-in surge protection.
Transfer Rate	480 Mbps	
Port Status LED	Green LED is illuminated when LINK is established to connected device	
Cables	None required	USB Type A to USB Type B: 6 ft. cable part # P3-EX-CBL6 (included with P3-EX module)

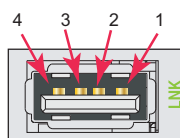

Mating face of USB type A female

USB OUT

Pin #	Signal
1	+5
2	- Data
3	+ Data
4	GND

RS-232 Port

RJ-12 style connector used for:

- Modbus RTU Master connections
- Modbus RTU Slave connections
- ASCII Incoming and Outgoing communications
- Custom Protocol Incoming and Outgoing communications

EXP I/O OUT

Pin #	Signal
1	Reset
2	- Data
3	+ Data
4	GND

RS-232 Specifications

Port Name	RS-232
Description	Non-isolated RS-232 DTE port connects the CPU as a Modbus/ASCII master or slave to a peripheral device. Includes ESD and built-in surge protection.
Data Rates	Selectable, 1200, 2400, 9600, 19200, 33600, 38400, 57600, and 115200.
+5V Cable Power Source	210mA maximum at 5V, +/- 5%. Reverse polarity and overload protected.
TXD	RS-232 Transmit output
RXD	RS-232 Receive input
RTS	Handshaking output for modem control.
GND	Logic ground
Maximum Output Load (TXD/RTS)	3K Ω , 1,000pf
Minimum Output Voltage Swing	+/-5V
Output Short Circuit Protection	+/-15mA
Port Status LED	Green LED is illuminated when active for TXD, RXD and RTS
Cable Options	D2-DSCBL USB-RS232 with D2-DSCBL FA-CABKIT FA-ISOCAN for converting RS-232 to isolated RS-485

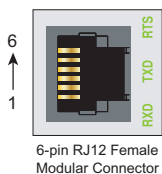

6-pin RJ12 Female Modular Connector

Pin #	Signal
1	GND Logic Ground
2	+5V 210 mA Maximum
3	RXD RS-232 Input
4	TXD RS-232 Output
5	RTS RS-232 Output
6	GND Logic Ground

P3-550 CPU Module - Communications

Port Specifications

RS-485 Port

A 3-pin removable terminal block used for:

- Modbus RTU Master connections
- Modbus RTU Slave connections
- ASCII Incoming and Outgoing communications
- Custom Protocol Incoming and Outgoing communications

Removable connector included. Spare connectors available (part no. P3-RS485CON).

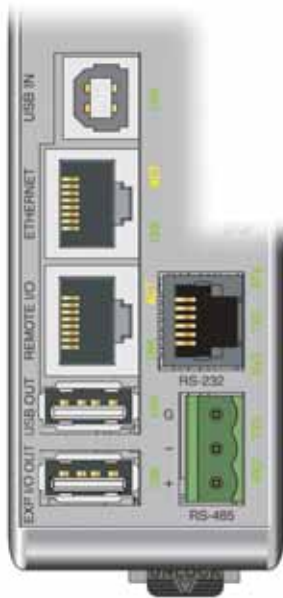

RS-485 Port Specifications	
Port Name	RS-485
Description	Non-isolated RS-485 port connects the CPU as a Modbus/ASCII master or slave to a peripheral device. Includes ESD/EFT protection and automatic echo cancellation when transmitter is active.
Data Rates	Selectable, 1200, 2400, 9600, 19200, 33600, 38400, 57600, and 115200.
TXD+/RXD+	RS-485 transceiver high
TXD-/RXD-	RS-485 transceiver low
GND	Logic ground
Input Impedance	19K Ω
Maximum load	50 transceivers, 19K Ω each, 60 Ω termination
Output Short Circuit Protection	+/- 250mA, thermal shut-down protection
Electrostatic Discharge Protection	+/-8KV per IEC1000-4-2
Electrical Fast Transient Protection	+/-2KV per IEC1000-4-4.
Minimum Differential Output Voltage	1.5V with 60 Ω load
Fail safe inputs	Logic high input state if inputs are unconnected
Maximum Common Mode Voltage	-7.5V to 12.5V.
Port Status LED	Green LED illuminated when active for TXD and RXD
Cable Options	Recommend Belden #9841 or equivalent

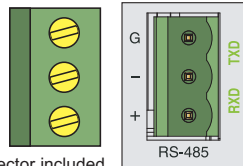

Pin #	Signal
G	GND
-	TXD-/RXD-
+	TXD+/RXD+

Removable connector included. Spare connectors available (part no. P3-RS485CON).