

ProductivityCODESYS Overview

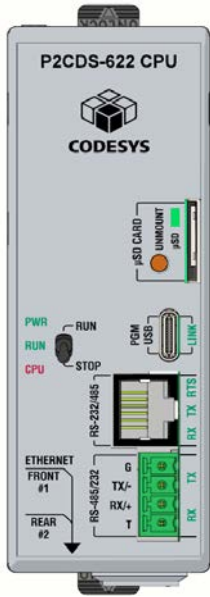

The ProductivityCODESYS platform provides IEC 61131-3 applications support when selecting coding choices for designing a control system. EtherNet/IP and Modbus TCP fieldbuses are supported when using the [P2CDS-622](#) CPU.

In addition, the CODESYS Development System includes a generic configurator for other bus systems beyond Fieldbus. These add-ons work in conjunction with CODESYS.

The CODESYS website is your main contact for the latest version of CODESYS and all add-ons.

Find the CODESYS website here:

<https://www.codesys.com/>

P2CDS-622 CPU Supports IEC 61131-3 Editor Types

- Functional Block Diagram (FBD)
- Structured Text (ST)
- Sequential Function Charts (SFC)
- Ladder Diagram (LD)

CODESYS (and P2CDS-622) also supports Continuous Function Charts (CFC) programming, in addition to the aforementioned IEC61131-3 programming types.

P2CDS-622 CPU operates within a Productivity2000 system and supports most Productivity I/O modules. Configure your system by selecting the applicable base size (4, 7, 11, or 15 slot), an appropriate power supply and any necessary I/O modules listed on following pages.

P2CDS-622

- 1. Select and order your Productivity2000 base.**



Productivity2000 Bases	
Part Number	Description
<u>P2-04B</u>	4-slot base
<u>P2-07B</u>	7-slot base
<u>P2-11B</u>	11-slot base
<u>P2-15B</u>	15-slot base

- 2. Select one of the four available Productivity2000 power supplies.**



Productivity2000 Power Supplies	
Part Number	Description
<u>P2-01DC</u>	Power supply (24-48 VDC source)
<u>P2-02DC</u>	Power supply (24VDC source)
<u>P2-01AC</u>	Power supply (100-240 VAC or 125VDC source)
<u>P2-01DCAC</u>	Power supply (24VAC or 12-24 VDC source)

- 3. Select your required I/O module(s) from a variety of Productivity2000 I/O modules on the following pages.**

P2CDS-622 System I/O Modules

A variety of discrete and analog I/O modules, as well as the P2-04PWM module from our Productivity®2000 line are available for use with the P2CDS-622 CPU.

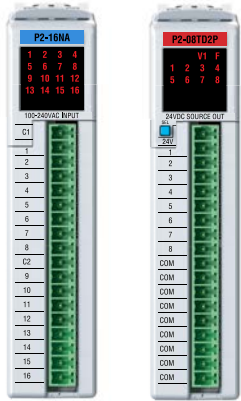

Discrete I/O Modules

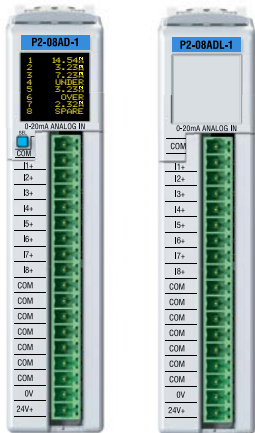

Analog Input Modules

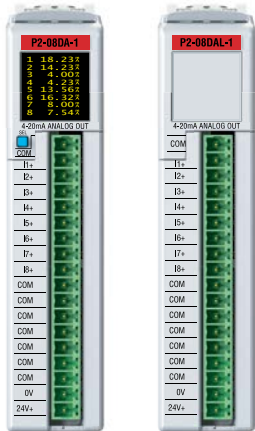

Analog Output Modules

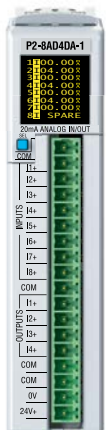

Combination Analog I/O Modules

Productivity®2000 I/O Modules Supported

Part Number	Number of Points	Description	Part Number	Number of Points	Description
Discrete Input Modules			Discrete Output Modules		
P2-08SIM	8	Input Simulator Module	P2-08TD1S	8	Isolated Sinking
P2-08ND3-1	8	Sinking/Sourcing 12–24 VDC	P2-08TD2S	8	Isolated Sourcing
P2-16ND3-1	16	Sinking/Sourcing 12–24 VDC	P2-15TD1	15	Sinking
P2-32ND3-1	32	Sinking/Sourcing 12–24 VDC	P2-15TD2	15	Sourcing
P2-08NE3	8	Sinking/Sourcing 24V AC/DC	P2-08TD1P	8	Sinking, Protected
P2-16NE3	16	Sinking/Sourcing AC/DC	P2-08TD2P	8	Sourcing, Protected
P2-32NE3	32	Sinking/Sourcing 24V AC/DC	P2-16TD1P	16	Sinking, Protected
P2-08NAS	8	AC Isolated 100–120 VAC	P2-16TD2P	16	Sourcing, Protected
P2-16NA	16	AC Isolated 100–240 VAC	P2-32TD1P	32	Sinking, Protected
Analog Input Modules			P2-32TD2P	32	Sourcing, Protected
P2-04AD	4	Voltage/Current	P2-08TAS	8	Isolated AC
P2-04AD-1	4	Current	P2-16TA	16	AC Output
P2-04AD-2	4	Voltage	P2-08TRS	8	Isolated Relay
P2-08AD-1	8	Current	P2-16TR	16	Relay Output
P2-08AD-2	8	Voltage	Analog Output Modules		
P2-08ADL-1*	8	Current	P2-04DA	4	Voltage/Current
P2-08ADL-2*	8	Voltage	P2-04DA-1	4	Current
P2-16AD-1	16	Current	P2-04DA-2	4	Voltage
P2-16AD-2	16	Voltage	P2-04DAL-1*	4	Current
P2-16ADL-1*	16	Current	P2-04DAL-2*	4	Voltage
P2-16ADL-2*	16	Voltage	P2-08DA-1	8	Current
P2-06RTD	6	RTD Input	P2-08DA-2	8	Voltage
P2-08THM	8	Thermocouple Input	P2-08DAL-1*	8	Current
P2-08NTC	8	Thermistor Input	P2-08DAL-2*	8	Voltage
Analog Combination Modules			P2-16DA-1	16	Current
P2-08AD4DA-1	8/4	Analog Input/Output (Current)	P2-16DA-2	16	Voltage
P2-8AD4DA-2	8/4	Analog Input/Output (Voltage)	P2-16DAL-1*	16	Current
			P2-16DAL-2*	16	Voltage

Specialty Modules	
Part Number	Description
P2-04PWM	High-speed pulse-width modulation

NOTE: Unsupported Modules:

- Remote Slaves (P2-RS, P1-RX)
- High-speed modules (P2-HSO, P2-HSI, P2-02HSC)
- Serial Communication module (P2-SCM)
- PS-AMC motion controllers.

P2CDS-622 CPU Module

P2CDS-622 **\$529.00**

The P2CDS-622 CPU is a Productivity2000-series compatible CPU. This CPU utilizes all Productivity2000 I/O modules, excluding the P2-RS and P1-RX remote slaves, PS-AMC motion controllers, and the following modules: P2-HSI, P2-HSO, P2-02HSC, and P2-SCM.

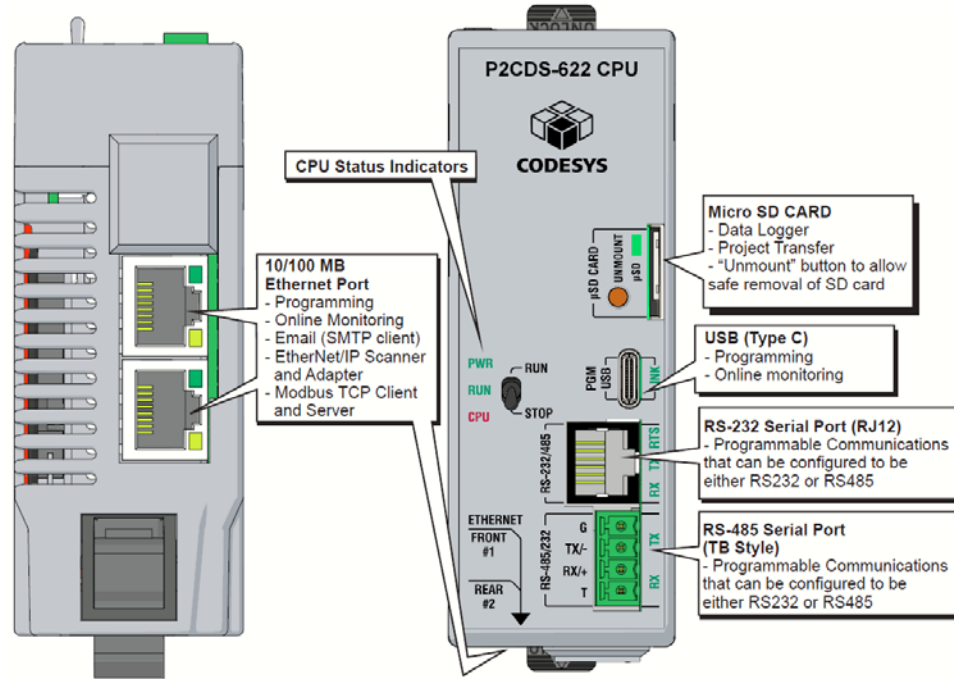

Bottom View

CPU Run/Stop Switch	
RUN position	Executes user program, run-time edits possible
STOP position	Does not execute user program, normal program load position

CPU Status Indicators	
PWR	Green LED is illuminated when power is ON
RUN	Green LED is illuminated when CPU is in RUN mode
CPU	Red LED is illuminated during power ON reset, power down, or watch-dog time-out.



P2CDS-622 RS232/485 Port

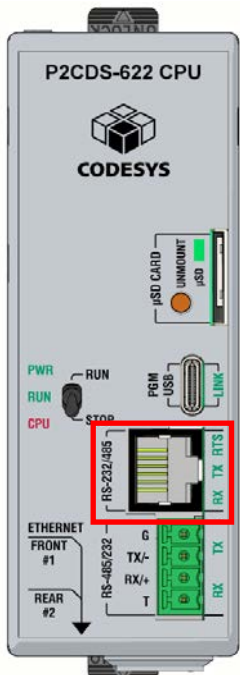

RS232/485 Port

The P2CDS-622 CPU includes an RJ12 style connector and a 4-position terminal block connector that may each be programmed for RS232 or RS485 connections. These ports may be used for:

- Modbus RTU Master connections
- Modbus RTU Slave connections
- ASCII full or half duplex communications
- Custom Protocol Incoming and Outgoing communications

RS232 Specifications	
TXD	RS232 Transmit output
RXD	RS232 Receive input
RTS	Handshaking output for modem control (RJ12 Only)
GND	Logic ground
Maximum Output Load (TXD/RTS)	3kΩ, 1000 pf
Minimum Output Voltage Swing	±5V
Output Short Circuit Protection	±15mA

RJ12 Connector Specifications	
Description	Programmable RS232/485 Port - Non-isolated RS232 DTE port connects the CPU as a Modbus/ASCII master or slave to a peripheral device. Includes ESD and built in surge protection - Non-isolated RS485 port connects the CPU as a Modbus/ASCII master or slave to a peripheral device. Includes ESD/EFT protection and automatic echo cancellation when transmitter is active
Data Rates	Selectable, 1200, 2400, 4800, 9600, 19200, 33600, 38400, 57600, and 115200
+5V Cable Power	210mA maximum at 5V, ±5%. Reverse polarity and overload protected.
Port Status LED	Green LED illuminated when active for TXD, RXD and RTS
Cable Options	EA-MG-PGM-CBL D2-DSCBL USB-RS232 with D2-DSCBL FA-CABKIT

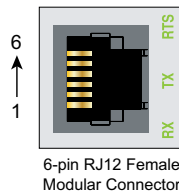

Pin #	RS232	RS485
6	GND	GND
5	RTS	
4	TXD	TXRX-
3	RXD	TXRX+
2	+5V, 210mA	Do no connect
1	GND	GND

P2CDS-622 RS485/232 Port

RS485/232 Port

A 4-pin removable terminal block used for:

- Modbus RTU Master connections
- Modbus RTU Slave connections
- ASCII Incoming and Outgoing communications
- Custom Protocol Incoming and Outgoing communications

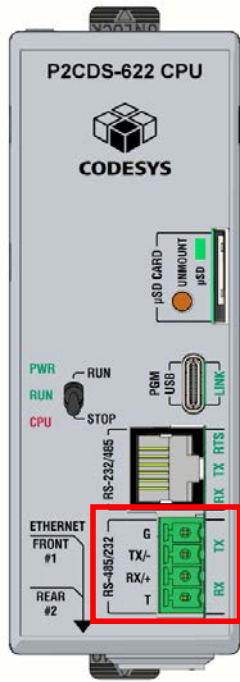

Removable connector included.
Spare connectors available
(part no. PCON-KIT)

RS485 Specifications

TXD+/RXD+	RS485 transceiver high
TXD-/RXD-	RS485 transceiver low
GND	Logic Ground
Input Impedance	19kΩ
Termination Resistance (TB Jumper wire "T" to "+")	120Ω. To use, add jumper between pin 1 and pin 2. Resistor is internally connected between pins 1 and 3.
Maximum Load	50 transceivers, 19kΩ each, 60Ω termination
Output Short Circuit Protection	±250mA, thermal shut-down protection
Electrostatic Discharge Protection	Contact ±4KV, Air ±8KV per IEC61000-4-2 (Cable is installed for testing)
Electrical Fast Transient Protection	±1KV per IEC61000-4-4
Minimum Differential Output Voltage	1.5 V with 60Ω load
Fail Safe Inputs	Logic high input state if inputs are connected
Maximum Common Mode Voltage	-7.5 V to 12.5 V

4 Position Terminal Block

Terminal Block Specifications

Description	<p>Programmable RS232/485 Port</p> <ul style="list-style-type: none"> - Non-isolated RS232 DTE port connects the CPU as a Modbus/ASCII master or slave to a peripheral device. Includes ESD and built in surge protection - Non-isolated RS485 port connects the CPU as a Modbus/ASCII master or slave to a peripheral device. Includes ESD/EFT protection and automatic echo cancellation when transmitter is active
Data Rates	Selectable, 1200, 2400, 4800, 9600, 19200, 33600, 38400, 57600, and 115200
Port Status LED	Green LED illuminated when active for TXD and RXD
Cable Options	Go to AutomationDirect.com for RS232 and RS485 cables

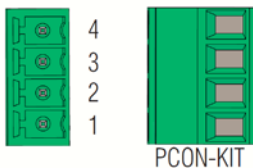

Pin #	RS232	RS485
4	GND	GND
3	TXD	TXRX-
2	RXD	TXRX+
1	Do not connect	TERMINATE

P2CDS-622 Ethernet Ports

Port Specifications

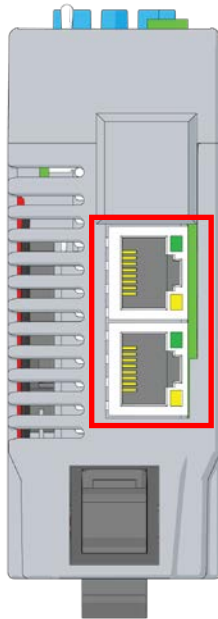

P2CDS-622
Bottom View

Ethernet Ports (On bottom of CPU)

RJ45 style connector used for:

- Connection to a PC running the programming software
- Modbus TCP Client (32 Servers) connections (Modbus requests sent from the CPU)
- Modbus TCP Server (16 Clients) connections (Modbus requests received by the CPU)
- EtherNet/IP Scanner (32 Adapters)
- EtherNet/IP Adapter (4 scanners) with 8 connections per device
- Outgoing E-mail
- MQTT Client (4 brokers)
- The rear/second multipurpose ethernet port does not have Default Gateway or DNS capability

Ethernet Specifications	
Port Name	ETHERNET
Description	Standard transformer isolated Ethernet port with built-in surge protection for programming, online monitoring, firmware, MQTT, Email (SMTP client), Modbus/TCP client/server connections (fixed IP or DHCP) and EtherNet/IP Scanner/Adapter connections.
Transfer Rate	RJ45 Yellow LED Off = 10Mbps / On = 100 Mbps
Port Status LED	RJ45 Green LED Solid when network LINK is established. Flashes when port is active (ACT).

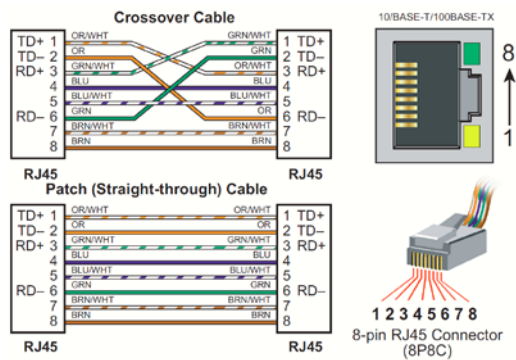

P2CDS-622 USB C Port

Port Specifications

P2CDS-622

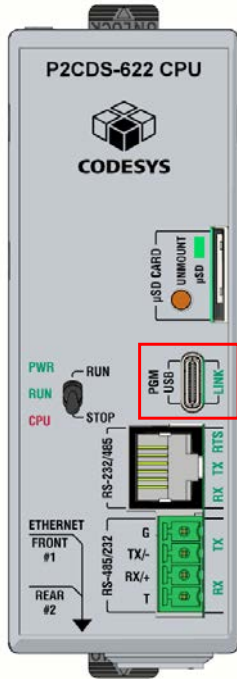

USB C Port

Used exclusively for connecting to a PC running CODESYS programming software.

USB C Specifications	
Port Name	PGM USB
Description	Standard USB C Slave input for programming and online monitoring, with built-in surge protection.
Transfer Rate	480 Mbps
Port Status LED	Green LED is illuminated when LINK is established to programming software.
Cables	USB Type A to USB Type C: 6ft cable part # USB-CBL-AC6

P2CDS-622 Module Installation

CPU Installation

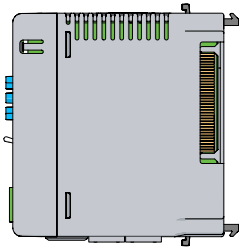

Step One:
Unlock both locking tabs

WARNING: Do not apply field power until the following steps are completed.

Step Two:
Seat CPU on support platform and push towards base until circuit board is fully engaged into connector

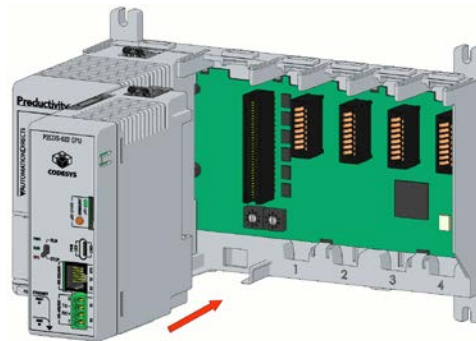

Step Three:
Snap retaining tab into the locked position.

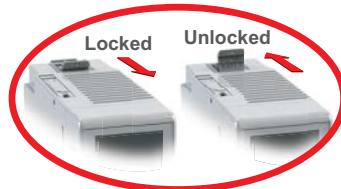

WARNING: Explosion hazard – Do not connect or disconnect or operate switches while circuit is live unless the area is known to be non-hazardous. Do not hot-swap modules unless the area is known to be non-hazardous.

P2CDS-622 CPU Module Accessories

D2-BAT-1 \$6.50

Battery (Replacement)

P2CDS-622 CPU has a battery compartment located on the top of the CPU. A battery is shipped with the CPU, but is not installed. The battery can be installed to retain the time and date along with any Tagname values that are set up as retentive. The battery is not needed for program backup.

Battery (Optional)

D2-BAT-1	Coin type, 3.0 V Lithium battery, 560mA, battery number CR2354
----------	--

Note: Although not needed for program backup, a battery may be included with some CPUs. Install this battery if you want the CPU to retain the time and date along with any Tagname values that you have set up as retentive.

Step One:

Press spring lock and swing battery compartment away from CPU.

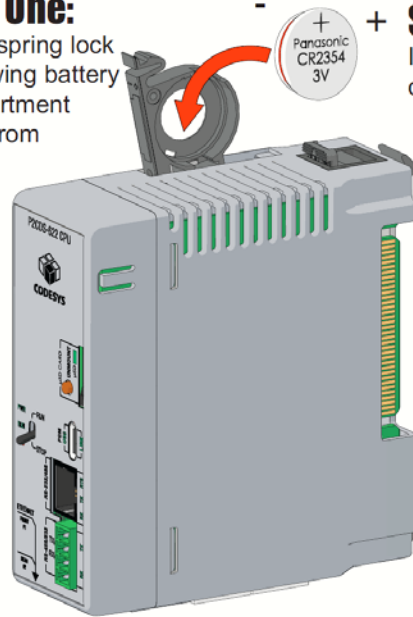

Step Two:

Insert battery and close compartment.



Take care to insert battery behind metal tab.

MICSD-16G \$39.00

microSD Card

P2CDS-622 CPU supports data logging or project transfers when employing up to a 32G microSD card. The card can be inserted in the microSD slot located on the right front face of CPU. AutomationDirect offers the MICSD-16G card that can store up to 16 gigabytes of data.

Micro SD Specifications*				
Description	Standard microSD Card for data logging or project transfer. Supports wear leveling to maximize data endurance.			
Maximum Card Capacity	32GB			
Transfer Rate (ADATA microSDHC Class 4 memory card)	Mbps	Minimum	Typical	Maximum
	Read	14.3	14.4	14.6
	Write	4.8	4.9	5.1
Operating Temperature	-25 to 85°C (-13 to 185°F)			
Speed Class	Class 4 (4 Mbps)			
Port Status LED	Green LED is illuminated when card is inserted/detected			

*Note: Card not included with unit.

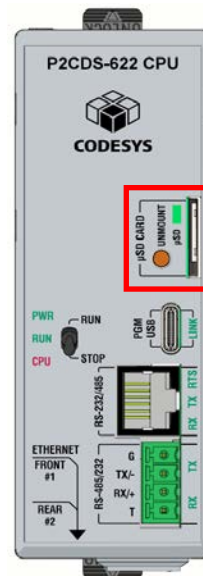

P2CDS-622 CPU