

# DC Input Modules

P2-15CDD2

\$135.00

## Discrete Input/Output

The P2-15CDD2 DC Input/Output Module provides eight 12-24 VDC inputs plus seven outputs that sink up to 2A per output for loads connected to 12-24 VDC supplies for use with the Productivity2000 System.

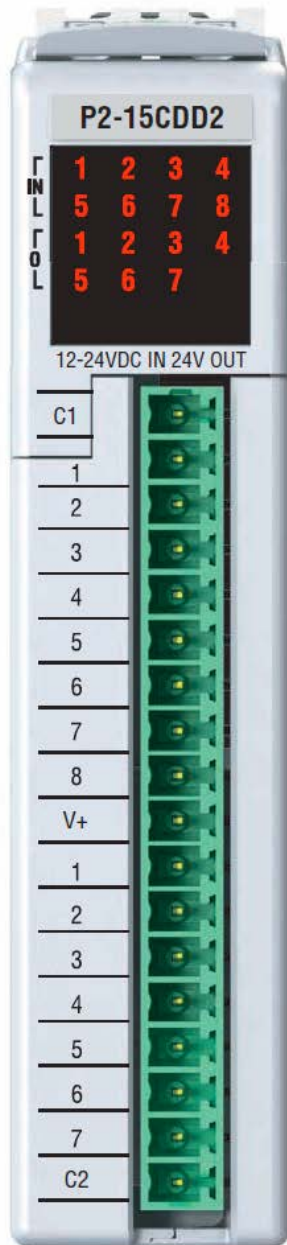

Terminal blocks sold separately.

Input Specifications	
<b>Inputs per Module</b>	8 (sink / source)
<b>Operating Voltage Range</b>	12-24 VDC
<b>Input Voltage Range</b>	10.2-26.4 VDC, max 30 VDC
<b>Input Current (typical)</b>	8.4 mA @ 24 VDC
<b>Maximum Input Current</b>	10 mA @ 26.4 VDC
<b>Input Impedance</b>	3 kΩ
<b>ON Voltage Level</b>	> 9 VDC
<b>OFF Voltage Level</b>	< 4.5 VDC
<b>Minimum ON Current</b>	1.4 mA
<b>Maximum OFF Current</b>	1 mA
<b>OFF to ON, ON to OFF Response</b>	2 ms max, 1 ms typical
<b>Status Indicators</b>	Logic side (8 points)
<b>Commons per Module</b>	1 (8 points/common)

Output Specifications	
<b>Outputs per Module</b>	7 sourcing
<b>Output Type</b>	P-channel MOSFET, open drain
<b>Rated Voltage</b>	12-24 VDC
<b>Operating Voltage Range</b>	10.2-28.48 VDC, max 30 VDC
<b>Maximum Output Current</b>	1A per point / 7A per common @ 60 °C 2A per point / 8A per common @ 55 °C
<b>Minimum Load Current</b>	1 mA
<b>Maximum Leakage Current</b>	0.3 mA @ 26.4 VDC
<b>On Voltage Drop</b>	0.3 VDC @ 1A 0.4 VDC @ 2A
<b>Maximum Inrush Current</b>	4A for 50 ms, 6A for 10 ms
<b>OFF to ON, ON to OFF Response</b>	≤ 0.5 ms
<b>Status Indicators</b>	Logic Side (7 points)
<b>Commons</b>	1 (7 points/common)
<b>Protection Circuit</b>	Not built into module - Install protection elements such as external fuse - 8A
<b>External Power Supply Required</b>	12-24 VDC (-15% / +20%) @ 22 mA

1. See Temperature Derating Charts for Outputs.

P2-15CDD2 Output Derating Chart

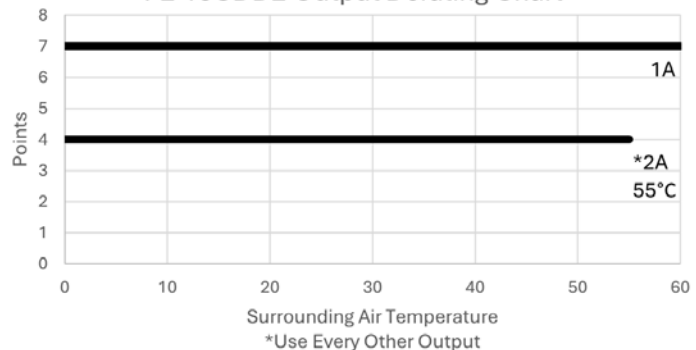

**NOTE:** The most recent Productivity Suite software and firmware versions may be required to support new modules and new features.

We recommend using pre-wired ZIPLink cables and connection modules. See Wire & Cable Termination. If you wish to hand-wire your module, removable terminal blocks are sold separately. Order part number P2-RTB or P2-RTB-1



# DC Input Modules

## P2-15CDD2 (cont'd)

General Specifications	
<b>Operating Temperature</b>	0 to 60 °C [32 to 140 °F]
<b>Storage Temperature</b>	-20 to +70 °C [-4 to +158 °F]
<b>Humidity</b>	5 to 95% (non-condensing)
<b>Altitude</b>	2000m max.
<b>Pollution Degree</b>	2
<b>Environmental Air</b>	No corrosive gases permitted
<b>Vibration</b>	IEC60068-2-6 (Test Fc)
<b>Shock</b>	IEC60068-2-27 (Test Ea)
<b>Overvoltage Category</b>	II
<b>Field to Logic Side Isolation</b>	1250 VAC applied for 5s 300 VAC applied for 1 minute
<b>Insulation Resistance</b>	>10 MΩ @ 500 VDC
<b>Heat Dissipation</b>	4550 mW
<b>Enclosure Type</b>	Open equipment
<b>Module Keying to Backplane</b>	Electronic
<b>Module Location</b>	Any I/O slot in any local base in a Productivity2000 system.
<b>Field Wiring</b>	Use <b>ZIPLink</b> wiring system or removable terminal block (sold separately). See Wire & Cable Termination.
<b>Connector Type (Sold separately)</b>	18-position removable terminal block
<b>Weight</b>	3.4 oz [97g]
<b>Agency Approvals**</b>	UL 61010-1 and UL 61010-2-201 File E139594, Canada and USA CE (EN 61131-2 EMC, EN 61010-1 and EN 61010-2-201 Safety)*

\*Meets EMC and Safety requirements. See the Declaration of Conformity for details.  
\*\*To obtain the most current agency approval information, see the Agency Approval Checklist section on the specific component part number web page.

Removable Terminal Block Specifications		
Part Number	P2-RTB	P2-RTB-1
<b>Number of positions</b>	18 screw terminals	18 spring-clamp terminals
<b>Wire Range</b>	30–16 AWG [0.051–1.31 mm <sup>2</sup> ] Solid/stranded conductor 3/64in [1.2mm] insulation max. 1/4in [6–7mm] strip length	28–16 AWG [0.081–1.31 mm <sup>2</sup> ] Solid/stranded conductor 3/64in [1.2mm] insulation max. 19/64in [7–8mm] strip length
<b>Conductors</b>	USE COPPER CONDUCTORS, 75 °C or equivalent.	
<b>Screw Driver Width</b>	0.1in. [2.5mm] maximum*	N/A
<b>Screw Size</b>	M2	N/A
<b>Screw Torque</b>	2.5 lb·in [0.28 N·m]	N/A

\* Recommended screw driver: P/N TW-SD-MSL-1.

## Wiring Diagrams

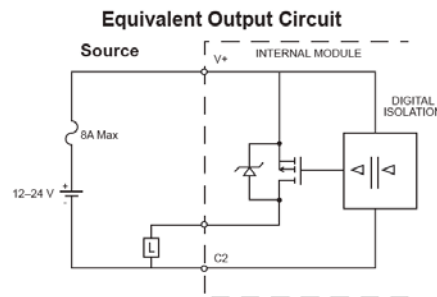
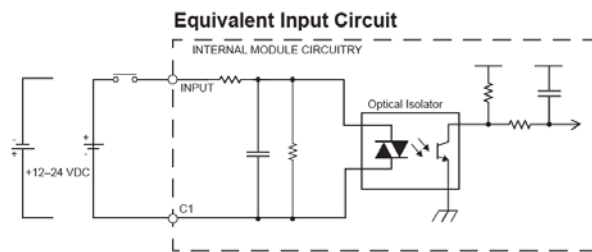
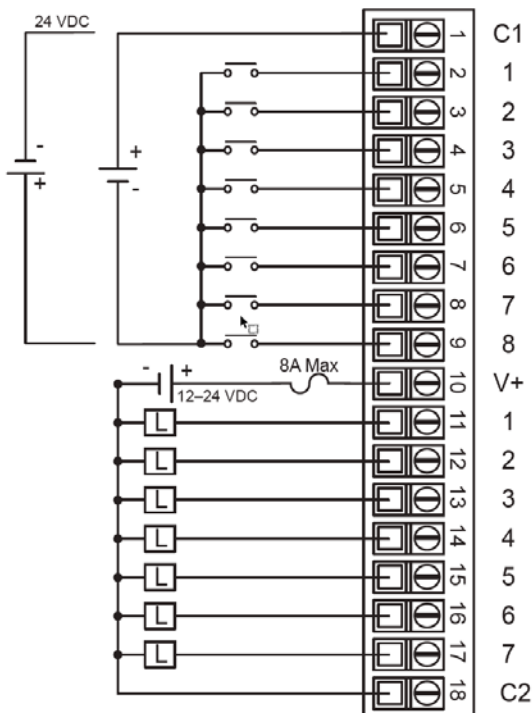

# Wiring I/O Modules

## Wiring Methods

There are two available methods for wiring most I/O modules: The ZIPLink wiring system (See page following), or hand wiring to the optional Removable Terminal Blocks.



## Removable Terminal Blocks

For most I/O modules you can purchase a removable terminal block (p/n shown below).

**Note:** Thermocouple and RTD modules are not compatible with the ZIPLink system and are shipped with the optional terminal blocks included.

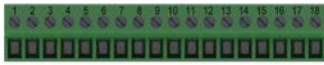

Removable Terminal Block: p/n [P2-RTB](#)

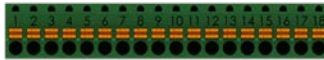

Removable Terminal Block: p/n [P2-RTB-1](#)

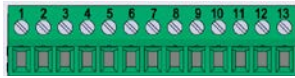

Removable Terminal Block: p/n [P2-RTB13](#)

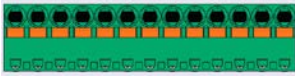

Removable Terminal Block: p/n [P2-RTB13-1](#)

Removable Terminal Block Specifications		
Part Number	<a href="#">P2-RTB</a>	<a href="#">P2-RTB-1</a>
<b>Price</b>	\$10.00	\$10.00
<b>Number of positions</b>	18 screw terminals	18 push release terminals
<b>Wire Range</b>	30–16 AWG [0.051–1.31 mm <sup>2</sup> ] Solid/stranded conductor 3/64in [1.2mm] insulation max. 1/4in [6–7mm] strip length	28–16 AWG [0.081–1.31 mm <sup>2</sup> ] Solid/stranded conductor 3/64in [1.2mm] insulation max. 19/64in [7–8mm] strip length
<b>Conductors</b>	USE COPPER CONDUCTORS, 75 °C or equivalent.	
<b>Screw Driver Width</b>	0.1 in. [2.5mm] maximum	N/A
<b>Screw Size</b>	M2	N/A
<b>Screw Torque</b>	2.5 lb·in [0.28 N·m]	N/A

\* Recommended screw driver: P/N [TW-SD-MSL-1](#).

Removable Terminal Block Specifications		
Part Number	<a href="#">P2-RTB13</a>	<a href="#">P2-RTB13-1</a>
<b>Price</b>	\$11.50	\$11.50
<b>Number of positions</b>	13 screw terminals	13 push release terminals
<b>Wire Range</b>	24–12 AWG [0.25–4 mm <sup>2</sup> ] Solid/stranded conductor 3/64in [1.2mm] insulation max. 3/8in [9–10mm] strip length	
<b>Conductors</b>	USE COPPER CONDUCTORS, 75 °C or equivalent.	
<b>Screw Driver Width</b>	0.13in [3.5mm] maximum	N/A
<b>Screw Size</b>	M2.5	N/A
<b>Screw Torque</b>	4.4 lb·in [0.5 N·m]	N/A

\* Recommended screw driver: P/N [TW-SD-MSL-1](#).

## Terminal Block Removal

Removable Terminal Blocks fit firmly into the I/O module terminal recess. To remove, firmly grasp the removable terminal block and wiggle side to side while pulling away from the module.





# Wiring Solutions

## Wiring Solutions using the ZIPLink wiring system

ZIPLinks eliminate the normally tedious process of wiring between devices by utilizing prewired cables and DIN rail mount connector modules. It's as simple as plugging in a cable connector at either end and terminating wires at only one end. Prewired cables keep installation clean and efficient, using half the space at a fraction of the cost of standard terminal blocks. There are several wiring solutions available when using the ZIPLink System ranging from CPU

### **Solution 1: DirectLOGIC, CLICK, Productivity® 1000, Productivity® 2000 and Productivity3000® I/O Modules to ZIPLink Connector Modules**

When looking for quick and easy I/O-to-field termination, a ZIPLink connector module used in conjunction with a prewired ZIPLink cable, consisting of an I/O terminal block at one end and a multi-pin connector at the other end, is the best solution.



### **Solution 2: DirectLOGIC, CLICK, Productivity1000, Productivity2000 and Productivity3000 I/O Modules to 3rd Party Devices**

When wanting to connect I/O to another device within close proximity of the I/O modules, no extra terminal blocks are necessary when using the ZIPLink Pigtail Cables. ZIPLink Pigtail Cables are prewired to an I/O terminal block with color-coded pigtail with soldered-tip wires on the other end.



### **Solution 3: GS Series and DuraPulse Drives Communication Cables**

Need to communicate via Modbus RTU to a drive or a network of drives?

ZIPLink cables are available in a wide range of configurations for connecting to CPUs, SureServo, SureStep, Stellar Soft Starter and AC drives. Add a ZIPLink communications module to quickly and easily set up a multi-device network.

I/O-to-ZIPLink Connector Modules that are ready for field termination, options for connecting to third party devices, GS Series, DuraPulse and SureServo Drives, and specialty relay, transorb and communications modules. Pre-printed I/O-specific adhesive label strips for quick marking of ZIPLink modules are provided with ZIPLink cables. See the following solutions to help determine the best ZIPLink system for your application.

Use the CPU I/O Modules to ZIPLink Connector Modules selector tables located in the ZIPLink Wiring Solutions section to:

1. Locate your I/O module/CPU,
2. Select a ZIPLink Module, and
3. Select a corresponding ZIPLink Cable.

Use the I/O Modules to 3rd Party Devices selector tables located in the ZIPLink Wiring Solutions section to:

1. Locate your CPU I/O module, and
2. Select a ZIPLink Pigtail Cable that is compatible with your 3rd party device.

Use the Drives Communication selector tables located in the ZIPLink Wiring Solutions section to:

1. Locate your Drive and type of communications, and
2. Select a ZIPLink cable and other associated hardware.





# Wiring Solutions

## **Solution 4: Serial Communications Cables**

ZIPLink offers communications cables for use with DirectLOGIC, CLICK, Productivity1000, Productivity2000 and Productivity3000 CPUs, that can also be used with other communications devices. Connections include a 6-pin RJ12 or 9-pin, 15-pin and 25-pin D-Sub connectors which can be used in conjunction with the RJ12 or D-Sub Feedthrough modules.

Using the Serial Communications Cables selector table located in the ZIPLink Wiring Solutions section,

1. Locate your connector type
2. Select a cable.



## **Solution 5: Specialty ZIPLink Modules**

For additional application solutions, ZIPLink Specialty Modules are available in a variety of configurations including stand-alone relays, 24 VDC and 120 VAC transorb modules, D-Sub, RJ12 and RJ45 feedthrough modules, communication port adapter and distribution modules, and SureServo 50-pin I/O interface connection.

Using the ZIPLink Specialty Modules selector table located in the ZIPLink Wiring Solutions section:

1. Locate the type of application.
2. Select a ZIPLink module.



## **Solution 6: ZIPLink Connector Modules to 3rd Party Devices**

If you need a way to connect your device to terminal blocks without all that wiring time, then our pigtail cables with color-coded soldered-tip wires are a good solution. Used in conjunction with any compatible ZIPLink Connector Modules, a pigtail cable keeps wiring clean and easy and reduces troubleshooting time.

Use the Universal Connector Modules and Pigtail Cables table located in the ZIPLink Wiring Solutions section to:

1. Select module type,
2. Select the number of pins
3. Select cable.





# I/O Modules to ZIPLink Connector Modules - Productivity2000

## Discrete Input Modules

Productivity2000 Input Module ZIPLink Selector				
I/O Input Module	ZIPLink Parameters			
	# of Terms	Component	Part No.	Cable Part No.
P2-08ND3-1	18	Feedthrough	ZL-RTB20 (-1)	ZL-P2-CBL18 *
P2-16ND3-1	18	Sensor/LED	ZL-LTB16-24-1	
P2-16ND-TTL	18	Feedthrough	ZL-RTB20 (-1)	
P2-08NE3				
P2-16NE3				
P2-32ND3-1	40	Feedthrough	ZL-RTB40 (-1)	ZL-CBL40 *
		Sensor/LED	ZL-LTB32-24-1	
P2-32NE3	40	Feedthrough	ZL-RTB40 (-1)	ZL-P2-CBL18 *
P2-08NAS	18	Feedthrough	ZL-RTB20 (-1)	
P2-16NA	18			

## Discrete Output Modules

Productivity2000 Output Module ZIPLink Selector					
I/O Output Module	ZIPLink Parameters				
	# of Terms	Component	Part No.	Cable Part No.	
P2-08TD1S	18	Feedthrough	ZL-RTB20 (-1)	ZL-P2-CBL18 *	
P2-08TD2S	18				
P2-15TD1	18				
P2-15TD2	18				
P2-08TD1P	18				
P2-16TD-TTL	18				
P2-08TD2P	18				
P2-08TRS	18				
P2-08TEPS	18				
P2-16TEP	18				
P2-08TAS	18				
P2-16TA	18				Feedthrough
		Fuse	ZL-RFU20 <sup>2</sup>		
P2-16TD1P	18	Feedthrough	ZL-RTB20 (-1)		
		Relay (Sinking)	ZL-RRL16-24-1 ZL-RRL16W-24-1 ZL-RRL16F-24-1		
		Relay (Sourcing)	ZL-RRL16-24-2 ZL-RRL16W-24-2 ZL-RRL16F-24-2		
P2-16TD2P	18	Feedthrough	ZL-RTB20 (-1)		
		Relay (Sourcing)	ZL-RRL16-24-2 ZL-RRL16W-24-2 ZL-RRL16F-24-2		
P2-32TD1P	40	Feedthrough	ZL-RTB40 (-1)	ZL-CBL40 *	
P2-32TD2P	40				
P2-16TR	18	Feedthrough	ZL-RTB20 (-1)	ZL-P2-CBL18 *	
		Fuse	ZL-RFU20 <sup>2</sup>		

## Specialty Modules

Productivity2000 Specialty & Motion Modules ZIPLink Selector				
I/O Module	ZIPLink Parameters			
	# of Terms	Component	Part No.	Cable Part No.
P2-HSI	40	Feedthrough	ZL-RTB40 (-1)	ZL-CBL40-S
P2-HSO				ZL-CBL40-1S ZL-CBL40-2S
P2-02HSC	See Note 1			
P2-04PWM	18	Feedthrough	ZL-RTB20 (-1)	ZL-P2-CBL18 *
P2-08SIM	See Note 1			
P2-SCM	See Note 1			

### Table Notes

\* Select the cable length by replacing the \* with: Blank = 0.5m, -1 = 1.0m, or -2 = 2.0m.  
 1. These modules are not supported by the ZIPLink wiring system.  
 2. Note: Fuses (5 x 20mm) are not included. See Edison Electronic Fuse section for (5 x 20mm) fuse. S500 and GMA electronic circuit protection for fast-acting maximum protection. S506 and GMC electronic circuit protection for time-delay performance. Ideal for inductive circuits.  
 To ensure proper operation, do not exceed the voltage and current rating of ZIPLink module. ZL-RFU20 = 2A per circuit; ZL-RFU40 = 400 mA per circuit.

## Discrete Combo Modules

Productivity2000 Discrete Combo Modules				
I/O Output Module	ZIPLink Parameters			
	# of Terms	Component	Part No.	Cable Part No.
P2-15CDD1	18	Feedthrough	ZL-RTB20 (-1)	ZL-P2-CBL18 *
P2-15CDD2	18			
P2-16CDR	18			



# I/O Module Installation Procedure

**WARNING: DO NOT APPLY FIELD POWER UNTIL THE FOLLOWING STEPS ARE COMPLETED. SEE HOT-SWAP PROCEDURE FOR EXCEPTIONS.**

**Step One:** Align module catch with base slot and module into connector.

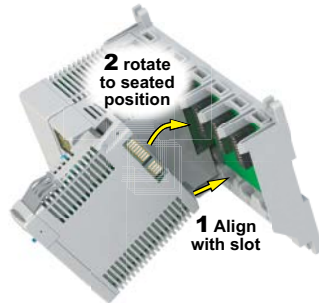

**Step Two:** Pull top locking tab toward module face. Click indicates lock is engaged.

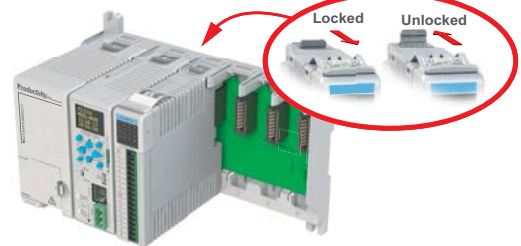

**Step Three:** Attach field wiring using removable terminal block or ZIPLink wiring system.



**WARNING: EXPLOSION HAZARD – DO NOT CONNECT OR DISCONNECT CONNECTORS OR OPERATE SWITCHES WHILE CIRCUIT IS LIVE UNLESS THE AREA IS KNOWN TO BE NON-HAZARDOUS. DO NOT HOT-SWAP MODULES UNLESS THE AREA IS KNOWN TO BE NON-HAZARDOUS.**