

Wiring Duct – T1E Thin Finger Series

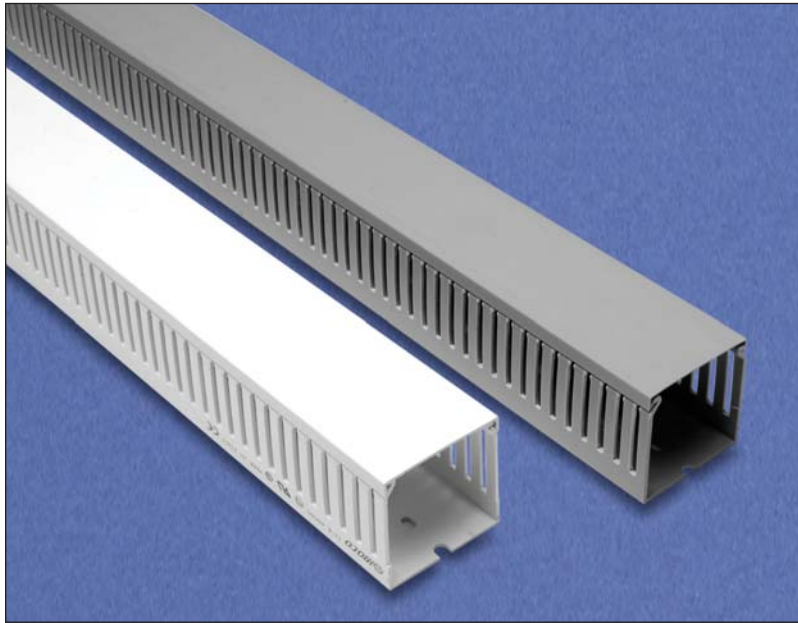

UL file E123572



Overview

The T1E series of thin-finger wiring duct is made of rigid PVC and carries a UL 94V-0 flammability rating. All our wiring duct comes complete with cover. Replacement duct covers can be purchased separately.

Features

- Thin finger design for compact wiring configurations
- Provided with standard mounting holes
- Rounded, burr-free edges will not cut installers' hands or wiring insulation
- Non-slip cover
- Narrow thin finger design is compatible with thinner screwless terminal blocks
- Flush cover design holds 10 - 12 percent more wires than traditional designs
- Restricted slot design retains wires in slot for fast, easy wire installation or removal
- Two predetermined break lines, one for breaking off and removal of sidewall finger segments only, and another for removal of sidewall finger and base segments
- Patented recess boss for rapid mounting of components

Gray Open Slot Rigid PVC (including cover)					
Catalog Number Standard Carton	Package Quantity	Price	Catalog Number Single Piece Pkg	Package Quantity	Price
T1E-1015G	18	<-->	T1E-1015G-1	1	<-->
T1E-1022G	24	<-->	T1E-1022G-1	1	<-->
T1E-1030G	24	<-->	T1E-1030G-1	1	<-->
T1E-1515G	20	<-->	T1E-1515G-1	1	<-->
T1E-1522G	18	<-->	T1E-1522G-1	1	<-->
T1E-1530G	16	<-->	T1E-1530G-1	1	<-->
T1E-1540G	8	<-->	T1E-1540G-1	1	<-->
T1E-2215G	12	<-->	T1E-2215G-1	1	<-->
T1E-2222G	12	<-->	T1E-2222G-1	1	<-->
T1E-2230G	12	<-->	T1E-2230G-1	1	<-->
T1E-2240G	4	<-->	T1E-2240G-1	1	<-->
T1E-3015G	12	<-->	T1E-3015G-1	1	<-->
T1E-3022G	12	<-->	T1E-3022G-1	1	<-->
T1E-3030G	12	<-->	T1E-3030G-1	1	<-->
T1E-3040G	4	<-->	T1E-3040G-1	1	<-->
T1E-4015G	8	<-->	T1E-4015G-1	1	<-->
T1E-4022G	8	<-->	T1E-4022G-1	1	<-->
T1E-4030G	8	<-->	T1E-4030G-1	1	<-->
T1E-4040G	4	<-->	T1E-4040G-1	1	<-->

White Open Slot Rigid PVC (including cover)					
Catalog Number Standard Carton	Package Quantity	Price	Catalog Number Single Piece Pkg	Package Quantity	Price
T1E-1015W	18	<-->	T1E-1015W-1	1	<-->
T1E-1022W	24	<-->	T1E-1022W-1	1	<-->
T1E-1030W	24	<-->	T1E-1030W-1	1	<-->
T1E-1515W	20	<-->	T1E-1515W-1	1	<-->
T1E-1522W	18	<-->	T1E-1522W-1	1	<-->
T1E-1530W	16	<-->	T1E-1530W-1	1	<-->
T1E-1540W	8	<-->	T1E-1540W-1	1	<-->
T1E-2222W	12	<-->	T1E-2222W-1	1	<-->
T1E-2230W	12	<-->	T1E-2230W-1	1	<-->
T1E-2240W	4	<-->	T1E-2240W-1	1	<-->
T1E-3022W	12	<-->	T1E-3022W-1	1	<-->
T1E-3030W	12	<-->	T1E-3030W-1	1	<-->
T1E-3040W	4	<-->	T1E-3040W-1	1	<-->
T1E-4030W	8	<-->	T1E-4030W-1	1	<-->
T1E-4040W	4	<-->	T1E-4040W-1	1	<-->

Note: All T1E duct comes in 6.56 feet (2m) lengths.

Wiring Duct – T1E Thin Finger Series

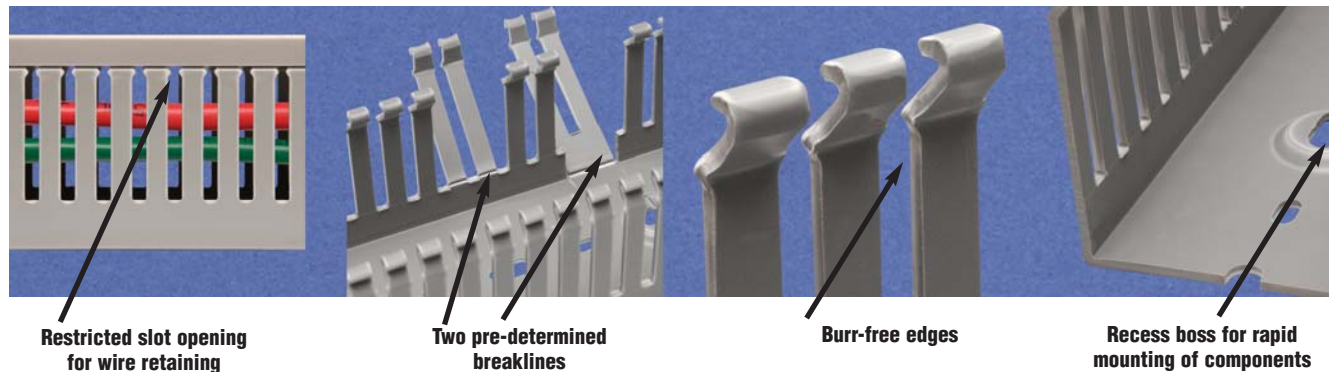

Dimensions

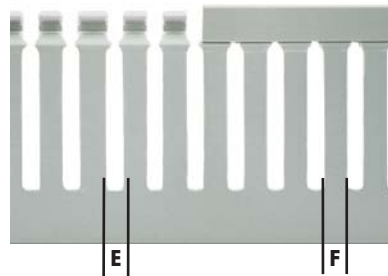
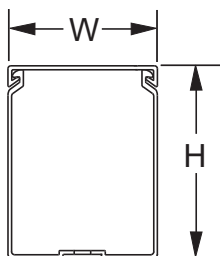

Open Slot Rigid PVC (including cover) Dimensions				
Nominal Size (WxH) inches (mm)	Catalog Part Number	Actual Size (WxH) inches (mm)	Dimension E inches (mm)	Dimension F inches (mm)
1.00 x 1.50 (25.4 x 38.1)	T1E-1015*	1.00 x 1.57 (25 x 40)	0.16 (4.06)	0.24 (6.10)
1.00 x 2.25 (25.4 x 57.15)	T1E-1022*	1.00 x 2.36 (25 x 60)	0.16 (4.06)	0.24 (6.10)
1.00 x 3.00 (25.4 x 76.2)	T1E-1030*	1.00 x 3.15 (25 x 80)	0.16 (4.06)	0.24 (6.10)
1.50 x 1.50 (38.1 x 38.1)	T1E-1515*	1.57 x 1.57 (40 x 40)	0.16 (4.06)	0.24 (6.10)
1.50 x 2.25 (38.1 x 57.15)	T1E-1522*	1.57 x 2.36 (40 x 60)	0.16 (4.06)	0.24 (6.10)
1.50 x 3.00 (38.1 x 76.2)	T1E-1530*	1.57 x 3.15 (40 x 80)	0.16 (4.06)	0.24 (6.10)
1.50 x 4.00 (38.1 x 101.6)	T1E-1540*	1.57 x 3.94 (40 x 100)	0.31 (7.87)	0.47 (11.94)
2.25 x 1.50 (57.15 x 38.1)	T1E-2215G	2.36 x 1.57 (60 x 40)	0.16 (4.06)	0.24 (6.10)
2.25 x 2.25 (57.15 x 57.15)	T1E-2222*	2.36 x 2.36 (60 x 60)	0.16 (4.06)	0.24 (6.10)
2.25 x 3.00 (57.15 x 76.2)	T1E-2230*	2.36 x 3.15 (60 x 80)	0.16 (4.06)	0.24 (6.10)
2.25 x 4.00 (57.15 x 101.6)	T1E-2240*	2.36 x 3.94 (60 x 100)	0.31 (7.87)	0.47 (11.94)
3.00 x 1.50 (76.2 x 38.1)	T1E-3015G	3.15 x 1.57 (80 x 40)	0.16 (4.06)	0.24 (6.10)
3.00 x 2.25 (76.2 x 57.15)	T1E-3022*	3.15 x 2.36 (80 x 60)	0.16 (4.06)	0.24 (6.10)
3.00 x 3.00 (76.2 x 76.2)	T1E-3030*	3.15 x 3.15 (80 x 80)	0.16 (4.06)	0.24 (6.10)
3.00 x 4.00 (76.2 x 101.6)	T1E-3040*	3.15 x 3.94 (80 x 100)	0.31 (7.87)	0.47 (11.94)
4.00 x 1.50 (101.6 x 38.1)	T1E-4015G	3.94 x 1.57 (100 x 40)	0.16 (4.06)	0.24 (6.10)
4.00 x 2.25 (101.6 x 57.15)	T1E-4022G	3.94 x 2.36 (100 x 60)	0.16 (4.06)	0.24 (6.10)
4.00 x 3.00 (101.6 x 76.2)	T1E-4030*	3.94 x 3.15 (100 x 80)	0.16 (4.06)	0.24 (6.10)
4.00 x 4.00 (101.6 x 101.6)	T1E-4040*	3.94 x 3.94 (100 x 100)	0.16 (4.06)	0.24 (6.10)

*Color: add suffix "G" for light Gray
add suffix "W" for White

Package: add "-1" for single piece package

Note: All T1E duct comes in 6.56 feet (2m) lengths.

Company Info.

PLCs

Field I/O

Software

C-more & other HMI

AC Drives

AC Motors

Power Transmiss.

Steppers/ Servos

Motor Controls

Proximity Sensors

Photo Sensors

Limit Switches

Encoders

Current Sensors

Pressure Sensors

Temp. Sensors

Pushbuttons/ Lights

Process

Relays/ Timers

Comm.

Terminal Blocks & Wiring

Power

Circuit Protection

Enclosures

Tools

Pneumatics

Appendix

Part Index

Wiring Duct – T1E Thin Finger Series

Wire Fill Capacity

Wire Fill Capacity						
Nominal Duct Size (in inches)	12 AWG	14 AWG		16AWG	18 AWG	22 AWG
	Insulation Thickness (in inches)					
	1/32	3/64	1/32	1/32	1/32	1/64
	OD-0.158	OD-0.165	OD-0.139	OD-0.125	OD-0.113	OD-0.065
Recommended Maximum Number of Wires per Wiring Duct (based on 60% fill capacity)						
1 x 1 1/2	31	28	39	48	59	180
1 x 2 1/4	45	40	57	71	85	261
1 x 3	59	53	75	92	113	341
1 1/2 x 1 1/2	51	46	65	81	99	299
1 1/2 x 2 1/4	77	70	98	121	148	449
1 1/2 x 3	102	92	130	160	196	593
1 1/2 x 4	125	113	159	197	241	729
2 1/4 x 1 1/2	78	70	99	123	150	453
2 1/4 x 2 1/4	114	103	146	180	221	667
2 1/4 x 3	156	141	199	246	302	912
2 1/4 x 4	194	176	247	306	375	1132
3 x 1 1/2	105	95	134	165	203	612
3 x 2 1/4	159	144	203	251	307	928
3 x 3	214	193	272	337	412	1246
3 x 4	267	242	341	421	515	1558
4 x 1 1/2	132	120	169	208	255	771
4 x 2 1/4	201	182	256	316	387	1171
4 x 3	270	244	344	425	520	1573
4 x 4	336	305	429	531	650	1963

Overview

The base perforation of the T1E wiring duct series allows mounting on the panel with rivets (R6 or R4), or on DIN rail.

The recess bosses in the base permit rapid mounting of wire retainers (CL series), inserts (ZP2), and separators (SEP series) inside the wiring duct.

Note: Duct base perforation according to DIN 43659 and DIN VDE 0660 TEIL 506.

Dimensions

front section

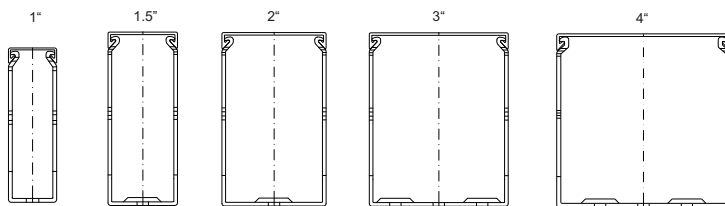

Base perforation

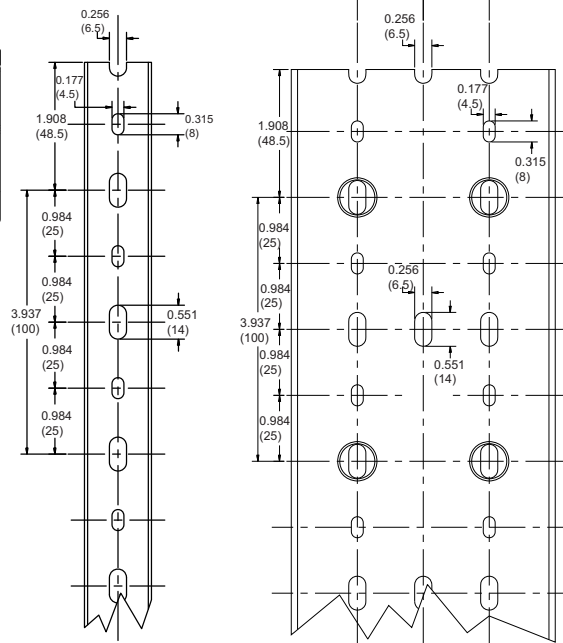

1", 1.5", 2" wide

3" and 4" wide

Wiring Duct Cover

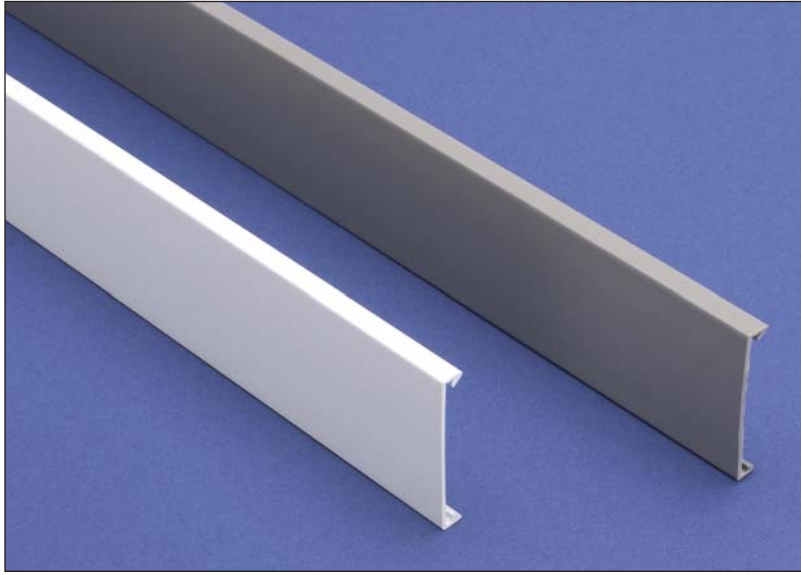

Duct Cover

Our standard wire duct products are supplied complete with covers. These replacement covers are manufactured from the same rigid self-extinguishing PVC material.

UL file E123572



Duct Cover Specifications					
Part Number	Price	Description	Color	Standard Carton	
				Pcs/Pkg	Actual Total Length ft (m)
COV-05G	<--->	Cover for 0.5" wide duct	Gray	25	164 (50)
COV-05G-1	<--->	Cover for 0.5" wide duct	Gray	1	6.56 (2)
COV-10G	<--->	Cover for 1.0" wide duct	Gray	25	164 (50)
COV-10G-1	<--->	Cover for 1.0" wide duct	Gray	1	6.56 (2)
COV-10W	<--->	Cover for 1.0" wide duct	White	25	164 (50)
COV-10W-1	<--->	Cover for 1.0" wide duct	White	1	6.56 (2)
COV-15G	<--->	Cover for 1.5" wide duct	Gray	25	164 (50)
COV-15G-1	<--->	Cover for 1.5" wide duct	Gray	1	6.56 (2)
COV-15W	<--->	Cover for 1.5" wide duct	White	25	164 (50)
COV-15W-1	<--->	Cover for 1.5" wide duct	White	1	6.56 (2)
COV-22G	<--->	Cover for 2.25" wide duct	Gray	25	164 (50)
COV-22G-1	<--->	Cover for 2.25" wide duct	Gray	1	6.56 (2)
COV-22W	<--->	Cover for 2.25" wide duct	White	25	164 (50)
COV-22W-1	<--->	Cover for 2.25" wide duct	White	1	6.56 (2)
COV-30G	<--->	Cover for 3.0" wide duct	Gray	25	164 (50)
COV-30G-1	<--->	Cover for 3.0" wide duct	Gray	1	6.56 (2)
COV-30W	<--->	Cover for 3.0" wide duct	White	25	164 (50)
COV-30W-1	<--->	Cover for 3.0" wide duct	White	1	6.56 (2)
COV-40G	<--->	Cover for 4.0" wide duct	Gray	20	131.2 (40)
COV-40G-1	<--->	Cover for 4.0" wide duct	Gray	1	6.56 (2)
COV-40W	<--->	Cover for 4.0" wide duct	White	20	131.2 (40)
COV-40W-1	<--->	Cover for 4.0" wide duct	White	1	6.56 (2)
COV-60G	<--->	Cover for 6.0" wide duct	Gray	20	131.2 (40)
COV-60G-1	<--->	Cover for 6.0" wide duct	Gray	1	6.56 (2)
COV-60W	<--->	Cover for 6.0" wide duct	White	20	131.2 (40)
COV-60W-1	<--->	Cover for 6.0" wide duct	White	1	6.56 (2)

Note: Standard length of covers is 6.56 feet (2m) to fit T1, T1E and TSH duct.

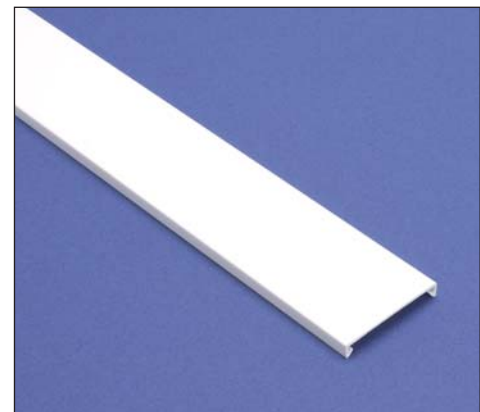
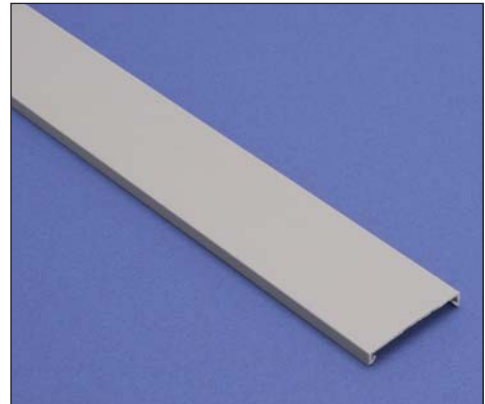

Wiring Duct – Accessories

Duct Separators

Duct separators allow the physical separation of circuits within a single piece of duct. The various mounting arrangements allow alternate compartmentalization of duct and differing ratios of usable sections.

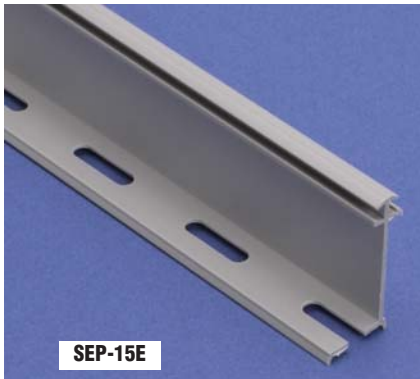

SEP-15E

Duct Separators					
Part Number	Price	Description	Color	Standard Carton	
				Pcs/Pkg	Total Actual Length ft (m)
SEP-15E	<--->	Separator for 1.5" high duct, bulk pack	Gray	32	209.92 (64)
SEP-15E-1	<--->	Separator for 1.5" high duct	Gray	1	6.56 (2)
SEP-22E	<--->	Separator for 2.25" high duct, bulk pack	Gray	20	131.20 (40)
SEP-22E-1	<--->	Separator for 2.25" high duct	Gray	1	6.56 (2)
SEP-30E	<--->	Separator for 3.0" high duct, bulk pack	Gray	12	78.72 (24)
SEP-30E-1	<--->	Separator for 3.0" high duct	Gray	1	6.56 (2)

Note: Length of separators is 6.56' (2m).

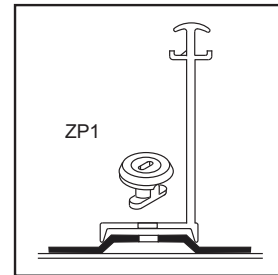

SEP-E Mounting detail
Order ZP1 mount separately

Wire Retainers

For holding wires during wiring operations, these retainers are essential. They allow easy access to the interior of the wiring duct during maintenance or alterations, while assuring that wiring bundles will not fall out when the duct cover is removed. Installed with a simple rotating movement, they anchor firmly in the recess boss in the duct base.

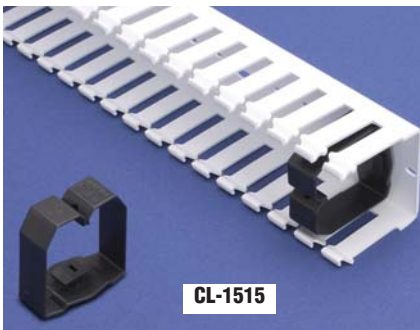

CL-1515

Wire Retainers				
Part Number	Price	Description	Color	Pcs/Pkg
CL-1515	<--->	Wire retainer fastener for 1.5" x 1.5" duct	Gray	40
CL-1522	<--->	Wire retainer fastener for 1.5" x 2.25" duct	Gray	40
CL-1530	<--->	Wire retainer fastener for 1.5" x 3.0" duct	Gray	20
CL-2215	<--->	Wire retainer fastener for 2.25" x 1.5" duct	Gray	40
CL-2222	<--->	Wire retainer fastener for 2.25" x 2.25" duct	Gray	20
CL-2230	<--->	Wire retainer fastener for 2.25" x 3.0" duct	Gray	20
CL-2240	<--->	Wire retainer fastener for 2.25" x 4.0" duct	Gray	20
CL-3022	<--->	Wire retainer fastener for 3.0" x 2.25" duct	Gray	10
CL-3030	<--->	Wire retainer fastener for 3.0" x 3.0" duct	Gray	10
CL-3040	<--->	Wire retainer fastener for 3.0" x 4.0" duct	Gray	10
CL-4015	<--->	Wire retainer fastener for 4.0" x 1.5" duct	Gray	10
CL-4022	<--->	Wire retainer fastener for 4.0" x 2.25" duct	Gray	10
CL-4030	<--->	Wire retainer fastener for 4.0" x 3.0" duct	Gray	10
CL-4040	<--->	Wire retainer fastener for 4.0" x 4.0" duct	Gray	5
CL-6040	<--->	Wire retainer fastener for 6.0" x 4.0" duct	Gray	5

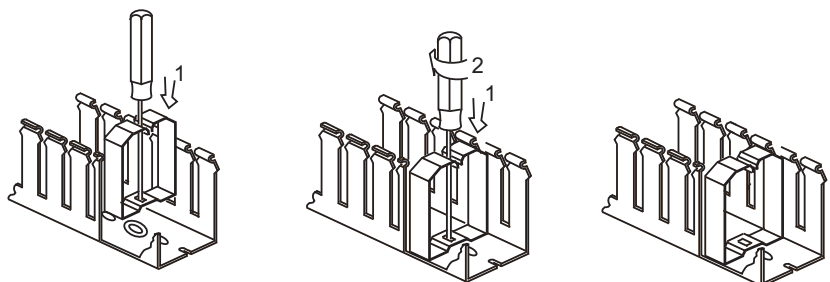
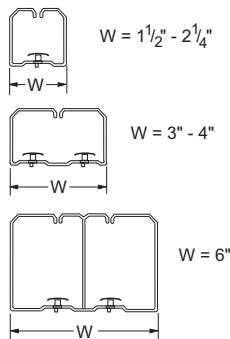

Wiring Duct – Accessories

Duct Marking Tags			
Part Number	Price	Description	Pcs/Pkg
DM1	<--->	Single-width white cardboard identification label for wiring duct. Supplied with black plastic mounting clip and transparent plastic cover slide	50

Note: DM1 marking tags can only be used with T1 series wire duct.

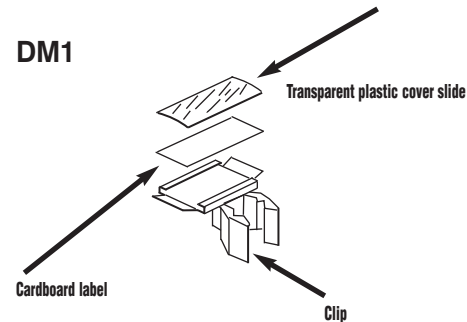

Identification Tags

Allowing easy identification of control gear and switchgear, these tags are mounted by snapping the clip onto the sidewall finger segments of the duct. No gluing - no drilling! After installation, they need not be removed during maintenance or any work which involves the removal of the covers.

Note: Take care that clip is installed above the wires coming out to the sidewall slots.

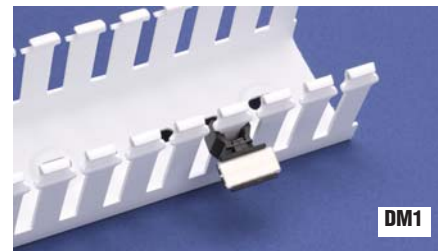

Mounting Devices			
Part Number	Price	Description	Pcs/Pkg
ZP1	<--->	Round, white polyamide 'button' used to mount components and separators inside duct.	100
ZP2	<--->	Square white polyamide cable tie mount used to tighten a wire bundle inside duct.	50

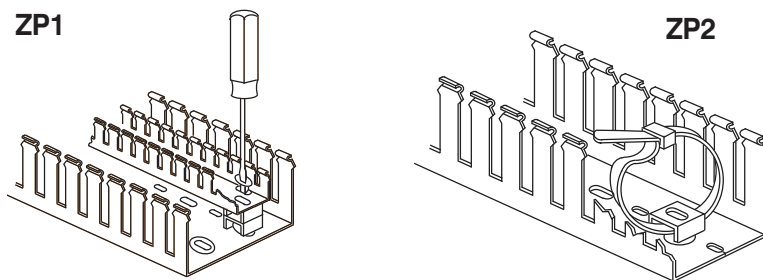

Mounting Inserts

We carry mounts in two styles: ZP1 for mounting components and SEP-E separators inside duct, or for mounting small sizes of duct inside larger sizes (for separation of circuits with different functions); and ZP2, which is used with a cable tie to secure a wire bundle inside the duct.



Wiring Duct Rivets and Rivet Tools			
Part Number	Price	Description	Pcs/Pkg
R4	<--->	Blue polyamide rivet used to install all types of wiring duct with standard 5/32" (4 mm) mounting holes.	250
B4	<--->	Red polyamide rivet tool used to install R4 rivets.	1
R6	<--->	Natural polyamide rivet used to install all types of wiring duct with standard 7/32" (5.5 mm) mounting holes.	250
B6	<--->	Yellow polyamide rivet tool used to install R6 rivets.	1

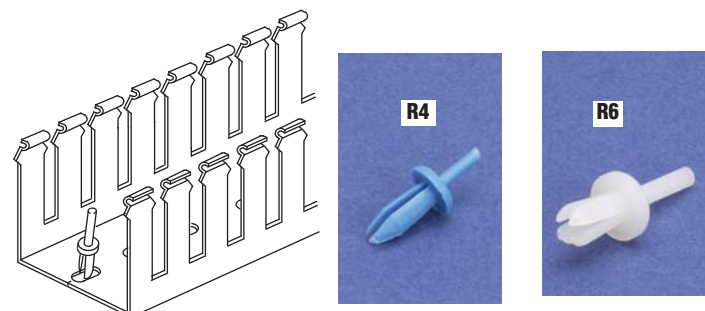

Rivets and Rivet Tools

Wiring duct rivets install quickly and easily with the companion rivet tool, offering good temperature resistance and excellent mechanical properties. They can be used to install all types of wiring duct with standard mounting holes.

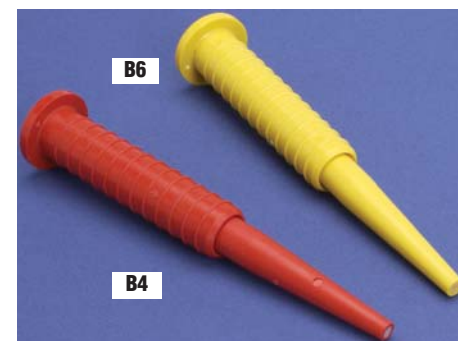

Wiring Duct – Accessories

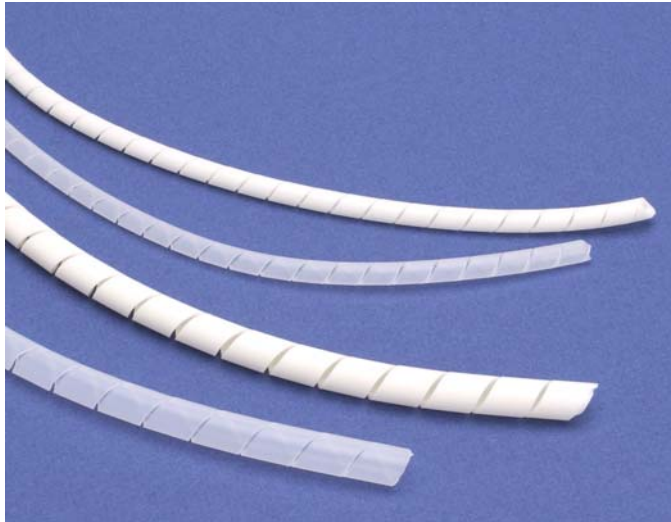

Spiral Wrap

For neatly grouping wire bundles simply and economically, spiral wrap has no equal. Strong, yet easy to install, it protects the wire bundle, keeping it flexible though tightly contained. It is easily removed and reusable for temporary wiring.

Dimensions

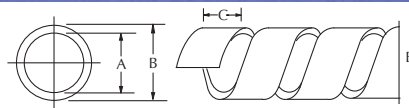

Catalog Number		Dimensions in Inches			Wire Bundle Size in Inches	Feet per Carton
Polyethylene	Flame-Retardant Polyethylene	A	B	C		
P-1	PA1	.06	.12	.20	1/16 to 1/2	160
P-2	PA2	.16	.24	.31	¼ to 2	80
P-3	PA3	.31	.39	.47	3/8 to 3	80
P-4	PA4	.35	.47	.47	½ to 4	65

Spiral Wrap				
Part Number	Price	Description	Color	Length
P-1	<-->	0.125" nominal o.d. Polyethylene spiral wrap used for wire bundles from 1/16 to 1/2 inch diameter.	Natural	160 ft./pack
PA1	<-->	0.125" nominal o.d. self-extinguishing Polyethylene spiral wrap used for wire bundles from 1/16 to 1/2 inch diameter.	White	160 ft./pack
P-2	<-->	0.25" nominal o.d. Polyethylene spiral wrap used for wire bundles from 1/4 to 2 inch diameter.	Natural	80 ft./pack
PA2	<-->	0.25" nominal o.d. self-extinguishing Polyethylene spiral wrap used for wire bundles from 1/4 to 2 inch diameter.	White	80 ft./pack
P-3	<-->	0.375" nominal o.d. Polyethylene spiral wrap used for wire bundles from 3/8 to 3 inch diameter.	Natural	80 ft./pack
PA3	<-->	0.375" nominal o.d. self-extinguishing Polyethylene spiral wrap used for wire bundles from 3/8 to 3 inch diameter.	White	80 ft./pack
P-4	<-->	0.5" nominal o.d. Polyethylene spiral wrap used for wire bundles from 1/2 to 4 inch diameter.	Natural	65 ft./pack
PA4	<-->	0.5" nominal o.d. self-extinguishing Polyethylene spiral wrap used for wire bundles from 1/2 to 4 inch diameter.	White	65 ft./pack

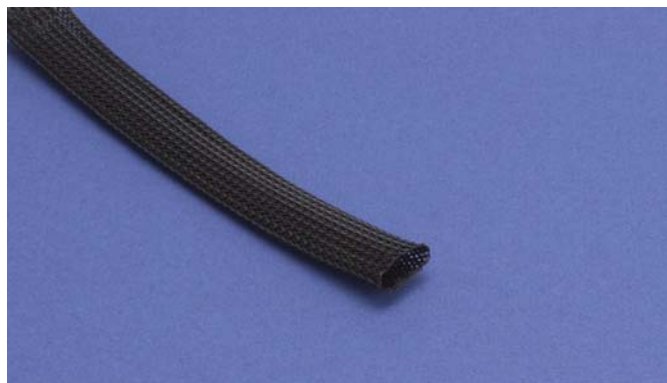

Braided Sleeving

This lightweight, expandable, self-extinguishing polyester sleeving has an open weave to allow maximum diameter expansion. It is super-flexible and easy to install, gripping objects of various shapes and sizes reliably. Abrasion-resistant, it provides extra protection against chemicals and flame.

Braided Expandable Sleeving Material Specifications	
Operating Temp	-50°C to +150°C (-58°F to +302°F)
Physical Properties	Self-extinguishing for UL 94V-2
Maximum Elongation	42%
Diameter Expansion	100%
Other	Halogen-free

Expandable Sleeving				
Part Number	Price	Description	Color	Length
TY-5	<-->	Braided expandable polyester sleeving, 0.197" (5mm) nominal i.d., 0.157" (4mm) to 0.472" (12mm) nominal range	Black	325 ft./pack
TY-10	<-->	Braided expandable polyester sleeving, 0.375" (10mm) nominal i.d., 0.315" (8mm) to 0.866" (22mm) nominal range	Black	325 ft./pack
TY-20	<-->	Braided expandable polyester sleeving, 0.750" (20mm) nominal i.d., 0.630" (16mm) to 1.378" (35mm) nominal range	Black	164 ft./pack
TY-30	<-->	Braided expandable polyester sleeving, 1.125" (30mm) nominal i.d., 0.984" (25mm) to 1.890" (48mm) nominal range	Black	164 ft./pack
TY-50	<-->	Braided expandable polyester sleeving, 2.0" (50mm) nominal i.d., 1.575" (40mm) to 2.825" (72mm) nominal range	Black	164 ft./pack

Wiring Duct – Material Specifications

Company Info.
PLCs
Field I/O
Software
C-more & other HMI
AC Drives
AC Motors
Power Transmiss.
Steppers/ Servos
Motor Controls
Proximity Sensors
Photo Sensors
Limit Switches
Encoders
Current Sensors
Pressure Sensors
Temp. Sensors
Pushbuttons/ Lights
Process
Relays/ Timers
Comm.
Terminal Blocks & Wiring
Power
Circuit Protection
Enclosures
Tools
Pneumatics
Appendix
Part Index

Material Specifications								
Materials	Test Standard	Unit of Measure	Rigid PVC	Polypropylene	PVC Molded Components	Polyamide 6	Polyethylene	Flame Retardant Polyethylene
Technical Characteristics								
Chemical/Physical Properties								
Specific Gravity	ASTM D792	g/cm ³	1.55	1.01	1.32	1.14	0.92	0.97
H₂O 73.4°F Absorption	ISO 62	%	<0.1	0.02	<0.1	2.5	<0.1	<0.1
Formaldehyde	–	ppm	absent	absent	absent	absent	absent	absent
Cadmium	–	ppm	absent	absent	absent	absent	absent	absent
Mechanical Properties								
Tensile Stress at Break	ASTM D638	MPa	39	28	30	45	17	15
Traction Strength	ASTM D638	MPa	44	27	27	55	9.5	9
Elongation at Break	ASTM D638	%	130	200	97	250	400	600
Modulus of Elasticity at Traction	ASTM D638	MPa	4400	n/a	–	950	–	240
Modulus of Elasticity at Flexion	ASTM D790	MPa	3200	2100	–	1100	210	130
Thermal Properties								
Temperature VICAT	ASTM D1525	°C	84	95	70	198	89	–
HDT	ASTM D648	°C	72	60	60	185	–	–
Coefficient of Expansion	ASTM D696	K ⁻¹	6 10 ⁻⁵	10 ⁻⁵	8 10 ⁻⁵	8-10 10 ⁻⁵	22 10 ⁻⁵	10 ⁻⁵
Specific Heat	ASTM C351	kJ/kgK	0.94	n/a	1.24	1.7	–	–
Thermal Conductivity	ASTM C177	W/mK	0.14	0.21	0.14	0.29	0.32	0.32
Electrical Properties								
Dielectric Constant	ASTM D150	–	3.2 - 4.0	2.5	3.2	5.0	2.4	2.3
Dielectric Strength	IEC 243	kV/mm	70	25	60	35	90	90
Surface Resistance	IEC 93	Ω	10 ¹³	10 ¹³	10 ¹³	5 10 ¹¹	10 ¹³	10 ¹³
Self-Extinguishing								
Self-Extinguishing UL 94 1.6 mm	UL 94	–	V-0	V-0	V-0	V-2	HB	V-2
Self-Extinguishing UL 94 3.2 mm	UL 94	–	V-0	V-0	V-0	V-2	HB	V-2
Hot Wire Test (2 mm)	IEC 695-2-1	°C	960	960	960	650	650	850
Oxygen Number	ASTM D2863	%	43	30	34	25	–	25