

# proSense® Thermowells



## Overview

- Thermowells designed for use with ProSense thermocouple and RTD probes or ProSense Thermometers eliminate the need for a separate probe mounting fitting or adapter

### RTDTW Series Thermowells

- Welded 316 stainless steel construction
- 1/2" NPT male process threads
- 3-year warranty

### TW Series Thermowells

- Drilled bar stock one piece construction (no welds) from 304 or 316 stainless steel
- 1/2" and 3/4" NPT male process threads available
- Designs and fabrication comply with ASME B31.1 and boiler and pressure vessel codes
- Material complies with NACE MR 0175 / ISO 15156
- CRN registered for all Canadian provinces
- 1-year warranty



## Thermowells for Thermocouples -TW Series

Part Number	Pcs/Pkg	Wt(lb)	Price	I.D.	Overall Length/"U" Length	Male Process Threads	Female Probe Threads	Wetted Material	Temperature/Pressure Rating	Use With Probe or Thermometer
<a href="#">TW025-01</a>	1	0.4		0.26"	2-3/4" / 1"	1/2" NPT	1/2" NPT	304 SS	304SS: 1000°F max; 3400psi max 316SS: 1000°F max; 5200psi max	See Sensor Compatibility Table
<a href="#">TW025-03</a>	1	0.4				1/2" NPT		316 SS		
<a href="#">TW04-01</a>	1	0.5			4-1/4" / 2-1/2"	1/2" NPT		304 SS		
<a href="#">TW04-02</a>	1	0.5				3/4" NPT		304 SS		
<a href="#">TW04-03</a>	1	0.5				1/2" NPT		316 SS		
<a href="#">TW04-04</a>	1	0.5				3/4" NPT		316 SS		
<a href="#">TW06-01</a>	1	0.7			6-1/4" / 4-1/2"	1/2" NPT		304 SS		
<a href="#">TW06-02</a>	1	0.7				3/4" NPT		304 SS		
<a href="#">TW06-03</a>	1	0.7				1/2" NPT		316 SS		
<a href="#">TW06-04</a>	1	0.7				3/4" NPT		316 SS		
<a href="#">TW09-01</a>	1	1.0			9-1/4" / 7-1/2"	1/2" NPT		304 SS		
<a href="#">TW09-03</a>	1	1.0				1/2" NPT		316 SS		
<a href="#">TW12-01</a>	1	1.2			12-1/4" / 10-1/2"	1/2" NPT		304 SS		
<a href="#">TW12-02</a>	1	1.2				3/4" NPT		304 SS		
<a href="#">TW12-03</a>	1	1.2				1/2" NPT		316 SS		
<a href="#">TW12-04</a>	1	1.2				3/4" NPT		316 SS		

# proSense® Thermowells

Thermowells for Thermocouples -RTDTW Series										
Part Number	Pcs/Pkg	Wt(lb)	Price	I.D.	Overall Length	Male Process Threads	Female Probe Threads	Wetted Material	Temperature/Pressure Rating	Use With
<a href="#"><u>RTDTW-06-010-50N</u></a>	1	0.10		7 mm (0.28")	113mm (4.4")	1/2" NPT	1/4" NPT	316 SS	600°F (315°C) max; 232 psi (16 bar) max	XTP-160-N40140F XTP-160-0300F XTP-160-0100C RTD0100-06-010-H CF06-25N fitting
<a href="#"><u>RTDTW-06-020-50N</u></a>	1	0.20	213mm (8.4")		XTP-260-N40140F XTP-260-0300F XTP-260-0100C RTD0100-06-020-H CF06-25N fitting					
<a href="#"><u>RTDTW-06-030-50N</u></a>	1	0.30	313mm (12.3")		XTP-360-N40140F XTP-360-0300F XTP-360-0100C RTD0100-06-030-H CF06-25N fitting					
<a href="#"><u>RTDTW-10-010-50N</u></a>	1	0.10	11 mm (0.43")	92mm (3.62")	1/2" NPT					RTD0100-10-010-H CF10-50N fitting
<a href="#"><u>RTDTW-10-030-50N</u></a>	1	0.22		292mm (11.48")						CF10-50N fitting



Note: Check the chemical compatibility of the thermowell's wetted parts with the medium to be measured.



Note: Response time will be slower when installed in a thermowell. Be sure to install the probe so that it contacts the end of the thermowell for faster response. Thermal compound may be used depending on application

## Probe & Thermowell Assembly Example

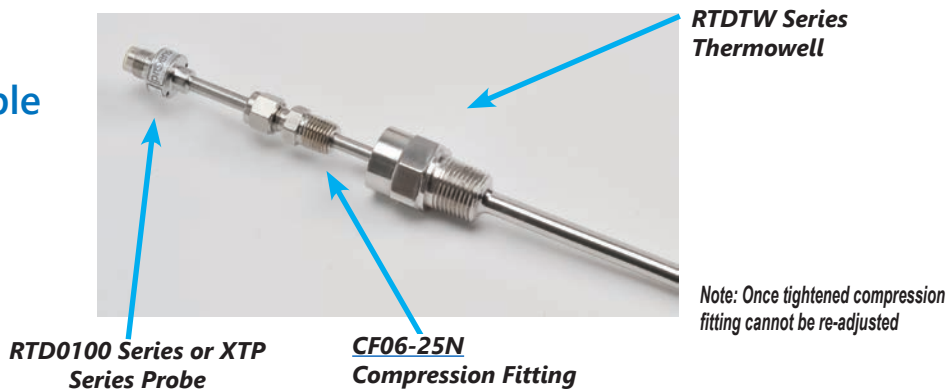

## Spring-loaded Thermocouple or RTD and Thermowell Assembly Example



- Using spring-loaded probe design ensures positive tip contact with the bottom of the thermowell.
- Probes with hex nipple thread directly into thermowell. No additional probe mounting fittings are required.

# proSense® Thermowells

## Dimensions

inches [mm]

TW04-XX & TW025-XX

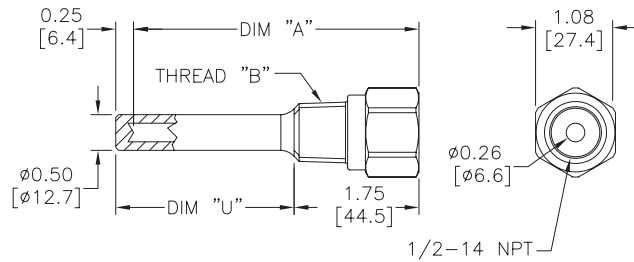

PART NUMBER	DIM "A"	THREAD "B" NPT	DIM "U"
TW025-01	2.50[63.5]	1/2-14	1.00[25.5]
TW025-03	2.50[63.5]	1/2-14	
TW04-01	4.00[101.6]	1/2-14	
TW04-02	4.00[101.6]	3/4-14	2.50[63.5]
TW04-03	4.00[101.6]	1/2-14	
TW04-04	4.00[101.6]	3/4-14	

## Dimensions

inches [mm]

TW06-XX  
TW09-XX  
TW12-XX

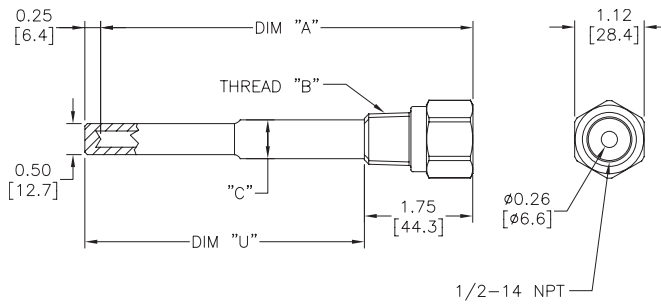

PART NUMBER	DIM "A"	THREAD "B" NPT	DIM "C"	DIM "U"
TW06-01	6.00[152.4]	1/2-14	0.63[15.9]	4.50[114.3]
TW06-02	6.00[152.4]	3/4-14	0.75[19.1]	
TW06-03	6.00[152.4]	1/2-14	0.63[15.9]	
TW06-04	6.00[152.4]	3/4-14	0.75[19.1]	7.50[190.5]
TW09-01	9.00[228.6]	1/2-14	0.63[15.9]	
TW09-03	9.00[228.6]	1/2-14	0.63[15.9]	
TW12-01	12.00[304.8]	1/2-14	0.63[15.9]	10.50[266.7]
TW12-02	12.00[304.8]	3/4-14	0.75[19.1]	
TW12-03	12.00[304.8]	1/2-14	0.63[15.9]	
TW12-04	12.00[304.8]	3/4-14	0.75[19.1]	

# proSense® Thermowells

## Dimensions

mm [inches]

### RTDTW-06 Series

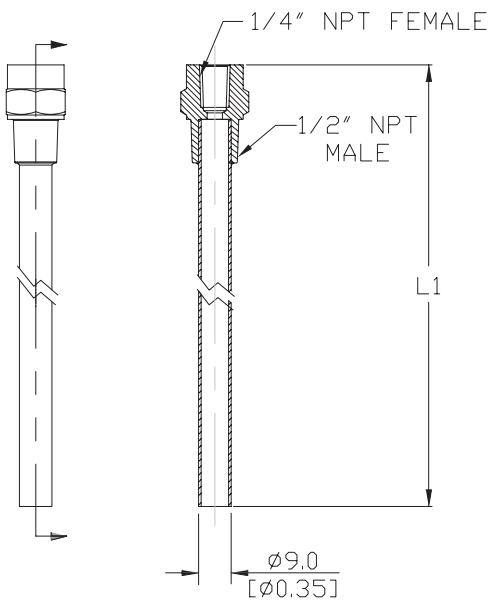

Part Number	L1
<a href="#">RTDTW-06-010-50N</a>	113mm [ 4.4]
<a href="#">RTDTW-06-020-50N</a>	213mm [ 8.4]
<a href="#">RTDTW-06-030-50N</a>	313mm [12.3]

Torque threads to 40 lb-ft [54.23 Nm]\*

\* Torque values are for reference. Actual torque required for a proper seal of NPT threads is influenced by tolerance, sealant, lubricant, etc.

### RTDTW-10 Series

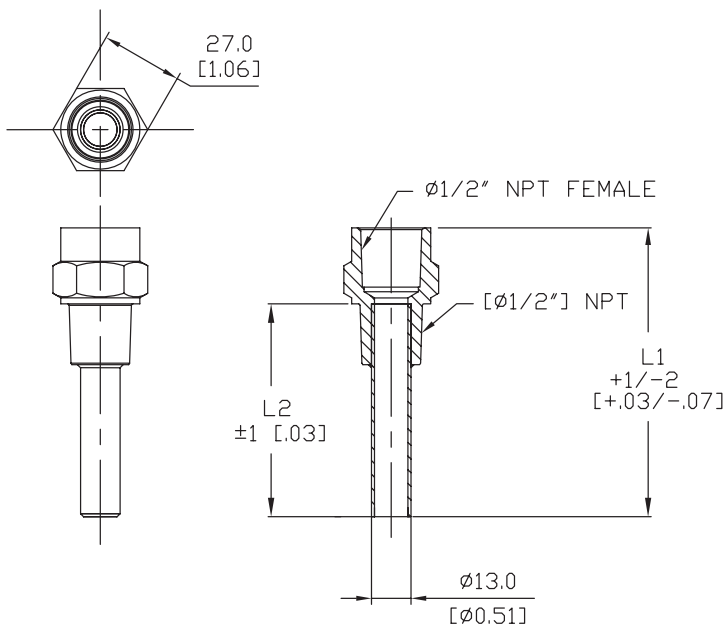









Part Number	L1	L2
<a href="#">RTDTW-10-030-50N</a>	92mm [ 3.62]	70mm [ 2.75]
<a href="#">RTDTW-10-050-50N</a>	292mm [11.48]	270mm [10.6]

Torque threads to 40 lb-ft [54.23 Nm]\*

# pro<sup>sense</sup> Thermowells

**TW Series Thermowells Sensor Compatibility Table**

	Junction Box	Connection Head	Hex Nipple	Attached Plug	Lead Wire Transition	M12	Thermometer
<b>Thermowell</b>							
<b><u>TW025-01</u></b> <b><u>TW025-03</u></b>	-	-	-	-	-	-	T30-N40160-25C T30-0250-25C T30-50500-25C T30-150750-25C T50-N40160-25A T50-0250-25A T50-50500-25A T50-150750-25A
<b><u>TW04-01</u></b> <b><u>TW04-02</u></b> <b><u>TW04-03</u></b> <b><u>TW04-04</u></b>	NTC10K3-JB04-03	RTD1-C04-03 THMJ-C04-03 THMK-C04-03 NTC10K3-C04-03	RTD1-H04L01-02 THMJ-H04L01-02 THMK-H04L01-02 NTC10K3-H04L01-02	RTD1-P06-01 w/ CF14-50N THMJ-P06-02 w/ CF14-50N THMK-P06-02 w/ CF14-50N NTC10K3-P06-02 w/ CF14-50N	RTD1-T06L06-01 w/ CF14-50N THMJ-T06L06-02 w/ CF14-50N THMK-T06L06-02 w/ CF14-50N NTC10K3-T06L06-02 w/CF14-50N	RTD1-50N-100-H RTD0100-06-010-H w/CF14-50N XTP-160-N40140F w/CF14-50N XTP-160-0300F w/CF14-50N XTP-160-0100C w/CF14-50N XTP50N-100-N40140F XTP50N-100-0300F XTP50N-100-0100C ETS50N-100-1001 ETS50N-100-1003	T30-N40160-4C T30-0250-4C T30-50500-4C T30-150750-4C T50-N40160-4A T50-0250-4A T50-50500-4A T50-150750-4A
<b><u>TW06-01</u></b> <b><u>TW06-02</u></b> <b><u>TW06-03</u></b> <b><u>TW06-04</u></b>	NTC10K3-JB06-03	RTD1-C06-03 THMJ-C06-03 THMK-C06-03 NTC10K3-C06-03	RTD1-H06L01-02 THMJ-H06L01-02 THMK-H06L01-02 NTC10K3-H06L01-02	RTD1-P12-01 w/ CF14-50N THMJ-P12-02 w/ CF14-50N THMK-P12-02 w/ CF14-50N NTC10K3-P12-02 w/ CF14-50N	RTD1-T12L06-01 w/ CF14-50N THMJ-T12L06-02 w/ CF14-50N THMK-T12L06-02 w/ CF14-50N NTC10K3-T12L06-02 w/CF14-50N	RTD1-50N-150-H RTD0100-06-020-H w/CF14-50N XTP-260-N40140F w/CF14-50N XTP-260-0300F w/CF14-50N XTP-260-0100C w/CF14-50N XTP50N-150-N40140F XTP50N-150-0300F XTP50N-150-0100C ETS50N-150-1001 ETS50N-150-1003	T30-N40160-6C T30-0250-6C T30-50500-6C T30-150750-6C T50-N40160-6A T50-0250-6A T50-50500-6A T50-150750-6A
<b><u>TW09-01</u></b> <b><u>TW09-03</u></b>	-	-	-	-	-	-	T50-N40160-9A T50-0250-9A T50-50500-9A T50-150750-9A
<b><u>TW12-01</u></b> <b><u>TW12-02</u></b> <b><u>TW12-03</u></b> <b><u>TW12-04</u></b>	NTC10K3-JB12-03	RTD1-C12-03 THMJ-C12-03 THMK-C12-03 NTC10K3-C12-03	RTD1-H12L01-02 THMJ-H12L01-02 THMK-H12L01-02 NTC10K3-H12L01-02	RTD1-P18-01 w/ CF14-50N THMJ-P18-02 w/ CF14-50N THMK-P18-02 w/ CF14-50N NTC10K3-P18-02 w/ CF14-50N	RTD1-T18L06-01 w/ CF14-50N THMJ-T18L06-02 w/ CF14-50N THMK-T18L06-02 w/ CF14-50N NTC10K3-T18L06-02 w/CF14-50N	RTD0100-06-030-H w/CF14-50N XTP-360-N40140F w/CF14-50N XTP-360-0300F w/CF14-50N XTP-360-0100C w/CF14-50N	-

 *Note: Response time will be slower when installed in a thermowell. Be sure to install the probe so that it contacts the end of the thermowell for faster response. Thermal compound may be used depending on application.*

# proSense® Thermowells Sanitary Clean-in-Place (CIP)



STW06-01

## Overview

- Sanitary Clean-In-Place 3-A approved thermowells allow the use of standard temperature sensors in hygienic applications
- All wetted parts are 316 stainless steel
- Surface finish that meets or exceeds 32µin Ra
- Up to 1500/1200 psi (103/83 bar) at 70/250 °F (21/121 °C) dependent on clamp and seal assembly.
- Bore diameter of 0.260" to accommodate sensing probes with a 0.252" maximum diameter
- Probes with integral 1/2" male NPT process threads mount directly into the thermowell. Probes without threads require a compression fitting with 1/2" male NPT threads.



Thermowells Sanitary Clean-in-Place (CIP)									
Part Number	Pcs/Pkg	Wt(lb)	Price	I.D.	Overall Length/"U" Length	Process Connection	Female Probe Threads	Wetted Material	Use With
<a href="#">STW04-01</a>	1	0.75		ø0.260	4-1/4" / 2-1/2"	1-1/2" tri-clamp	1/2" NPT	316 stainless steel	See Sensor Compatibility Table
<a href="#">STW06-01</a>	1	0.88			6-1/4" / 4-1/2"				
<a href="#">STW12-01</a>	1	1.13			12-1/4" / 10-1/2"				
<a href="#">STW04-02</a>	1	0.75			4-1/4" / 2-1/2"	2" tri-clamp			
<a href="#">STW06-02</a>	1	0.88			6-1/4" / 4-1/2"				
<a href="#">STW12-02</a>	1	1.13			12-1/4" / 10-1/2"				

- Note: Check the chemical compatibility of the thermowell's wetted parts with the medium to be measured.
- Note: Response time will be slower when installed in a thermowell. Be sure to install the probe so that it contacts the end of the thermowell for faster response. Thermal compound may be used depending on application

## Probe & Thermowell Assembly Example

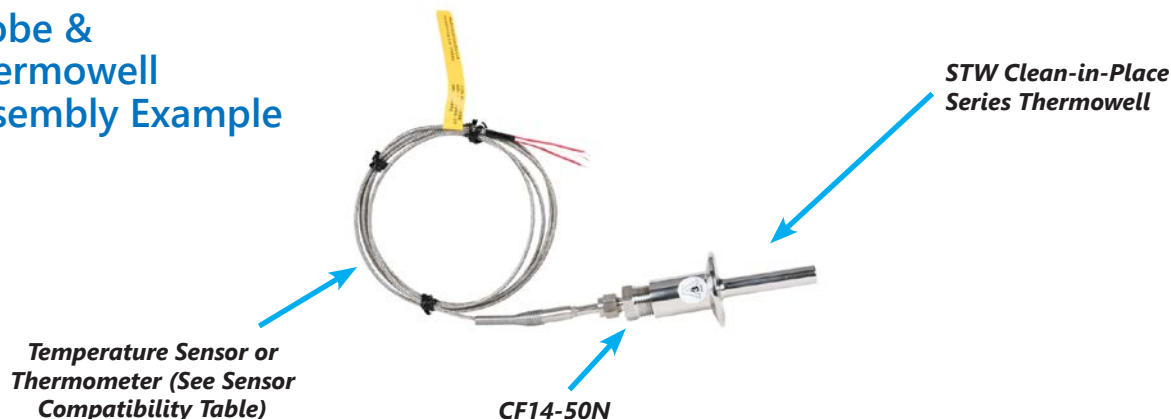

# proSense® Thermowells Sanitary Clean-in-Place (CIP)

## Spring-loaded Thermocouple or RTD and Thermowell Assembly Example



- Using spring-loaded probe design ensures positive tip contact with the bottom of the thermowell.
- Probes with hex nipple thread directly into thermowell. No additional probe mounting fittings are required.

### Dimensions

inches [mm]

STWXX-XX

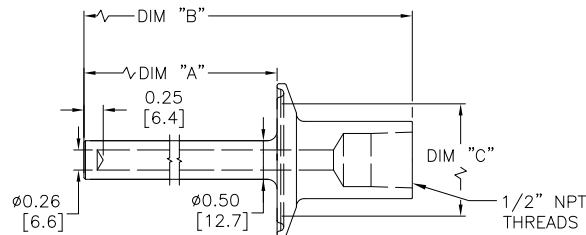









TABLE A

PART NUMBER	DIM "A"	DIM "B"	DIM "C"
STW04-01	2.50[63.5]	4.25[108.0]	1.50[38.1]
STW06-01	4.50[114.3]	6.25[158.8]	1.50[38.1]
STW12-01	10.50[266.8]	12.25[311.3]	1.50[38.1]
STW04-02	2.50[63.5]	4.25[108.0]	2.00[50.8]
STW06-02	4.50[114.3]	6.25[158.5]	2.00[50.8]
STW12-02	10.50[266.8]	12.25[311.3]	2.00[50.8]



# Thermowells Sanitary Clean-in-Place (CIP)

**Thermowells Sanitary Clean-in-Place (CIP) Sensors Compatibility Table**

	Junction Box	Connection Head Sensor	Hex Nipple Sensor	Attached Plug Sensor	Lead Wire Transition Sensor	M12 Sensor	Thermometer
<b>Thermowell</b>							
<b>STW04-01</b>	NTC10K3-JB04-03	RTD1-C04-03 THMJ-C04-03 THMK-C04-03 NTC10K3-C04-03	RTD1-H04L01-02 THMJ-H04L01-02 THMK-H04L01-02 NTC10K3-H04L01-02	RTD1-P06-01 w/ CF14-50N THMJ-P06-02 w/ CF14-50N THMK-P06-02 w/ CF14-50N NTC10K3-P06-02 w/ CF14-50N	RTD1-T06L06-01 w/ CF14-50N THMJ-T06L06-02 w/ CF14-50N THMK-T06L06-02 w/ CF14-50N	RTD1-50N-100-H RTD0100-06-010-H w/CF14-50N XTP-160-N40140F w/CF14-50N XTP-160-0300F w/CF14-50N XTP-160-0100C w/CF14-50N XTP50N-100-N40140F XTP50N-100-0300F XTP50N-100-0100C ETS50N-100-1001 ETS50N-100-1003	T30-N40160-4C T30-0250-4C T30-50500-4C T30-150750-4C T50-N40160-4A T50-0250-4A T50-50500-4A T50-150750-4A
<b>STW06-01</b>	NTC10K3-JB06-03	RTD1-C06-03 THMJ-C06-03 THMK-C06-03 NTC10K3-C06-03	RTD1-H06L01-02 THMJ-H06L01-02 THMK-H06L01-02 NTC10K3-H06L01-02	RTD1-P12-01 w/ CF14-50N THMJ-P12-02 w/ CF14-50N THMK-P12-02 w/ CF14-50N NTC10K3-P12-02 w/ CF14-50N	RTD1-T12L06-01 w/ CF14-50N THMJ-T12L06-02 w/ CF14-50N THMK-T12L06-02 w/ CF14-50N	RTD1-50N-150-H RTD0100-06-020-H w/CF14-50N XTP-260-N40140F w/CF14-50N XTP-260-0300F w/CF14-50N XTP-260-0100C w/CF14-50N XTP50N-150-N40140F XTP50N-150-0300F XTP50N-150-0100C ETS50N-150-1001 ETS50N-150-1003	T30-N40160-6C T30-0250-6C T30-50500-6C T30-150750-6C T50-N40160-6A T50-0250-6A T50-50500-6A T50-150750-6A
<b>STW12-01</b>	NTC10K3-JB12-03	RTD1-C12-03 THMJ-C12-03 THMK-C12-03 NTC10K3-C12-03	RTD1-H12L01-02 THMJ-H12L01-02 THMK-H12L01-02 NTC10K3-H12L01-02	RTD1-P18-01 w/ CF14-50N THMJ-P18-02 w/ CF14-50N THMK-P18-02 w/ CF14-50N NTC10K3-P18-02 w/ CF14-50N	RTD1-T18L06-01 w/ CF14-50N THMJ-T18L06-02 w/ CF14-50N THMK-T18L06-02 w/ CF14-50N	RTD0100-06-030-H w/CF14-50N XTP-360-N40140F w/CF14-50N XTP-360-0300F w/CF14-50N XTP-360-0100C w/CF14-50N	-
<b>STW04-02</b>	NTC10K3-JB04-03	RTD1-C04-03 THMJ-C04-03 THMK-C04-03 NTC10K3-C04-03	RTD1-H04L01-02 THMJ-H04L01-02 THMK-H04L01-02 NTC10K3-H04L01-02	RTD1-P06-01 w/ CF14-50N THMJ-P06-02 w/ CF14-50N THMK-P06-02 w/ CF14-50N NTC10K3-P06-02 w/ CF14-50N	RTD1-T06L06-01 w/ CF14-50N THMJ-T06L06-02 w/ CF14-50N THMK-T06L06-02 w/ CF14-50N	RTD1-50N-100-H RTD0100-06-010-H w/CF14-50N XTP-160-N40140F w/CF14-50N XTP-160-0300F w/CF14-50N XTP-160-0100C w/CF14-50N XTP50N-100-N40140F XTP50N-100-0300F XTP50N-100-0100C ETS50N-100-1001 ETS50N-100-1003	T30-N40160-4C T30-0250-4C T30-50500-4C T30-150750-4C T50-N40160-4A T50-0250-4A T50-50500-4A T50-150750-4A
<b>STW06-02</b>	NTC10K3-JB06-03	RTD1-C06-03 THMJ-C06-03 THMK-C06-03 NTC10K3-C06-03	RTD1-H06L01-02 THMJ-H06L01-02 THMK-H06L01-02 NTC10K3-H06L01-02	RTD1-P12-01 w/ CF14-50N THMJ-P12-02 w/ CF14-50N THMK-P12-02 w/ CF14-50N NTC10K3-P12-02 w/ CF14-50N	RTD1-T12L06-01 w/ CF14-50N THMJ-T12L06-02 w/ CF14-50N THMK-T12L06-02 w/ CF14-50N	RTD1-50N-150-H RTD0100-06-020-H w/CF14-50N XTP-260-N40140F w/CF14-50N XTP-260-0300F w/CF14-50N XTP-260-0100C w/CF14-50N XTP50N-150-N40140F XTP50N-150-0300F XTP50N-150-0100C ETS50N-150-1001 ETS50N-150-1003	T30-N40160-6C T30-0250-6C T30-50500-6C T30-150750-6C T50-N40160-6A T50-0250-6A T50-50500-6A T50-150750-6A
<b>STW12-02</b>	NTC10K3-JB12-03	RTD1-C12-03 THMJ-C12-03 THMK-C12-03 NTC10K3-C12-03	RTD1-H12L01-02 THMJ-H12L01-02 THMK-H12L01-02 NTC10K3-H12L01-02	RTD1-P18-01 w/ CF14-50N THMJ-P18-02 w/ CF14-50N THMK-P18-02 w/ CF14-50N NTC10K3-P18-02 w/ CF14-50N	RTD1-T18L06-01 w/ CF14-50N THMJ-T18L06-02 w/ CF14-50N THMK-T18L06-02 w/ CF14-50N	RTD0100-06-030-H w/CF14-50N XTP-360-N40140F w/CF14-50N XTP-360-0300F w/CF14-50N XTP-360-0100C w/CF14-50N	-

 Note: Response time will be slower when installed in a thermowell. Be sure to install the probe so that it contacts the end of the thermowell for faster response. Thermal compound may be used depending on application.