

DM Series Photoelectric Sensors

M12 (12mm) Metal with Teach Function - DC



- Metal housing
- Teach function available on diffuse and polarized reflective models
- Adjustable sensitivity on through-beam models
- Axial cable or M12 quick-disconnect models; purchase cable separately
- Multifunction LED status indicator
- Operates on 10–30 VDC
- IP67 rated



DM Series Photoelectric Sensors Selection Chart								
Part Number	Price	Sensing Range	Output State	Logic	Connection	Wiring	Dimensions	Characteristic Curves
Diffuse								
DM3-0N-1A		Up to 100mm [3.9in]	N.O. + N.C. Selectable	NPN	2m [6.5ft] axial cable	Diagram 1	Figure 1	Chart 1
DM3-0P-1A				PNP	2m [6.5ft] axial cable	Diagram 2	Figure 1	Chart 1
DM3-0N-1H				NPN	M12 connector	Diagram 1	Figure 2	Chart 1
DM3-0P-1H				PNP	M12 connector	Diagram 2	Figure 2	Chart 1
DM7-0N-1A		Up to 300mm [11.8in]	N.O. + N.C. Selectable	NPN	2m [6.5ft] axial cable	Diagram 1	Figure 1	Chart 2
DM7-0P-1A				PNP	2m [6.5ft] axial cable	Diagram 2	Figure 1	Chart 2
DM7-0N-1H				NPN	M12 connector	Diagram 1	Figure 2	Chart 2
DM7-0P-1H				PNP	M12 connector	Diagram 2	Figure 2	Chart 2
Polarized Reflective*								
DMP-0N-1A		Up to 2m [6.6ft]	N.O. + N.C. Selectable	NPN	2m [6.5ft] axial cable	Diagram 1	Figure 1	Chart 3
DMP-0P-1A				PNP	2m [6.5ft] axial cable	Diagram 2	Figure 1	Chart 3
DMP-0N-1H				NPN	M12 connector	Diagram 1	Figure 2	Chart 3
DMP-0P-1H				PNP	M12 connector	Diagram 2	Figure 2	Chart 3
Through-beam**								
DMR-0N-1A	Receiver	Up to 4m [13.1ft]	N.O. + N.C. Selectable	NPN	2m [6.5ft] axial cable	Diagram 1	Figure 1	Chart 4
DMR-0P-1A	Receiver			PNP	2m [6.5ft] axial cable	Diagram 2	Figure 1	Chart 4
DMR-0N-1H	Receiver			NPN	M12 connector	Diagram 1	Figure 2	Chart 4
DMR-0P-1H	Receiver			PNP	M12 connector	Diagram 2	Figure 2	Chart 4
DME-00-1A	Emitter			Receiver dependent	2m [6.5ft] axial cable	Diagram 3	Figure 1	Chart 4
DME-00-1H	Emitter			M12 connector	Diagram 3	Figure 2	Chart 4	

* Purchase reflectors separately. **Purchase one receiver and one emitter for a complete set.

Wiring Diagrams

Diagram 1
NPN Output

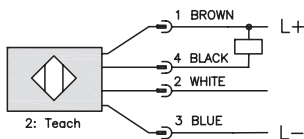

Diagram 2
PNP Output

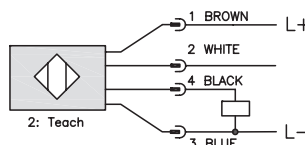
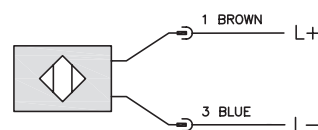
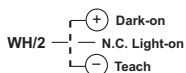

Diagram 3
Emitter with check Input



2-meter Axial Cable version: check is black
M12 Connector: check is Pin 2 (white)

Diffuse models



Polarized reflective models

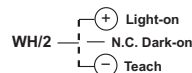

Through-beam models



Connector

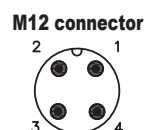

DM Series Photoelectric Sensors

DM Series Photoelectric Sensors Specifications			
Specifications	Diffuse Models	Reflective Models	Through-Beam Models
Type	Diffuse reflection	Polarized reflection ⁴	Through-beam ⁵
Sensing Distance	DM3: 100mm ¹ DM7: 300mm ²	2m ³	4m
Light Spot Diameter	DM3: 80mm @ 100mm DM7: 200mm @ 300mm	100mm @ 2.5m	350mm @ 4m
Emission	Infrared [880nm]	Red [660nm]	Infrared [880nm]
Sensitivity	Teach function (see product data sheet for details)		Fixed
Output Type	NPN or PNP - Light on / Dark on selectable		
Operating Voltage	10-30VDC		
No-load Supply Current	≤20 mA		
Operating (Load) Current	≤100 mA		
Off-state Leakage Current	≤10 μA		
Voltage Drop	2V max at 100 mA		
Switching Frequency	400 Hz		250 Hz
Ripple	≤10%		
Time Delay Before Availability (tv)	150 ms		
Short-Circuit Protection	Yes, switch auto-resets after load is removed		
Operating Temperature	-25 to +70 °C [-13 to +158 °F]		
Protection Degree (DIN 40050)	IEC IP67		
LED Indicators - Switching Status	Yellow		
Housing Material	Nickel-plated brass		
Lens Material	Polymethyl methacrylate (PMMA)		
Shock/Vibration	See terminology section		
Tightening Torque	10 N•m (7.37 lb-ft)		
Weight	Axial cable models: 54g [1.9 oz] M12 connector models: 18g [0.63 oz]		
Connectors	2m [6.5ft] axial cable; M12 [12mm] connector		
Agency Approvals	cULus F187310, CE		

¹ With 100x100mm white matte paper

² With 200x200mm white matte paper

³ With standard Ø84mm RL110 reflector

⁴ Purchase reflectors separately.

⁵ An emitter (DME) and receiver (DMR) pair must be ordered for a complete sensor set.

To obtain the most current agency approval information, see the Agency Approval Checklist section on the specific part number's web page.

Dimensions

(mm)

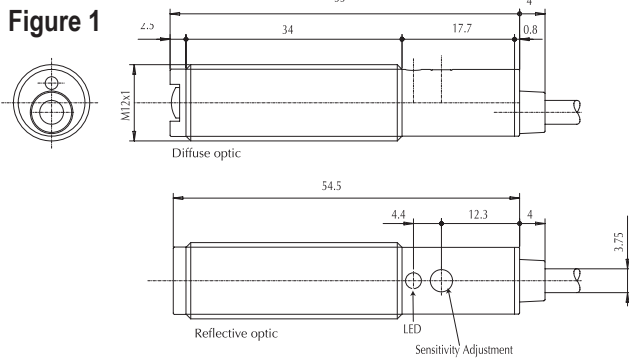

(Diffuse and Reflective only)

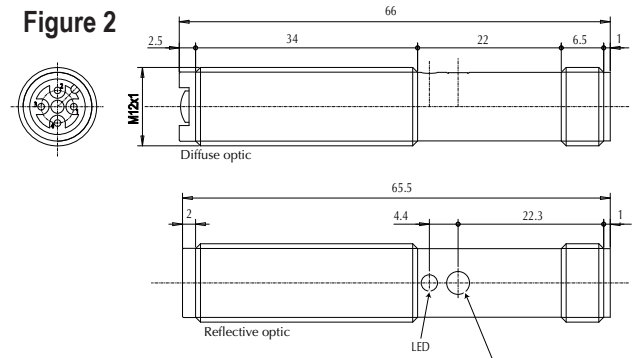

(Diffuse and Reflective only)

Switching Element Function		
	Through-beam and Reflective Models	Diffuse Reflective Models
Light-on	N.C.	N.O.
Dark-on	N.O.	N.C.

DM Series Photoelectric Sensors

Characteristic curves

Chart 1 (Diffuse DM3)

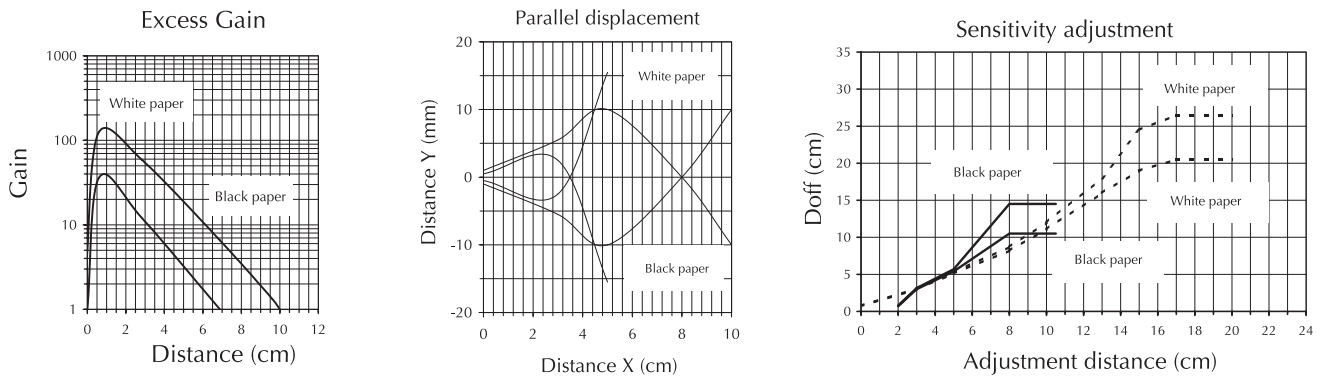

Chart 2 (Diffuse DM7)

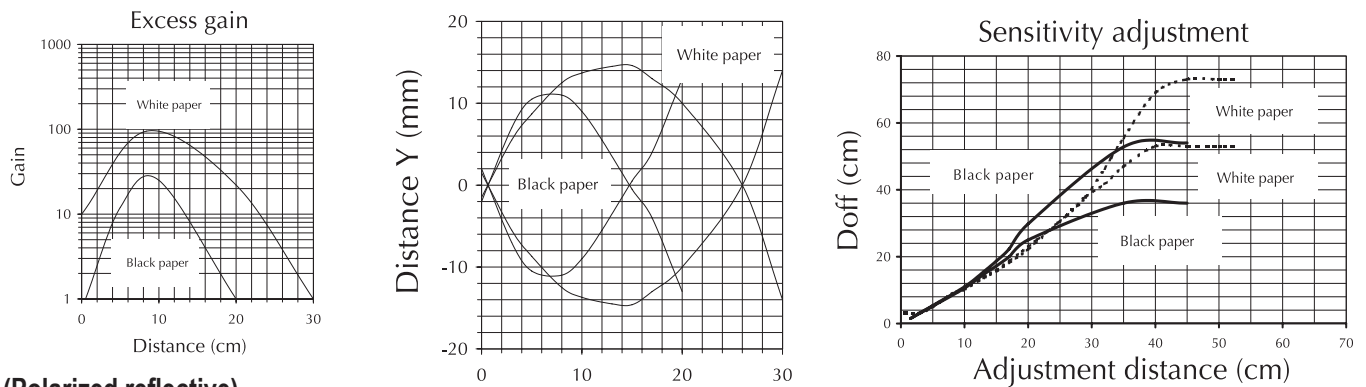

Chart 3 (Polarized reflective)

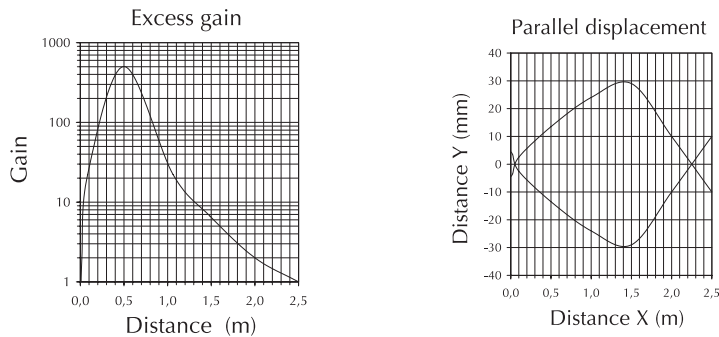
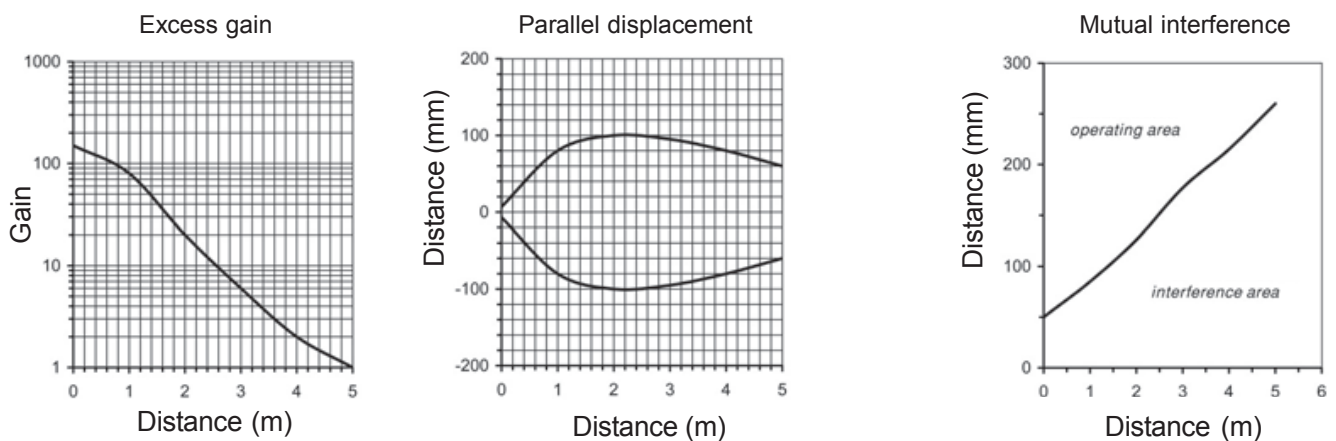

Chart 4 (Through-beam)



WARNING: THESE PRODUCTS ARE NOT SAFETY SENSORS AND ARE NOT SUITABLE FOR USE IN PERSONAL SAFETY APPLICATIONS.

Accessories for 12mm Sensors

Axial Mounting Bracket

Mounting bracket, axial, available in zinc-plated steel or 316L stainless steel. For use with 12mm sensors. Has two mounting holes (use 3mm screws) and allows the rotation of an optical axis for right-angle adapter sensors. Hexagonal nuts not included.

Accessories for 12mm Sensors				
Part Number	Price	Description	Drawing Link	Weight lb [g]
ST12A		Micro Detectors mounting bracket, axial, zinc plated steel. For use with 12mm sensors.	PDF	0.03 [13.6]
ST12A7W		Micro Detectors mounting bracket, axial, 316L stainless steel. For use with 12mm sensors.	PDF	0.03 [13.6]



[ST12A](#)

Right-angle Mounting Bracket

Mounting bracket, right-angle, zinc-plated steel or 316L stainless steel. For use with 12mm sensors. Has two mounting holes (use 3mm screws) and allows the rotation of an optical axis for axial sensors. Hexagonal screws not included.

Accessories for 12mm Sensors				
Part Number	Price	Description	Drawing Link	Weight lb [g]
ST12C		Micro Detectors mounting bracket, right-angle, zinc plated steel. For use with 12mm sensors.	PDF	0.03 [13.6]
ST12C7W		Micro Detectors mounting bracket, right-angle, 316L stainless steel. For use with 12mm sensors.	PDF	0.03 [13.6]



[ST12C](#)

Accessories for 12mm Sensors

Right-angle Fine Tune Mounting Bracket

Mounting bracket, right-angle, fine tune vertical and horizontal adjustment, nickel-plated steel. For use with 12mm sensors. Enables fine tuning vertical and horizontal placement.

Accessories for 12mm Sensors				
Part Number	Price	Description	Drawing Link	Weight [lb]
OPT2035		Wenglor mounting bracket, right-angle, fine tune vertical and horizontal adjustment, nickel plated steel. For use with 12mm sensors.	PDF	0.16



[OPT2035](#)

Accessories for 12mm Sensors

Right-angle Mounting Brackets

Mounting bracket, right-angle, fixed insertion stop adjustment, plastic. For use with 12mm sensors. Available with or without fixed insertion stop.

Accessories for 12mm Sensors				
Part Number	Price	Description	Drawing Link	Weight lb [g]
OPT2102		Wenglor mounting bracket, right-angle, fixed insertion stop adjustment, plastic. For use with 12mm sensors.	PDF	0.05 [22.7]
OPT2103		Wenglor mounting bracket, right-angle, plastic. For use with 12mm sensors.	PDF	0.05 [22.7]



[OPT2102](#), [OPT2103](#)

Right-angle Swivel Mounting Systems

Mounting bracket, right-angle swivel, 360-degree vertical and horizontal adjustment, 12mm rod mount. For use with 12mm sensors. Available in all stainless steel or with an aluminum head and stainless steel mounting plate.

Accessories for 12mm Sensors						
Part Number	Price	Description	Mounting Head	Mounting Plate	Drawing Link	Weight lb [g]
OPT2114		Wenglor mounting bracket, right-angle swivel, 360 degree vertical and horizontal adjustment, aluminum, 12mm rod mount. For use with 12mm sensors.	Aluminum	Stainless steel	PDF	0.14 [63.5]
OPT2115		Wenglor mounting bracket, right-angle swivel, 360 degree vertical and horizontal adjustment, 304 stainless steel, 12mm rod mount. For use with 12mm sensors.	304 Stainless steel	304 Stainless steel	PDF	0.27 [122.5]



[OPT2114](#), [OPT2115](#)

Note: 304 stainless steel mounting rods sold separately: [OPT2109](#) (200mm [7.87in] length), [OPT2110](#) (300mm [11.81in] length), and [OPT2111](#) (500mm [19.69in] length).

Mounting Rods and Brackets

Mounting Rods

304 Stainless steel rods for mounting swivel brackets [OPT2112](#) - [OPT2127](#). Available in three lengths: 200mm, 300mm, and 500mm. 12mm diameter.

Mounting Rods for OPT2112 - 2127 Swivel Mounting Brackets				
Part Number	Price	Description	Drawing Link	Weight lb [g]
OPT2109		Wenglor mounting rod, 12mm diameter, 200mm length, 304 stainless steel.	PDF	0.41 [185.97]
OPT2110		Wenglor mounting rod, 12mm diameter, 300mm length, 304 stainless steel.	PDF	0.60 [272.16]
OPT2111		Wenglor mounting rod, 12mm diameter, 500mm length, 304 stainless steel.	PDF	0.98 [444.52]



Right-angle Mounting Bracket

Mounting bracket, right-angle, nickel-plated brass. For use with 12mm mounting rods [OPT2109](#), [OPT2110](#) & [OPT2111](#).

Right-angle Mounting Bracket for 12mm Sensors				
Part Number	Price	Description	Drawing Link	Weight lb [g]
OPT2108		Wenglor mounting bracket, right-angle, nickel-plated brass. For use with 12mm mounting rods OPT2109 , OPT2110 & OPT2111 .	PDF	0.07 [31.8]



Reflectors

RL Series Reflectors for Polarized Reflective Photoelectric Sensors (All Models)

- Suitable for use with polarized light photoelectric sensors
- Shapes and sizes for most applications
- Miniature types for close mounting in multiple sensor installations
- Single hole, dual hole and self-adhesive mounting types available
- Single and 10-packs available

Installation Notes

- Keep the reflector surface clean to ensure peak detection performance. This is especially true when the maximum sensing range is being used. Clean using a damp cloth.
- When selecting a reflector, it is important to consider the ambient conditions it will be exposed to. Dusty or high humidity conditions may reduce the sensing range as much as 90%.
- Reflectors should be positioned at a 90° angle to the optical axis with a tolerance of ±15°.

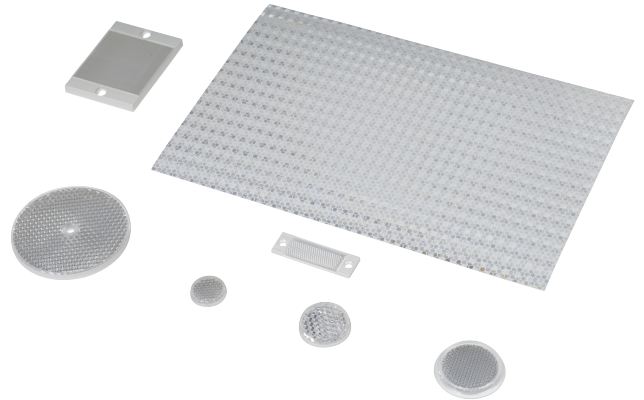

Reflector Specifications								
Part number	Price	Drawing Link	Quantity	Dimensions mm [in]	Degree of Protection	Mounting	Materials	
RL102		PDF	10	25 [0.98]	IEC IP67	Customer-supplied adhesive or other mounting method required	Reflective face: PMMA Polymethylmethacrylate (acrylic) Base material: ABS (Acrylonitrile-butadiene-styren)	
RL102-1			1					
RL103		PDF	10	34.5 [1.36]				
RL103-1			1					
RL104		PDF	10	46 [1.81]				Two 4.3mm holes
RL104-1			1					
RL105G		PDF	10	95 x 38 [3.74 x 1.50]		Two 6mm holes		
RL105G-1			1					
RL106G		PDF	10	182 x 42 [7.17 x 1.65]		One 5mm hole		
RL106G-1			1					
RL110		PDF	10	84 [3.31]		Two 3mm holes		
RL110-1			1					
RL116		PDF	10	41 x 60 [3.54 x 2.36]		Self-adhesive	Paper (Acrylic tape with micro prism)	
RL116-1			1					
RL100DA4		NA	1	200 x 300 [7.87 x 11.81]		Two 3mm slots	Reflective face: PMMA Polymethylmethacrylate (acrylic) Base material: ABS (Acrylonitrile-butadiene-styren)	
RL100DC4		NA	1	50 x 300 [1.97 x 11.81]				
RL100DQ1		NA	1	100 x 100 [3.94 x 3.94]	Two 4mm slots			
RL111G		PDF	10	22.5 x 47 [0.89 x 1.85]				
RL111G-1			1					
RL112G		PDF	10	19 x 73 [0.75 x 2.87]				
RL112G-1			1					
RL113G		PDF	10	51.4 x 60.3 [2.02 x 2.37]				
RL113G-1			1					

Not recommended for applications involving moist air environments or water immersion.

Reflectors

RL Series Reflectors for Polarized Reflective Laser Photoelectric Sensors (FALN series)

- Suitable for use with polarized light laser photoelectric sensors
- Sizes for most applications
- Miniature types for close mounting in multiple sensor installations
- Single and 5-packs available

Specifications						
Part Number	<i>RL201</i>	<i>RL201-1</i>	<i>RL203</i>	<i>RL203-1</i>	<i>RL204</i>	<i>RL204-1</i>
Price						
Quantity	5	1	5	1	5	1
Drawing Link	PDF		PDF		PDF	
Dimensions	60 x 82mm 2.36 x 3.23in		19 x 6mm 0.75 x 2.36in		20mm x 32mm 0.80 in x 1.26in	
Degree of Protection ¹	IEC IP67					
Mounting	Two 0.4mm holes		Two 0.4mm holes		Two 0.3mm holes	
Materials	Acrylic/polycarbonate					

¹ Not recommended for applications involving moist air environments or water immersion.