



Pneumatic A-Series Direction Control Solenoid Valves - Accessories



AVC1-12D



AVC2-12D

| Pneumatic A-Series Directional Control Solenoid Valve Series Accessories | | | |
|--|-------|---|-------------|
| Part No. | Price | Description | Weight (lb) |
| <u>AVC1-12D</u> | | NITRA solenoid coil, 12 VDC, 2.5 W. For use with AVS-31 and AVS-51 series valves. | 0.1 |
| <u>AVC1-24D</u> | | NITRA solenoid coil, 24 VDC, 2.5 W. For use with AVS-31 and AVS-51 series valves. | 0.1 |
| <u>AVC1-24A</u> | | NITRA solenoid coil, 24 VAC, 4.0 VA. For use with AVS-31 and AVS-51 series valves. | 0.1 |
| <u>AVC1-120A</u> | | NITRA solenoid coil, 120 VAC, 3.5 VA. For use with AVS-31 and AVS-51 series valves. | 0.1 |
| <u>AVC2-12D</u> | | NITRA solenoid coil, 12 VDC, 3W. For use with AVP-31, AVS-32, AVS-33, AVS-52, AVS-53, AVS-54 series valves and ASD series soft starters. | 0.2 |
| <u>AVC2-24D</u> | | NITRA solenoid coil, 24 VDC, 3W. For use with AVP-31, AVS-32, AVS-33, AVS-52, AVS-53, AVS-54 series valves and ASD series soft starters. | 0.2 |
| <u>AVC2-24A</u> | | NITRA solenoid coil, 24 VAC, 5 VA. For use with AVP-31, AVS-32, AVS-33, AVS-52, AVS-53, AVS-54 series valves and ASD series soft starters. | 0.2 |
| <u>AVC2-120A</u> | | NITRA solenoid coil, 120 VAC, 4.5 VA. For use with AVP-31, AVS-32, AVS-33, AVS-52, AVS-53, AVS-54 series valves and ASD series soft starters. | 0.2 |
| <u>AVP-31BKT</u> | | NITRA individual mounting bracket, plated steel. For use with AVP-31 directional control valves. | 0.1 |
| <u>AVP-31KIT</u> | | NITRA stacking screws, for use with AVP-31 directional control valves. One kit is required for each additional AVP-31 valve added to the stack. | 0.1 |

Dimensions

mm [inches]



AVP-31BKT



AVP-31KIT

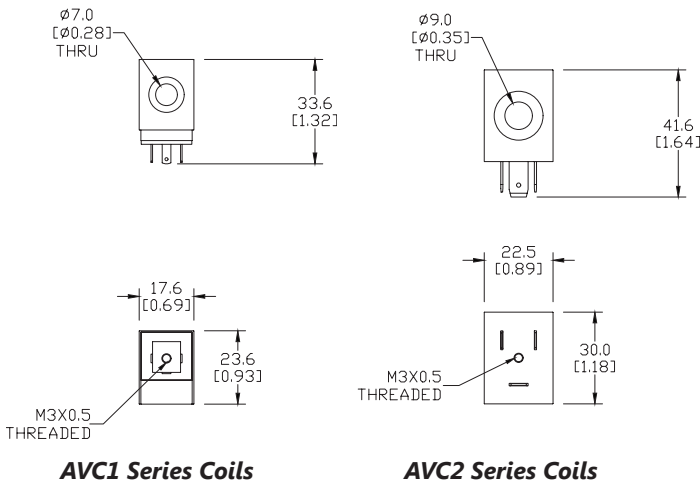

AVC1 Series Coils

AVC2 Series Coils

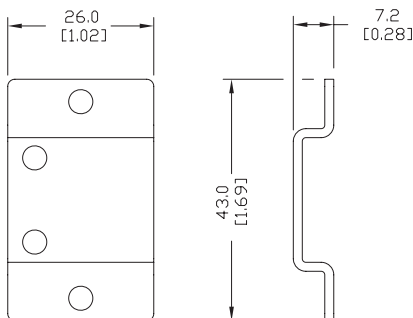

AVP-31BKT

See our website www.AutomationDirect.com for complete Engineering drawings.



Pneumatic Directional Control Solenoid Valve Manifolds and Accessories

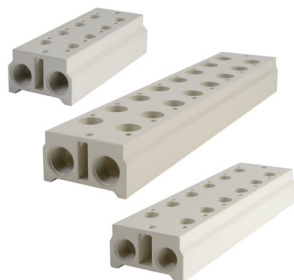

AM-3 Series Manifolds



AM-31BP

| Pneumatic Directional Control Solenoid Valve Series Accessories | | | |
|---|-------|---|-------------|
| Part No. | Price | Description | Weight (lb) |
| <u>AM-312</u> | | NITRA pneumatic valve manifold, aluminum, 2 stations, (2) 1/4 in FNPT inlet port(s), (2) 1/4 in FNPT exhaust port(s). For use with AVS-31 series. | 0.2 |
| <u>AM-314</u> | | NITRA pneumatic valve manifold, aluminum, 4 stations, (2) 1/4 in FNPT inlet port(s), (2) 1/4 in FNPT exhaust port(s). For use with AVS-31 series. | 0.3 |
| <u>AM-316</u> | | NITRA pneumatic valve manifold, aluminum, 6 stations, (2) 1/4 in FNPT inlet port(s), (2) 1/4 in FNPT exhaust port(s). For use with AVS-31 series. | 0.4 |
| <u>AM-318</u> | | NITRA pneumatic valve manifold, aluminum, 8 stations, (2) 1/4 in FNPT inlet port(s), (2) 1/4 in FNPT exhaust port(s). For use with AVS-31 series. | 0.5 |
| <u>AM-31BP</u> | | NITRA blanking plate, plated steel. For use with AM-31 series manifolds. | 0.1 |
| <u>AM-322</u> | | NITRA pneumatic valve manifold, aluminum, 2 stations, (2) 1/4 in FNPT inlet port(s), (2) 1/4 in FNPT exhaust port(s). For use with AVS-32 series. | 0.2 |
| <u>AM-324</u> | | NITRA pneumatic valve manifold, aluminum, 4 stations, (2) 1/4 in FNPT inlet port(s), (2) 1/4 in FNPT exhaust port(s). For use with AVS-32 series. | 0.4 |
| <u>AM-326</u> | | NITRA pneumatic valve manifold, aluminum, 6 stations, (2) 1/4 in FNPT inlet port(s), (2) 1/4 in FNPT exhaust port(s). For use with AVS-32 series. | 0.5 |
| <u>AM-328</u> | | NITRA pneumatic valve manifold, aluminum, 8 stations, (2) 1/4 in FNPT inlet port(s), (2) 1/4 in FNPT exhaust port(s). For use with AVS-32 series. | 0.7 |
| <u>AM-32BP</u> | | NITRA blanking plate, plated steel. For use with AM-32 series manifolds. | 0.1 |
| <u>AM-332</u> | | NITRA pneumatic valve manifold, aluminum, 2 stations, (2) 3/8 in FNPT inlet port(s), (2) 3/8 in FNPT exhaust port(s). For use with AVS-33 series. | 0.4 |
| <u>AM-334</u> | | NITRA pneumatic valve manifold, aluminum, 4 stations, (2) 3/8 in FNPT inlet port(s), (2) 3/8 in FNPT exhaust port(s). For use with AVS-33 series. | 0.6 |
| <u>AM-336</u> | | NITRA pneumatic valve manifold, aluminum, 6 stations, (2) 3/8 in FNPT inlet port(s), (2) 3/8 in FNPT exhaust port(s). For use with AVS-33 series. | 0.9 |
| <u>AM-338</u> | | NITRA pneumatic valve manifold, aluminum, 8 stations, (2) 3/8 in FNPT inlet port(s), (2) 3/8 in FNPT exhaust port(s). For use with AVS-33 series. | 1.1 |
| <u>AM-33BP</u> | | NITRA blanking plate, plated steel. For use with AM-33 series manifolds. | 0.1 |
| <u>AM-514</u> | | NITRA pneumatic valve manifold, aluminum, 4 stations, (2) 1/4 in FNPT inlet port(s), (4) 1/4 in FNPT exhaust port(s). For use with AVS-51 series. | 0.6 |
| <u>AM-516</u> | | NITRA pneumatic valve manifold, aluminum, 6 stations, (2) 1/4 in FNPT inlet port(s), (4) 1/4 in FNPT exhaust port(s). For use with AVS-51 series. | 0.8 |
| <u>AM-518</u> | | NITRA pneumatic valve manifold, aluminum, 8 stations, (2) 1/4 in FNPT inlet port(s), (4) 1/4 in FNPT exhaust port(s). For use with AVS-51 series. | 1.1 |
| <u>AM-51BP</u> | | NITRA blanking plate, plated steel. For use with AM-51 series manifolds. | 0.1 |
| <u>AM-522</u> | | NITRA pneumatic valve manifold, aluminum, 2 stations, (2) 1/4 in FNPT inlet port(s), (4) 1/4 in FNPT exhaust port(s). For use with AVS-52 series. | 0.5 |
| <u>AM-524</u> | | NITRA pneumatic valve manifold, aluminum, 4 stations, (2) 1/4 in FNPT inlet port(s), (4) 1/4 in FNPT exhaust port(s). For use with AVS-52 series. | 0.9 |
| <u>AM-526</u> | | NITRA pneumatic valve manifold, aluminum, 6 stations, (2) 1/4 in FNPT inlet port(s), (4) 1/4 in FNPT exhaust port(s). For use with AVS-52 series. | 1.2 |
| <u>AM-528</u> | | NITRA pneumatic valve manifold, aluminum, 8 stations, (2) 1/4 in FNPT inlet port(s), (4) 1/4 in FNPT exhaust port(s). For use with AVS-52 series. | 1.5 |
| <u>AM-52BP</u> | | NITRA blanking plate, plated steel. For use with AM-52 series manifolds. | 0.1 |



Pneumatic Directional Control Solenoid Valve Manifolds and Accessories



AM-5 Series Manifolds



AM-31GS

| Pneumatic Directional Control Solenoid Valve Series Accessories Continued | | | |
|--|-------|---|-------------|
| Part No. | Price | Description | Weight (lb) |
| <u>AM-532</u> | | NITRA pneumatic valve manifold, aluminum, 2 stations, (2) 3/8 in FNPT inlet port(s), (4) 3/8 in FNPT exhaust port(s). For use with AVS-53 series. | 0.8 |
| <u>AM-534</u> | | NITRA pneumatic valve manifold, aluminum, 4 stations, (2) 3/8 in FNPT inlet port(s), (4) 3/8 in FNPT exhaust port(s). For use with AVS-53 series. | 1.4 |
| <u>AM-536</u> | | NITRA pneumatic valve manifold, aluminum, 6 stations, (2) 3/8 in FNPT inlet port(s), (4) 3/8 in FNPT exhaust port(s). For use with AVS-53 series. | 1.9 |
| <u>AM-538</u> | | NITRA pneumatic valve manifold, aluminum, 8 stations, (2) 3/8 in FNPT inlet port(s), (4) 3/8 in FNPT exhaust port(s). For use with AVS-53 series. | 2.5 |
| <u>AM-53BP</u> | | NITRA blanking plate, plated steel. For use with AM-53 series manifolds. | 0.1 |
| <u>AM-542</u> | | NITRA pneumatic valve manifold, aluminum, 2 stations, (2) 1/2 in FNPT inlet port(s), (4) 1/2 in FNPT exhaust port(s). For use with AVS-54 series. | 1.7 |
| <u>AM-544</u> | | NITRA pneumatic valve manifold, aluminum, 4 stations, (2) 1/2 in FNPT inlet port(s), (4) 1/2 in FNPT exhaust port(s). For use with AVS-54 series. | 2.8 |
| <u>AM-546</u> | | NITRA pneumatic valve manifold, aluminum, 6 stations, (2) 1/2 in FNPT inlet port(s), (4) 1/2 in FNPT exhaust port(s). For use with AVS-54 series. | 4.0 |
| <u>AM-548</u> | | NITRA pneumatic valve manifold, aluminum, 8 stations, (2) 1/2 in FNPT inlet port(s), (4) 1/2 in FNPT exhaust port(s). For use with AVS-54 series. | 5.2 |
| <u>AM-54BP</u> | | NITRA blanking plate, plated steel. For use with AM-54 series manifolds. | 0.1 |
| <u>AM-31GS</u> | | NITRA manifold mounting set, for use with AM-31 series manifolds. | 0.1 |
| <u>AM-32GS</u> | | NITRA manifold mounting set, for use with AM-32 series manifolds. | 0.1 |
| <u>AM-33GS</u> | | NITRA manifold mounting set, for use with AM-33 series manifolds. | 0.1 |
| <u>AM-51GS</u> | | NITRA manifold mounting set, for use with AM-51 series manifolds. | 0.1 |
| <u>AM-52GS</u> | | NITRA manifold mounting set, for use with AM-52 series manifolds. | 0.1 |
| <u>AM-53GS</u> | | NITRA manifold mounting set, for use with AM-53 series manifolds. | 0.1 |
| <u>AM-54GS</u> | | NITRA manifold mounting set, for use with AM-54 series manifolds. | 0.1 |



Pneumatic Directional Control Solenoid Valve Manifolds and Accessories

Dimensions

mm [inches]

AM 3x Series Manifolds

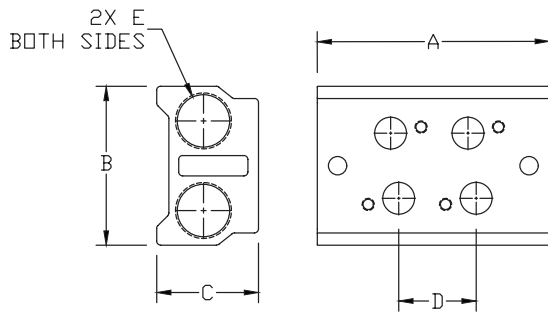

| MANIFOLD DIMENSIONS | | | | | |
|---------------------|--------------|-------------|-------------|----------------|---------|
| PART NO. | A | B | C | D | E |
| AM-312 | 57.0 [2.24] | 39.0 [1.54] | 25.0 [0.98] | 19.0 [0.75] | 1/4 NPT |
| AM-314 | 95.0 [3.74] | | | 3X 19.0 [0.75] | |
| AM-316 | 133.0 [5.24] | | | 5X 19.0 [0.75] | |
| AM-318 | 171.0 [6.73] | | | 7X 19.0 [0.75] | |
| AM-322 | 69.0 [2.72] | 45.0 [1.77] | 25.0 [0.98] | 23.0 [0.91] | |
| AM-324 | 115.0 [4.53] | | | 3X 23.0 [0.91] | |
| AM-326 | 161.0 [6.34] | | | 5X 23.0 [0.91] | |
| AM-328 | 207.0 [8.15] | | | 7X 23.0 [0.91] | |
| AM-332 | 82.0 [3.23] | 52.0 [2.05] | 29.0 [1.14] | 28.0 [1.10] | 3/8 NPT |
| AM-334 | 138.0 [5.46] | | | 3X 28.0 [1.10] | |
| AM-336 | 194.0 [7.64] | | | 5X 28.0 [1.10] | |
| AM-338 | 250.0 [9.84] | | | 7X 28.0 [1.10] | |

AM 5x Series Manifolds

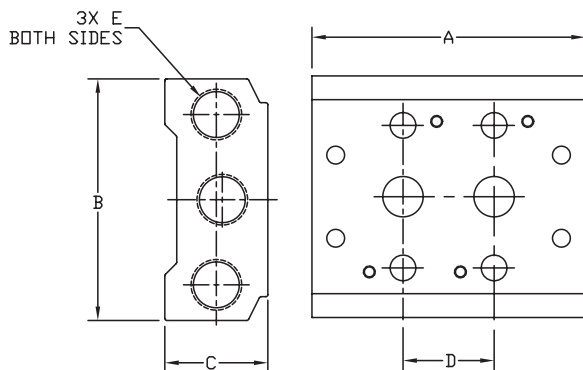

| MANIFOLD DIMENSIONS | | | | | |
|---------------------|---------------|--------------|-------------|-----------------|---------|
| PART NO. | A | B | C | D | E |
| AM-512 | 57.0 [2.24] | 58.0 [2.28] | 25.0 [0.98] | 19.0 [0.75]* | 1/4 NPT |
| AM-514 | 95.0 [3.74] | | | 3X 19.0 [0.75]* | |
| AM-516 | 133.0 [5.24] | | | 5X 19.0 [0.75]* | |
| AM-518 | 171.0 [6.73] | | | 7X 19.0 [0.75]* | |
| AM-522 | 69.0 [2.72] | 61.0 [2.40] | 26.0 [1.02] | 23.0 [0.91] | |
| AM-524 | 115.0 [4.53] | | | 3X 23.0 [0.91] | |
| AM-526 | 161.0 [6.34] | | | 5X 23.0 [0.91] | |
| AM-528 | 207.0 [8.15] | | | 7X 23.0 [0.91] | |
| AM-532 | 82.0 [3.23] | 75.0 [2.95] | 30.0 [1.19] | 28.0 [1.10] | 3/8 NPT |
| AM-534 | 138.0 [5.46] | | | 3X 28.0 [1.10] | |
| AM-536 | 194.0 [7.64] | | | 5X 28.0 [1.10] | |
| AM-538 | 250.0 [9.84] | | | 7X 28.0 [1.10] | |
| AM-542 | 98.0 [3.86] | 104.0 [4.09] | 38.0 [1.50] | 35.0 [1.38] | |
| AM-544 | 168.0 [6.61] | | | 3X 35.0 [1.38] | |
| AM-546 | 238.0 [9.37] | | | 5X 35.0 [1.38] | |
| AM-548 | 308.0 [12.13] | | | 7X 35.0 [1.38] | |

* Exhaust holes have 1mm offset from spacing centerline.

See our website www.AutomationDirect.com for complete Engineering drawings.

Solenoid Valve Cables and Connectors



These high quality connectors and over-molded cables help reduce wiring time. The lower voltage models, 24 V or 110 V AC/DC, include built-in surge suppression, Yellow LED indicator and are rated for connecting with electronics. The 230 V AC/DC models are rated for straight wired products. All models are available in five sizes based on DIN 43650.

Features

- 8 mm, 9.4 mm, 10 mm, 11 mm and 18 mm square DIN styles
- Fits most popular solenoid valves and sensors
- Suppression and LED indication available in 24 V or 110 V AC/DC models
- PVC jacketed cables in 1, 3 or 5 meter lengths on select connectors
- Field wireable connectors on select models
- Polarity insensitive (follow solenoid, sensor, or other devices wiring diagram)



8mm Connectors

Dimensions shown
mm [inches]

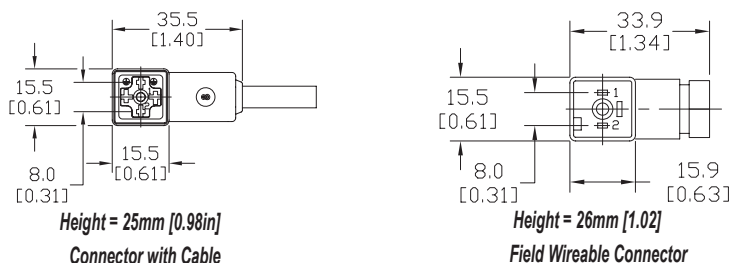
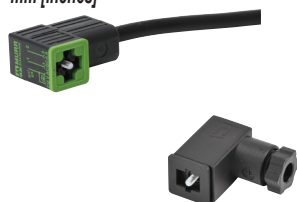

| 8mm (3-pole) Connectors (per DIN 43650 Form C) | | | | | | | | | | | | |
|--|-------|-----------------|----------------|-----------|---|--|-----|---------------------------------|---------------|--|--------------|--------------------|
| Part No. | Price | Voltage (AC/DC) | Current Rating | IP Rating | Wire Size | Cable Dia. (in.) | LED | Surge Protection | Wiring Figure | Screw Size/Torque | Weight (lbs) | Agency Approval |
| SC8-LS24-3 | | 24 ±20% | max 4 A | 67 | 18 AWG | 0.23 | yes | zener diode (D-Z DO-15 47V 2 W) | 1 | m2.5-0.45 x 25 mm / 0.4 Nm (3.5 in lb) | 0.40 | CSA (080128-0-000) |
| SC8-LS24-5 | 0.65 | | | | | | | | | | | |
| SC8-LS110-3 | | 110 ±10% | max 6 A | 65 | Solid 12 AWG Stranded 14 AWG w/Ferrule 16 AWG | field wireable gland size 0.20 to 0.24 | no | none | 7 | m2.5-0.45 x 25 mm / 0.5 Nm (4.4 in lb) | 0.41 | |
| SC8-LS110-5 | 0.63 | | | | | | | | | | | |
| SC8-3 | | 230 | max 6 A | 67 | 18 AWG | 0.23 | no | none | 2 | m2.5-0.45 x 25 mm / 0.5 Nm (4.4 in lb) | 0.39 | none |
| SC8-0 | 9 | | | | | | | | 0.10 | | | |
| SC8-1 | 2 | | | | | | | | 0.10 | | | |
| SC8-5 | 2 | | | | | | | | 0.68 | | | |

Last digit in part number denotes cable length in meters, a 0 indicates field termination.

8mm Transmitter Connector

Dimensions shown
mm [inches]

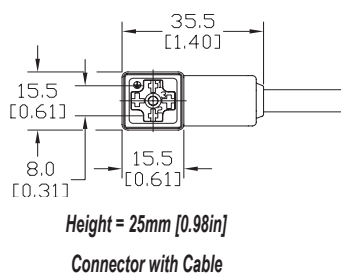

| 8mm (4-pole) Connectors (per DIN 43650 Form C) | | | | | | | | | | | | |
|--|-------|-----------------|----------------|-----------|-----------|------------------|-----|------------------|---------------|-------------------------------------|--------------|--------------------|
| Part No. | Price | Voltage (AC/DC) | Current Rating | IP Rating | Wire Size | Cable Dia. (in.) | LED | Surge Protection | Wiring Figure | Screw Size/Torque | Weight (lbs) | Agency Approval |
| SC8-5T | | 230 | max 6 A | 67 | 18 AWG | 0.26 | yes | none | 8 | m3-0.5 x 42 mm / 0.5 Nm (4.4 in lb) | 0.80 | CSA (080128-0-000) |

Last numeric digit in part number denotes cable length in meters, a 0 indicates field termination.

Solenoid Valve Cables and Connectors

9.4mm Connectors

Dimensions shown
mm [inches]

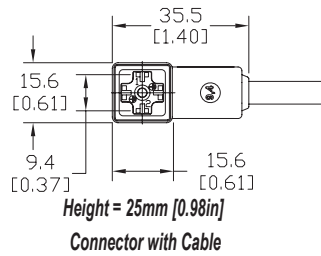

| 9.4mm (3-pole) Connectors (DIN Style, Form C Industrial) | | | | | | | | | | | | | |
|--|-------|-----------------|----------------|-----------|-----------|------------------|-----|-----------------------------------|---------------|-------------------------------------|--------------|--------------------|------|
| Part No. | Price | Voltage (AC/DC) | Current Rating | IP Rating | Wire Size | Cable Dia. (in.) | LED | Surge Protection | Wiring Figure | Screw Size/Torque | Weight (lbs) | Agency Approval | |
| SC9-LS24-3 | | 24 ±20% | max 4 A | 67 | 18 AWG | 0.23 | yes | zener diode (D-Z DO-15 47V 2 W) | 1 | m3-0.5 x 26 mm / 0.4 Nm (3.5 in lb) | 0.40 | CSA (080128-0-000) | |
| SC9-LS24-5 | | | | | | | | zener diode (D-Z DO-41 ZY200 2 W) | 7 | | 0.64 | | |
| SC9-LS110-3 | | 110 ±10% | max 6 A | | | | no | none | 2 | m3-0.5 x 26 mm / 0.5 Nm (4.4 in lb) | 0.40 | | none |
| SC9-LS110-5 | | | | | | | | | | | 0.64 | | |
| SC9-3 | | 230 | max 6 A | | | | no | none | 2 | m3-0.5 x 26 mm / 0.5 Nm (4.4 in lb) | 0.40 | none | |
| SC9-5 | | | | | | | | | | | 0.64 | | |

9.4mm Connectors

Dimensions shown
mm [inches]

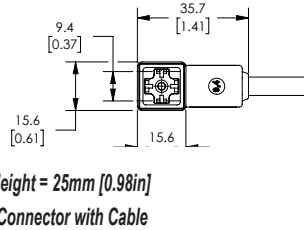

| 9.4mm (4-pole) Connectors (DIN Style, Form C Industrial) | | | | | | | | | | | | | |
|--|-------|-----------------|----------------|-----------|-----------|------------|--------------|-----|------------------|---------------|-------------------------------------|--------------|--------------------------|
| Part No. | Price | Voltage (AC/DC) | Current Rating | IP Rating | Wire Size | Cable Dia. | Cable Length | LED | Surge Protection | Wiring Figure | Screw Size/Torque | Weight (lbs) | Agency Approval |
| 7000-94141-6270300 | | 230 VAC/VDC | max 6 A | IP67 | 18 AWG | 5.6-6.2 mm | 9.8ft/3m | no | none | 8 | m3-0.5 x 26 mm / 0.4 Nm (3.5 in lb) | 0.50 | CSA (080128-0-000)/ RoHS |
| 7000-94141-6270500 | | | | | | | 16.4ft/5m | | | | | 0.79 | |

Solenoid Valve Cables and Connectors

10mm Connectors

Dimensions shown
mm [inches]

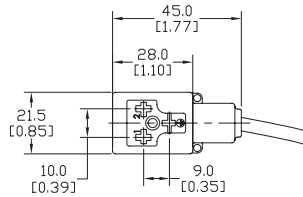

Height = 30mm [1.18in]

Connector with Cable

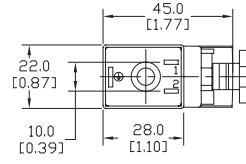

Height = 41mm [1.61in]

Field Wireable Connector

| 10mm (3-pole) Connectors (per DIN 43650 Form B) | | | | | | | | | | | | | | | |
|---|-------|-----------------|----------------|-----------|---|--|-----|---------------------------------|---------------|-------------------------------------|--------------|--------------------|------|---------------------|------|
| Part No. | Price | Voltage (AC/DC) | Current Rating | IP Rating | Wire Size | Cable Dia. (in.) | LED | Surge Protection | Wiring Figure | Screw Size/Torque | Weight (lbs) | Agency Approval | | | |
| SC10-LS24-3 | | 24 ±20% | max 4 A | 67 | 18 AWG | 0.23 | yes | zener diode (D-Z DO-15 47V 2 W) | 10 | m3-0.5 x 30 mm / 0.4 Nm (3.5 in lb) | 0.43 | CSA (080128-0-000) | | | |
| SC10-LS24-5 | | | | | | | | | | | | | | | 0.68 |
| SC10-LS110-3 | | 110 ±10% | max 4 A | | | | | | | | | | | | 0.43 |
| SC10-LS110-5 | | | | | | | | | | | | | | | 0.68 |
| SC10-3 | | 230 | max 10 A | | | | | | | | no | | none | 3 | 0.43 |
| SC10-5 | | | | | | | | | | | | | | | 0.68 |
| SC10-LS24-0 | | 24 ±20% | max 4 A | 65 | Solid 12 AWG Stranded 14 AWG w/Ferrule 16 AWG | field wireable gland size 0.24 to 0.32 | yes | zener diode (D-Z DO-15 47V 2 W) | 4 | m3-0.5 x 42 mm / 0.5 Nm (4.4 in lb) | 0.07 | none | | | |
| SC10-LS110-0 | | 110 ±10% | max 1 A | | | | | | | | | | | mov (SIOV S10 K130) | 5 |

Last digit in part number denotes cable length in meters, a 0 indicates field termination.

11mm Connectors

Dimensions shown
mm [inches]

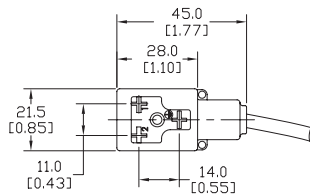

Height = 30mm [1.18in]

Connector with Cable

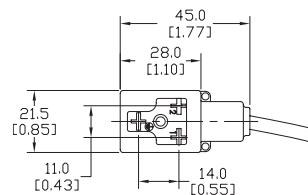

Height = 30mm [1.18in]

Reverse Connector with Cable

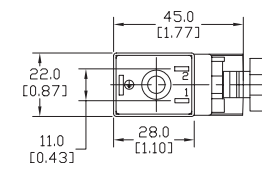

Height = 41mm [1.61in]

Field Wireable Connector

| 11mm (3-pole) Connectors (DIN Style, Form B Industrial) | | | | | | | | | | | | | | | | |
|---|-------|-----------------|----------------|-----------|---|--|-----|---------------------------------|---------------|-------------------------------------|--------------|--------------------|----|---------------------|------|------|
| Part No. | Price | Voltage (AC/DC) | Current Rating | IP Rating | Wire Size | Cable Dia. (in.) | LED | Surge Protection | Wiring Figure | Screw Size/Torque | Weight (lbs) | Agency Approval | | | | |
| SC11-LS24-3 | | 24 ±20% | max 4 A | 67 | 18 AWG | 0.23 | yes | zener diode (D-Z DO-15 47V 2 W) | 10 | m3-0.5 x 30 mm / 0.4 Nm (3.5 in lb) | 0.44 | CSA (080128-0-000) | | | | |
| SC11-LS24-5 | | | | | | | | | | | | | | | | 0.67 |
| SC11-LS110-3 | | 110 ±10% | max 4 A | | | | | | | | | | | | | 0.44 |
| SC11-LS110-5 | | | | | | | | | | | | | | | | 0.67 |
| SC11-LS24-3R | | 24 ±20% | max 4 A | | | | | | | | | | | | 0.44 | |
| SC11-LS24-5R | | | | | | | | | | | | | | | 0.67 | |
| SC11-LS110-3R | | 110 ±10% | max 4 A | | | | | | | 0.44 | | | | | | |
| SC11-LS110-5R | | | | | | | | | | 0.67 | | | | | | |
| SC11-3 | | 230 | max 10 A | | | | no | none | 3 | | 0.44 | | | | | |
| SC11-5 | | | | | | | | | | | 0.67 | | | | | |
| SC11-LS24-0 | | 24 ±20% | max 4 A | 65 | Solid 12 AWG Stranded 14 AWG w/Ferrule 16 AWG | field wireable gland size 0.24 to 0.32 | yes | zener diode (D-Z DO-15 47V 2 W) | 4 | m3-0.5 x 42 mm / 0.5 Nm (4.4 in lb) | 0.07 | none | | | | |
| SC11-LS110-0 | | 110 ±10% | max 1 A | | | | | | | | | | | mov (SIOV S10 K130) | 5 | 0.07 |
| SC11-0 | | 230 | max 10 A | | | | | | | | | | no | none | 9 | 0.07 |

Last numeric digit in part number denotes cable length in meters, a 0 indicates field termination.

Solenoid Valve Cables and Connectors Wiring Diagrams

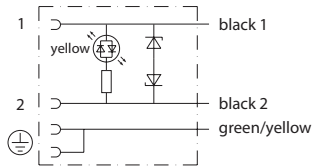

Figure No. 1

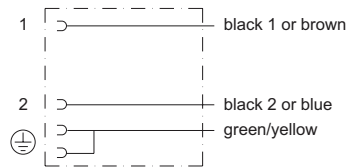

Figure No. 2

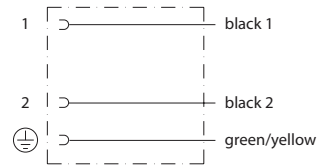

Figure No. 3

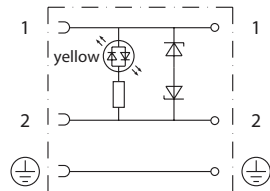

Figure No. 4

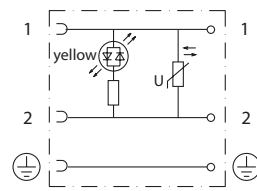

Figure No. 5

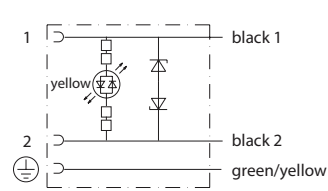

Figure No. 6

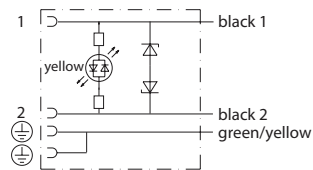

Figure No. 7

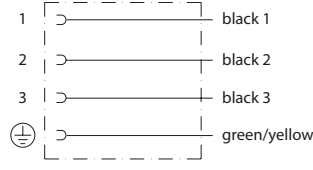

Figure No. 8

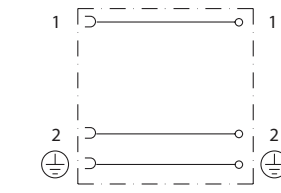

Figure No. 9

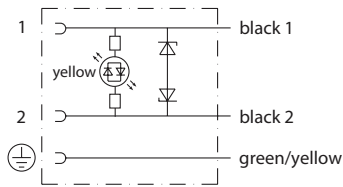

Figure No. 10



Exhaust Silencers

NITRA™ exhaust silencers are available in three styles and nine popular NPT and BSPT sizes. Add these to the exhaust ports of pneumatic directional control valves to reduce noise.

Features

- Inch and metric sizes available
- Bronze cone and flat styles
- Plastic cylindrical
- Maximum pressure = 150 psi (10 bar)



SBC Series



SBF Series



SPL Series

SBC Silencers

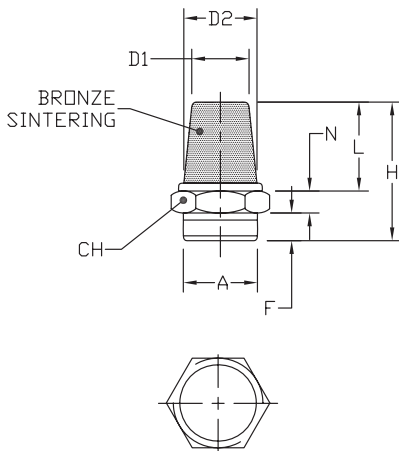

| NITRA™ Bronze Cone Silencers | | | | | | | | | | | |
|--|-------|----------|-------------|-------------|-------------|-------------|-------------|-------------|-------------|---------------------|---------------|
| Inch Sizes - dimensions in inches [mm] | | | | | | | | | | | |
| Part No. | Price | A | CH | D1 | D2 | F | H | L | N | Package Weight (lb) | Qty. per pack |
| SBC-18N | | MNPT 1/8 | 0.47 [12.0] | 0.32 [8.0] | 0.28 [7.0] | 0.24 [6.0] | 0.94 [24.0] | 0.55 [14.0] | 0.16 [4.0] | 0.01 | 2 |
| SBC-14N | | MNPT 1/4 | 0.63 [16.0] | 0.47 [12.0] | 0.40 [10.0] | 0.32 [8.0] | 1.18 [30.0] | 0.71 [18.0] | 0.16 [4.0] | 0.01 | |
| SBC-38N | | MNPT 3/8 | 0.71 [18.0] | 0.55 [14.0] | 0.39 [11.0] | 0.35 [9.0] | 1.38 [35.0] | 0.83 [21.0] | 0.197 [5.0] | 0.05 | |
| SBC-12N | | MNPT 1/2 | 0.94 [24.0] | 0.75 [19.0] | 0.59 [15.0] | 0.40 [10.0] | 1.73 [44.0] | 1.10 [28.0] | 0.24 [6.0] | 0.15 | |
| Metric Sizes - dimensions in inches [mm] | | | | | | | | | | | |
| SBC-M5 | | M5 | 0.31 [8.0] | 0.20 [5.0] | 0.16 [4.0] | 0.20 [5.0] | 0.79 [20.0] | 0.47 [12.0] | 0.12 [3.0] | 0.01 | 2 |
| SBC-18R | | R 1/8 | 0.47 [12.0] | 0.32 [8.0] | 0.28 [7.0] | 0.24 [6.0] | 0.94 [24.0] | 0.55 [14.0] | 0.16 [4.0] | 0.01 | |
| SBC-14R | | R 1/4 | 0.63 [16.0] | 0.47 [12.0] | 0.40 [10.0] | 0.32 [8.0] | 1.18 [30.0] | 0.71 [18.0] | 0.16 [4.0] | 0.01 | |
| SBC-38R | | R 3/8 | 0.71 [18.0] | 0.55 [14.0] | 0.39 [11.0] | 0.35 [9.0] | 1.38 [35.0] | 0.83 [21.0] | 0.197 [5.0] | 0.05 | |
| SBC-12R | | R 1/2 | 0.94 [24.0] | 0.75 [19.0] | 0.59 [15.0] | 0.40 [10.0] | 1.73 [44.0] | 1.10 [28.0] | 0.24 [6.0] | 0.15 | |

Flow Characteristics

Bronze Cone Silencers

- A: SBC-M5
- B: SBC-18N; SBC-18R
- C: SBC-14N; SBC-14R
- D: SBC-38N; SBC-38R
- E: SBC-12N; SBC-12R

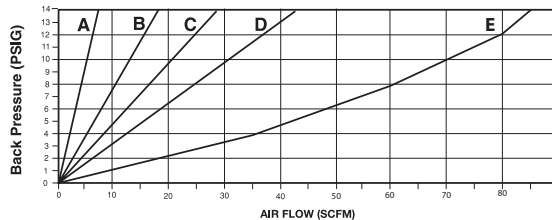

Noise Elimination = > 20db
Filtered Element = 40 micron

SBF Silencers

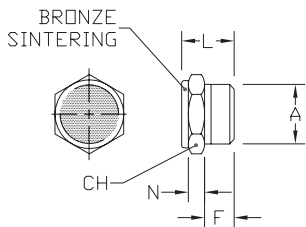

| NITRA™ Bronze Flat Silencers | | | | | | | | | |
|--|-------|----------|-------------|-------------|-------------|------------|---------------------|---------------|--|
| Inch Sizes - dimensions in inches [mm] | | | | | | | | | |
| Part No. | Price | A | CH | F | L | N | Package Weight (lb) | Qty. per pack | |
| SBF-18N | | MNPT 1/8 | 0.47 [12.0] | 0.24 [6.0] | 0.47 [12.0] | 0.16 [4.0] | 0.01 | 2 | |
| SBF-14N | | MNPT 1/4 | 0.67 [17.0] | 0.32 [8.0] | 0.59 [15.0] | 0.16 [4.0] | 0.01 | | |
| SBF-38N | | MNPT 3/8 | 0.75 [19.0] | 0.35 [9.0] | 0.67 [17.0] | 0.20 [5.0] | 0.05 | | |
| SBF-12N | | MNPT 1/2 | 0.94 [24.0] | 0.40 [10.0] | 0.71 [18.0] | 0.24 [6.0] | 0.15 | | |
| Metric Sizes - dimensions in inches [mm] | | | | | | | | | |
| SBF-M5 | | M5 | 0.31 [8.0] | 0.20 [5.0] | 0.35 [9.0] | 0.12 [3.0] | 0.01 | 2 | |
| SBF-18R | | R 1/8 | 0.47 [12.0] | 0.24 [6.0] | 0.47 [12.0] | 0.16 [4.0] | 0.01 | | |
| SBF-14R | | R 1/4 | 0.67 [17.0] | 0.32 [8.0] | 0.59 [15.0] | 0.16 [4.0] | 0.01 | | |
| SBF-38R | | R 3/8 | 0.75 [19.0] | 0.35 [9.0] | 0.67 [17.0] | 0.20 [5.0] | 0.05 | | |
| SBF-12R | | R 1/2 | 0.94 [24.0] | 0.40 [10.0] | 0.71 [18.0] | 0.24 [6.0] | 0.15 | | |



Exhaust Silencers

Flow Characteristics

Bronze Flat Silencers

- A: SBF-M5
- B: SBF-18N; SBF-18R
- C: SBF-14N; SBF-14R
- D: SBF-28N; SBF-38R
- E: SBF-12N; SBF-12R

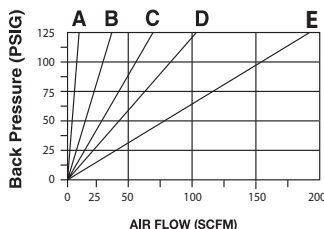

Noise Elimination = > 30db
 Filtered Element = 40 micron

SPL Silencers

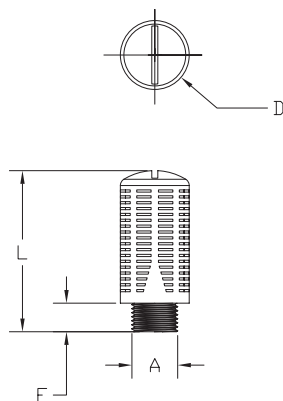

Note: SPL series plastic exhaust silencers have a maximum pressure of 80 PSI (5.5 bar).

| NITRA™ Plastic Exhaust Silencers | | | | | | | |
|--|-------|----------|-------------|-------------|-------------|----------------------|---------------|
| Inch Sizes - dimensions in inches [mm] | | | | | | | |
| Part No. | Price | A | D | L | F | Package Weight (lbs) | Qty. per pack |
| SPL-18N | | MNPT 1/8 | 0.55 [13.8] | 1.28 [32.4] | 0.33 [8.3] | 0.02 | 2 |
| SPL-14N | | MNPT 1/4 | 0.68 [17.3] | 1.68 [42.5] | 0.39 [9.9] | 0.03 | |
| SPL-38N | | MNPT 3/8 | 0.87 [22.0] | 2.10 [53.4] | 0.40 [10.0] | 0.06 | |
| SPL-12N | | MNPT 1/2 | 1.00 [25.4] | 2.66 [67.6] | 0.44 [11.1] | 0.08 | |
| Metric Sizes - dimensions in inches [mm] | | | | | | | |
| SPL-18R | | R 1/8 | 0.60 [15.2] | 1.33 [33.7] | 0.24 [6.1] | 0.02 | 2 |
| SPL-14R | | R 1/4 | 0.60 [18.8] | 1.60 [40.6] | 0.31 [7.7] | 0.03 | |
| SPL-38R | | R 3/8 | 0.94 [24.0] | 2.20 [55.9] | 0.39 [9.9] | 0.06 | |
| SPL-12R | | R 1/2 | 0.94 [24.0] | 2.20 [55.9] | 0.39 [9.9] | 0.08 | |

Flow Characteristics

Plastic Silencers

- A: SPL-18N; SPL-18R
- B: SPL-14N; SPL-14R
- C: SPL-38N; SPL-38R
- D: SPL-12N; SPL-12R

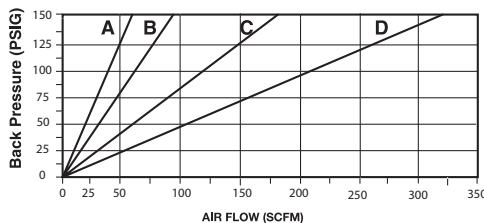

Noise Elimination = > 30db
 Filtered Element = 40 micron