

# IDEM Inch Hinge Safety Switches

## Inch Hinge Series Housing

- Shaft hinge (Idem Inch Hinge) interlock operated
- M16, M20, 1/2 in NPT threaded opening or M12 connection
- 16.5mm to 18mm mounting profile (Inch-X); 16.5mm to 22mm mounting profile (MK-1)
- 25mm plastic, 30mm stainless steel housings

- Compact body
- Plastic and stainless steel housings
- 90° adjustable head
- Force guided N.C. contacts

See electrical specifications later in this section.

### IDEM Inch Hinge Series



IDEM Inch Hinge Safety Switches									
Part Number	Price	Body Material	Head Material	Weight (lb)	Actuator Travel / Force for Positive Opening	Contact Configuration	Shaft Size	Connection	Dimensions
<a href="#">HC-1-193001</a>		Plastic	316 stainless steel	0.29	7° / 0.5N	2 N.C. Slow action	Solid diameter 10 x 80mm	1 x M16	Figure 1
<a href="#">HC-1-193002</a>		Plastic	316 stainless steel	0.32	7° / 0.5N	2 N.C. Slow action	Solid diameter 10 x 80mm	M12 Quick disconnect	Figure 1
<a href="#">HC-1-193007</a>		Plastic	316 stainless steel	0.29	7° / 0.5N	2 N.C. Slow action	Hollow diameter 16 x 30mm	1 x M16	Figure 1
<a href="#">HC-1-193008</a>		Plastic	316 stainless steel	0.32	7° / 0.5N	2 N.C. Slow action	Hollow diameter 16x 30mm	M12 Quick disconnect	Figure 1

## Dimensions

mm [in]

Figure 1  
HC-1

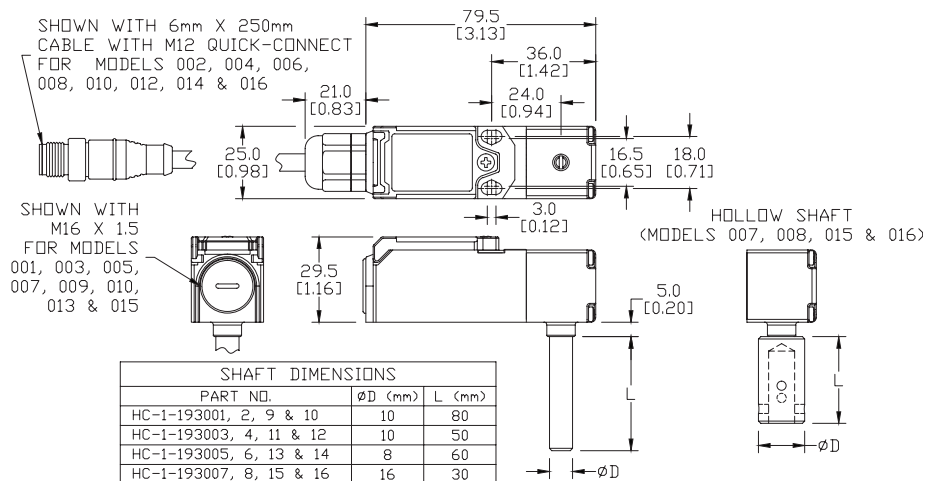

# IDEM Interlock Safety Switches Specifications



Specifications							
	IDIS	INCH/MK1	HC	KM	KP/K-SS	K-15	GLx
<b>Safety Classification and Reliability Data</b>							
<b>Switching Reliability (B10<sub>d</sub>)</b>	2.5 x 10 <sup>6</sup> operations at 100 mA load						1.5 x 10 <sup>6</sup> operations at 100 mA load
<b>ISO 13849-1</b>	Up to PLe depending upon system architecture						
<b>EN 62061</b>	Up to SIL3 depending upon system architecture						
<b>Safety Data—Annual Usage</b>	8 cycles per hour / 24 hours per day / 365 days						
<b>Agency Approvals</b>	cULus (E258676), CE						cULus (E258676), CE, TUV
<b>Electrical and General Specifications</b>							
<b>Conductor Sizes</b>	16-12 AWG (1.5 to 2.5 mm <sup>2</sup> )						
<b>Utilization Category</b>	AC15, A300, 3 A						
<b>Thermal Current</b>	10A						
<b>Short Circuit Overload Protection</b>	External 10A Fast Acting recommended						
<b>Rated Insulation Voltage</b>	600 VAC			500 VAC			
<b>Contact Terminals</b>	Stainless steel (Snap action plated brass); Max conductor 1.5 m <sup>2</sup> (IDIS), 2.5 m <sup>2</sup> (KM, K/K-15); 1 N•m [0.74 lb•ft] torque						
<b>Maximum Switching Current</b>	2.5A @24 VDC 6A @ 120 VAC, 3A @ 240 VDC (720 VA Break)						
<b>Maximum Approach/Withdrawal Speed</b>	600 mm/s [23.6 in/s]						NA
<b>Enclosure Protection</b>	IP67 (IP69K on all models with both stainless steel head and body)						
<b>Operating Temperature</b>	-25 to 80 °C [-13 to 176 °F]						
<b>Vibration</b>	IEC 68-2-6, 10 Hz to 55 Hz + 1 Hz						10 Hz to 500 Hz 0.35mm [0.014in]
<b>Lid Screws/Torque</b>	Plated brass 1 N•m [0.74 lb•ft]	Stainless steel T20 Torx 1 N•m [0.74 lb•ft]	Stainless steel 1 N•m [0.74 lb•ft]				Stainless steel T20 Torx 1.5 N•m [1.11 lb•ft]
<b>Recommended Mounting Screws/Torque</b>	M4 1.5 N•m [1.11 lb•ft]	M5 4 N•m [2.95 lb•ft]	M4 1.5 N•m [1.11 lb•ft]		M5 4 N•m [2.95 lb•ft]		
<b>Head Screws/Torque</b>	Stainless steel, except snap (plated brass) 1 N•m [0.74 lb•ft]	Stainless steel T20 Torx 1 N•m [0.74 lb•ft]	Stainless steel; 1 N•m [0.74 lb•ft]				

# IDEM Interlock/Hinge Safety Travel Charts



## Interlock Safety Switch Types

### Slow-make/slow-break contacts:

A contact element in which the contact motion is dependent on the actuator speed.

### Snap-action contact:

A contact element in which the contact motion is independent of the speed of the actuator. This feature ensures reliable electrical performance even in applications involving very slow moving actuators.

## Contacts Configuration

### 1 N.O. and 2 N.C.

Slow-make/slow-break contacts

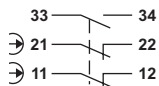

### 3 N.C.

Slow-make/slow-break contacts

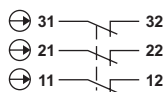

### 1 N.O. and 1 N.C.

Snap action contacts

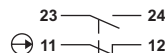

### 1 N.O. and 3 N.C.

Slow-make/slow-break contacts

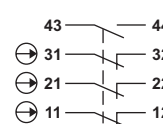

### 1 N.O. and 1 N.C.

Slow-make/slow-break contacts

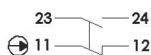

### 2 N.O. and 2 N.C.

Slow-make/slow-break contacts

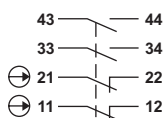

### 2 N.C.

Slow-make/slow-break contacts

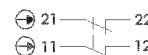

## Travel Charts



### Interlock Switches

2NC 1NO 6.8 6.0 0 mm

11/12	Open	
21/22	Open	
33/34		Open

3NC 6.0 0 mm

11/12	Open	
21/22	Open	
31/32	Open	

3NC 1NO 6.8 6.0 0 mm

11/12	Open	
21/22	Open	
31/32	Open	
43/44		Open

2NC 2NO 6.8 6.0 0 mm

11/12	Open	
21/22	Open	
33/34		Open
43/44		Open

1NC 1NO (SNAP) 6.5 0 mm

11/12	Open	
23/24		Open

### Hinge Switch

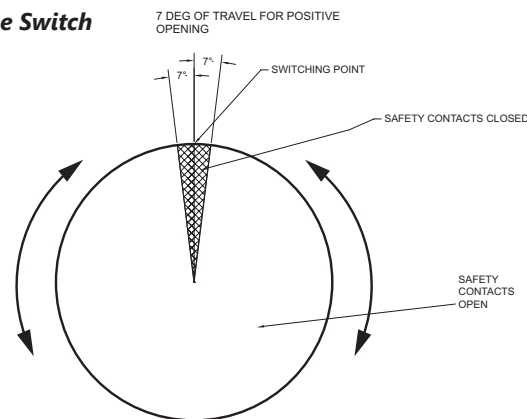

SHAFT CAN FREELY TURN WITH NO DEAD STOPS.

User to ensure that by correct positioning of the shaft at installation causes the safety contacts to open such that no hazard exists to the operator when the door is opened a few degrees.

### Safety Rope Switches

0 mm      3.5 mm      14.5 mm      17.0 mm

EX	1 N.O./2 N.C.	1 N.O./3 N.C.	2 N.O./2 N.C.	Latched off - Rope Slack	Tension Range (Switch Reset)	Rope Pulled
N.C.	11/12	11/12	11/12	Open		Open
	21/22	21/22	21/22	Open		Open
		31/32		Open		Open
N.O.	33/34	43/44	33/44		Open	
			43/44		Open	

# Safety Products



*Warning: Safety products sold by AutomationDirect are Safety components only. The purchaser/installer is solely responsible for the application of these components and ensuring all necessary steps have been taken to assure each application and use meets all performance and applicable safety requirements and/or local, national and/or international safety codes as required by the application. AutomationDirect cannot certify that our products, used solely or in conjunction with other AutomationDirect or other vendors' products, will assure safety for any application. Any person using or applying any products sold by AutomationDirect is responsible for learning the safety requirements for their individual application and applying them, and therefore assumes all risks, and accepts full and complete responsibility, for the selection and suitability of the product for their respective application.*

*AutomationDirect does not provide design or consulting services, and cannot advise whether any specific application or use of our products would ensure compliance with the safety requirements for any application.*