

# Fuji Duo Series TK-E Overload Relays

TK-E series thermal overload relays with open-phase protective device

## Features

- This relay protects motor windings from burning due to overloads, locked rotor current, or open-phases
- Maintenance and inspection safety has been improved by employing a finger protection mechanism to cover exposed terminals (conforms to DIN 57106, VDE 0106 Teil 100)
- Isolated NO and NC contacts can be used with different potentials
- A high-precision scale for the current adjustment dial enables easy and exact current setting
- The operating status can be visually checked with ease
- The relays can be manually tripped. A trip-free mechanism is also provided
- Base unit can be added to enable separate mounting of the TK-E02, E2, and E3-xxx models



TK-E02-900



TK-E3-5000



TK-E2-800



TK-E5-3600



## Standards

UL listed, file E44592, Standard UL 508  
 cUL listed, file E44592, CSA C22.2 No. 14  
 IEC 60947-4-1, EN60947-4-1  
 VDE 0660, JIS C 8201-4-1  
 CE Compliant



TK-E6-6500

| TK-E Series Overloads |       |                               |  |
|-----------------------|-------|-------------------------------|--|
| Part Number           | Price | Amperage Adjustment Range (A) | Frame Width/Contactor  |
| TK-E02-15             | <-->  | 0.1 - 0.15                    | 53mm<br>SC-E02(G) through SC-E05(G)<br>For separate mounting, use with optional base unit SZ-HCE on page 17-26 |
| TK-E02-20             | <-->  | 0.13 - 0.2                    |  |
| TK-E02-24             | <-->  | 0.15 - 0.24                   |  |
| TK-E02-30             | <-->  | 0.2 - 0.3                     |  |
| TK-E02-36             | <-->  | 0.24 - 0.36                   |  |
| TK-E02-54             | <-->  | 0.36 - 0.54                   |  |
| TK-E02-72             | <-->  | 0.48 - 0.72                   |  |
| TK-E02-96             | <-->  | 0.64 - 0.96                   |  |
| TK-E02-120            | <-->  | 0.8 - 1.2                     |  |
| TK-E02-145            | <-->  | 0.95 - 1.45                   |  |
| TK-E02-220            | <-->  | 1.4 - 2.2                     |  |
| TK-E02-260            | <-->  | 1.7 - 2.6                     |  |
| TK-E02-340            | <-->  | 2.2 - 3.4                     |  |
| TK-E02-420            | <-->  | 2.8 - 4.2                     |  |
| TK-E02-600            | <-->  | 4.0 - 6.0                     |  |
| TK-E02-800            | <-->  | 5.0 - 8.0                     |  |
| TK-E02-900            | <-->  | 6.0 - 9.0                     |  |
| TK-E02-1100           | <-->  | 7.0 - 11.0                    |  |
| TK-E02-1300           | <-->  | 9.0 - 13.0                    |  |
| TK-E02-1800           | <-->  | 12 - 18                       |  |
| TK-E02-2200           | <-->  | 16 - 22                       |  |
| TK-E02-2500           | <-->  | 20 - 25                       |  |

| TK-E Series Overloads (continued) |       |                               |   |
|-----------------------------------|-------|-------------------------------|---|
| Part Number                       | Price | Amperage Adjustment Range (A) | Frame Width/Contactor   |
| TK-E2-600                         | <-->  | 4 - 6                         | 54mm<br>SC-E1(G) through SC-E2S(G)<br>For separate mounting, use with optional base unit SZ-HDE on page 17-26 |
| TK-E2-800                         | <-->  | 5 - 8                         |   |
| TK-E2-900                         | <-->  | 6 - 9                         |   |
| TK-E2-1100                        | <-->  | 7 - 11                        |   |
| TK-E2-1300                        | <-->  | 9 - 13                        |   |
| TK-E2-1800                        | <-->  | 12 - 18                       |   |
| TK-E2-2600                        | <-->  | 18 - 26                       |   |
| TK-E2-3600                        | <-->  | 24 - 36                       |   |
| TK-E2-4200                        | <-->  | 32 - 42                       |   |
| TK-E2-5000                        | <-->  | 40 - 50                       |   |
| TK-E2-5400                        | <-->  | 44 - 54                       |   |
| TK-E3-1100                        | <-->  | 7 - 11                        | 68mm<br>SC-E3(G) through SC-E4(G)<br>For separate mounting, use with optional base unit SZ-HEE on page 17-24  |
| TK-E3-1300                        | <-->  | 9 - 13                        |   |
| TK-E3-1800                        | <-->  | 12 - 18                       |   |
| TK-E3-2600                        | <-->  | 18 - 26                       |   |
| TK-E3-3600                        | <-->  | 24 - 36                       |   |
| TK-E3-4000                        | <-->  | 28 - 40                       |   |
| TK-E3-5000                        | <-->  | 34 - 50                       |   |
| TK-E3-6500                        | <-->  | 45 - 65                       |   |
| TK-E3-6800                        | <-->  | 48 - 68                       |   |
| TK-E3-8000                        | <-->  | 64 - 80                       |   |

| TK-E Series Overloads (continued) |       |                               |                       |                         |
|-----------------------------------|-------|-------------------------------|-----------------------|-------------------------|
| Part Number                       | Price | Amperage Adjustment Range (A) | Frame Width/Contactor |                         |
| TK-E5-2600                        | <-->  | 18 - 26                       | 76.5mm<br>SC-E5       |                         |
| TK-E5-3600                        | <-->  | 24 - 36                       |                       |                         |
| TK-E5-4000                        | <-->  | 28 - 40                       |                       |                         |
| TK-E5-5000                        | <-->  | 34 - 50                       |                       |                         |
| TK-E5-6500                        | <-->  | 45 - 65                       |                       |                         |
| TK-E5-9500                        | <-->  | 65 - 95                       |                       |                         |
| TK-E5-10500                       | <-->  | 85 - 105                      |                       |                         |
| TK-E6-6500                        | <-->  | 45 - 65                       |                       | 100mm<br>SC-E6<br>SC-E7 |
| TK-E6-8000                        | <-->  | 53 - 80                       |                       |                         |
| TK-E6-9500                        | <-->  | 65 - 95                       |                       |                         |
| TK-E6-12500                       | <-->  | 85 - 125                      |                       |                         |
| TK-E6-16000                       | <-->  | 110 - 160                     |                       |                         |

# Fuji Duo Series Contactor and Overload Relay Selection Tables

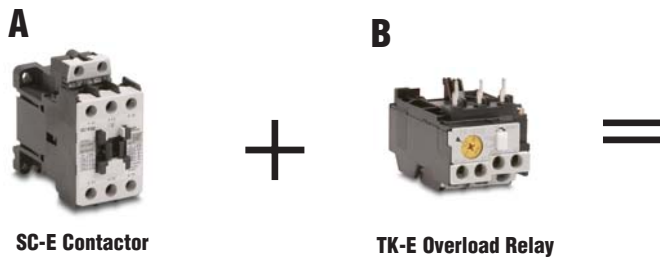

## 100-240V Single Phase Motor (1/3 to 25 hp)

Step 1. Select a contactor from page 17-5 based on motor voltage and horsepower.

Step 2. Select an overload relay from page 17-21 based on motor full load current.

Check the data plate on the motor for the hp, volts and full-rated amps.

| Motor  |      |             |      |         |
|--------|------|-------------|------|---------|
| HP     | 5    | Volts       | 460  | Phase 3 |
| Type   | P    | Amps        | 7.6  | Hz 60   |
| RPM    | 1725 | Insul Class | F    | SF 1.15 |
| Design | B    | Encl        | TEFC | Code K  |
| Duty   | Cont | Encl        | TEFC | Code K  |

Motor horsepower

Motor voltage

Motor full-load rated amperage (FLA)

## Three Phase Motors - Refer to tables on following page

Step 1. Select a SC-E contactor from Column A based on motor voltage, and horsepower.

Step 2. Select a TK-E overload relay from Column B to work with the SC-E contactor selected in Step 1. The motor full load current (FLA) should be within the adjustable current range of the overload relay.

# Fuji Duo Series Overload Relay Selection Tables

## 220-240V 3-Phase Motor (0.5 to 50 hp)<sup>1</sup>

| Overload Relay Selection for 220–240V 3-phase motors |   |             |                |                          |
|--|---|-------------|----------------|--------------------------|
| Motor Rating   |   | A           | B              |                          |
| Motor HP   | Motor Full Load Amperage (FLA) <sup>2</sup> | Contactor   | Overload Relay |                          |
|  |   |             | Part Number    | Adjustable Current Range |
| 1/2  | 2.2   | SC-E02-xxxx | TK-E02-260     | 1.7 to 2.6 Amps          |
| 3/4  | 3.5   |             | TK-E02-420     | 2.8 to 4.2 Amps          |
| 1  | 4.2   |             | TK-E02-600     | 4 to 6 Amps              |
| 1-1/2  | 6   |             | TK-E02-800     | 5 to 8 Amps              |
| 2  | 6.8   |             | TK-E02-900     | 6 to 9 Amps              |
| 3  | 9.6   | SC-E03-xxxx | TK-E02-1300    | 9 to 13 Amps             |
| 5  | 15.2  | SC-E04-xxxx | TK-E02-1800    | 12 to 18 Amps            |
| 7-1/2  | 22  | SC-E05-xxxx | TK-E02-2500    | 20 to 25 Amps            |
| 10   | 28  | SC-E1-xxxx  | TK-E2-3600     | 24 to 36 Amps            |
| 15   | 42  | SC-E2-xxxx  | TK-E2-4200     | 32 to 42 Amps            |
| 20   | 54  | SC-E3-xxxx  | TK-E3-6500     | 45 to 65 Amps            |
| 25   | 68  | SC-E4-xxxx  | TK-E3-6800     | 48 to 68 Amps            |
| 30   | 80  | SC-E5-xxxx  | TK-E5-9500     | 65 to 95 Amps            |
| 40   | 104   | SC-E6-xxxx  | TK-E6-12500    | 85 to 125 Amps           |
| 50   | 130   | SC-E7-xxxx  | TK-E6-16000    | 110 to 160 Amps          |

**Note 1:** For 220-240 V three-phase motors up to 150 hp refer to the Fuji Odyssey series.  
**Note 2:** Per NEC 2005 table 430.250

## 440-480V 3-Phase Motor (0.5 to 100 hp)<sup>1</sup>

| Overload Relay Selection for 440–480V 3-phase motors |   |             |                |                          |
|--|---|-------------|----------------|--------------------------|
| Motor Rating   |   | A           | B              |                          |
| Motor HP   | Motor Full Load Amperage (FLA) <sup>2</sup> | Contactor   | Overload Relay |                          |
|  |   |             | Part Number    | Adjustable Current Range |
| 1/2  | 1.1   | SC-E02-xxxx | TK-E02-145     | 0.95 to 1.45 Amps        |
| 3/4  | 1.6   | SC-E02-xxxx | TK-E02-220     | 1.4 to 2.2 Amps          |
| 1  | 2.1   | SC-E02-xxxx | TK-E02-260     | 1.7 to 2.6 Amps          |
| 1-1/2  | 3.0   | SC-E02-xxxx | TK-E02-420     | 2.8 to 4.2 Amps          |
| 2  | 3.4   | SC-E02-xxxx | TK-E02-420     | 2.8 to 4.2 Amps          |
| 3  | 4.8   | SC-E02-xxxx | TK-E02-600     | 4 to 6 Amps              |
| 5  | 7.6   | SC-E02-xxxx | TK-E02-900     | 6 to 9 Amps              |
| 7 1/2  | 11  | SC-E03-xxxx | TK-E02-1300    | 9 to 13 Amps             |
| 10   | 14  | SC-E04-xxxx | TK-E02-1800    | 12 to 18 Amps            |
| 15   | 21  | SC-E05-xxxx | TK-E02-2500    | 20 to 25 Amps            |
| 20   | 27  | SC-E1-xxxx  | TK-E2-3600     | 24 to 36 Amps            |
| 25   | 34  | SC-E1-xxxx  | TK-E2-4200     | 32 to 42 Amps            |
| 30   | 40  | SC-E2-xxxx  | TK-E2-4200     | 32 to 42 Amps            |
| 40   | 52  | SC-E3-xxxx  | TK-E3-6500     | 45 to 65 Amps            |
| 50   | 65  | SC-E5-xxxx  | TK-E3-6800     | 48 to 68 Amps            |
| 60   | 77  | SC-E5-xxxx  | TK-E5-9500     | 65 to 95 Amps            |
| 75   | 96  | SC-E6-xxxx  | TK-E6-12500    | 85 to 125 Amps           |
| 100  | 124   | SC-E7-xxxx  | TK-E6-16000    | 110 to 160 Amps          |

**Note 1:** For 440-480 V three-phase motors up to 300 hp refer to the Fuji Odyssey series.  
**Note 2:** Per NEC 2005 table 430.250

Company Info.

PLCs

Field I/O

Software

C-more & other HMI

AC Drives

AC Motors

Power Transmiss.

Steppers/Servos

Motor Controls

Proximity Sensors

Photo Sensors

Limit Switches

Encoders

Current Sensors

Pressure Sensors

Temp. Sensors

Pushbuttons/Lights

Process

Relays/Timers

Comm.

Terminal Blocks & Wiring

Power

Circuit Protection

Enclosures

Tools

Appendix

Part Index

# Fuji Duo Series TK-E Overload Relays



| Standard Operating Conditions |   |
|-------------------------------|---|
| <b>Ambient Temperature</b>    | Operating: -5 to 55°C<br>No sudden temperature changes resulting in condensation or icing<br>(The average temperature over a 24-hour period must not exceed 35°C)<br>Storage: -40 to 65°C |
| <b>Humidity</b>               | 45 to 85%RH   |
| <b>Atmosphere</b>             | No excessive dust, smoke, corrosive gases, flammable gases, steam, or salt  |
| <b>Vibration</b>              | 10 to 55Hz, 15m/s <sup>2</sup>  |
| <b>Shock</b>                  | 50m/s <sup>2</sup>  |

| Specifications |                                    |                   |                          |                        |                                 |  |
|----------------|------------------------------------|-------------------|--------------------------|------------------------|---------------------------------|--|
| Model          | Applicable Contactor Non-reversing | Auxiliary Contact | Trip Class IEC 60947-4-1 | No. of Heater Elements | Power Consumption per Pole (VA) | Features   |
| TK-E02-xxx     | SC-E02, E03, E04, E05-xxx          | 1NO+1NC           | 10A                      | 3                      | 2.2                             | Overload, open-phase protection,<br>Ambient temperature compensation,<br>Manual/auto reset selectable,<br>Manual trip mechanism,<br>Trip indicator |
| TK-E2-xxx      | SC-E1, E2, E2S-xxx                 |                   |                          |                        | 3.8                             |  |
| TK-E3-xxx      | SC-E3, E4-xxx                      |                   |                          |                        | 6.6                             |  |
| TK-E5-xxx      | SC-E5-xxx                          |                   |                          |                        | 6.6                             |  |
| TK-E6-xxx      | SC-E6, E7-xxx                      |                   |                          |                        | 8.0                             |  |

| Auxiliary Contact Ratings - UL and CSA |                              |                                  |           |             |             |                    |
|--|------------------------------|----------------------------------|-----------|-------------|-------------|--------------------|
| Model                                  | Rated Insulation Voltage (V) | NEMA ICS 5-2000 Ratings (note 1) |           |             |             |                    |
|  |                              | AC Ratings                       |           |             | DC Ratings  |                    |
|  |                              | Designation                      | Making VA | Breaking VA | Designation | Making/Breaking VA |
| TK-E02-xxx to TK-E6-xxx                | 690                          | B600                             | 3600      | 360         | R300        | 28                 |

**Notes:**  
1. NEMA ICS 5-2000. For more information, refer to Control Circuit Contact Electrical Ratings, page 16-75.

| Auxiliary contact ratings - JIS and IEC |                              |                           |                               |                  |                |                  |                             |
|---|------------------------------|---------------------------|-------------------------------|------------------|----------------|------------------|-----------------------------|
| Model                                   | Rated Insulation Voltage (A) | Rated Thermal Current (A) | Rated Operational Current (A) |                  |                |                  | Minimum Voltage and Current |
|   |                              |                           | AC Voltage (V)                | AC15 (Ind. load) | DC Voltage (V) | DC13 (Ind. load) |                             |
| TK-E02-xxx                              | 690                          | 5                         | 24                            | 3 (0.3) *        | 24             | 1.1 (0.3)        | 3VDC, 5mA                   |
|   |                              |                           | 100-120                       | 2.5 (0.3) *      | 100-120        | 0.28             |                             |
|   |                              |                           | 200-240                       | 2 (0.3) *        | 200-240        | 0.14             |                             |
|   |                              |                           | 380-440                       | 1 (0.3) *        |                |                  |                             |
|   |                              |                           | 500-600                       | 0.6 (0.3) *      |                |                  |                             |
| TK-E2-xxx                               | 690                          | 5                         | 24                            | 3 (0.5) *        | 24             | 1.1 (0.3)        | 3VDC, 5mA                   |
| TK-E3-xxx                               |                              |                           | 100-120                       | 2.5 (0.5) *      | 100-120        | 0.28             |                             |
| TK-E5-xxx                               |                              |                           | 200-240                       | 2 (0.5) *        | 200-240        | 0.14             |                             |
| TK-E6-xxx                               |                              |                           | 380-440                       | 1 (0.5) *        |                |                  |                             |
|   |                              |                           | 500-600                       | 0.6 (0.5) *      |                |                  |                             |

**Note:** \* In case of auto-reset type NO contact.

# Fuji Duo Series TK-E Overload Relays

## Wiring



Be sure to wire the relays correctly using the wiring diagrams on the supplied installation sheets. Main terminals for models TK-E02-xxx to TK-E6-xxx are wired using solid wires or stranded wires. Stranded wires or flexible stranded wires can be connected by twisting them together and crimping a sleeve (ferrule) onto them before connecting.



## Tightening torque

If wires are not tightened sufficiently, they may become hot or loosen and result in a fire, short-circuit, electric shock, or some other potentially dangerous situation. Be sure to tighten the wires to the torques specified in these tables.



| Wire Sizes, Tightening Torques - Main Circuit   |   |   |   |           |
|---|---|---|---|-----------|
| Thermal Overload Relay Model  | TK-E2-xxx   | TK-E3-xxx   | TK-E5-xxx   | TK-E6-xxx |
| Single Stranded Wire (mm <sup>2</sup> )   | 0.75 to 16  | 1.5 to 35   |   | 16 to 70  |
| Flexible Stranded Wire with Sleeve (mm <sup>2</sup> )   | 0.75 to 16  | 1.5 to 35   |   | 16 to 70  |
| Flexible Stranded Wire without Sleeve (mm <sup>2</sup> )  | 0.75 to 16  | 1.5 to 35   |   | 16 to 70  |
| AWG   | 6 max.  | 2 max.  |   | 00 max.   |
| Insulation Stripping Length   |  |  |  |           |
| Tool  | Phillips screwdriver, H-type, No. 2 (ISO 8764);<br>ADC part number DN-SP1 or DN-SP2 |   | Hex. wrench 4 (ISO 2936)  |           |
|   | Flat-blade screwdriver, 1 x 5.5 x L-type, B (ISO 2830);<br>ADC part number DN-SS5   |   |   |           |
| Tightening Torque (N·m)   | 2.5   | 6   |   | 10        |
| <i>Note: Stranded wire (0 to 25mm<sup>2</sup>) consists of 7 wires or less. Stranded wire (35 to 120mm<sup>2</sup>) consists of 19 wires or less. Flexible stranded wire consists of more wires than the above.</i> |   |   |   |           |

| Wire Sizes, Tightening Torques - Main Circuit |  |
|---|--|
| Thermal Overload Relay Type                   | TK-E02-xxx   |
| Solid Wire (mm <sup>2</sup> )                 | One 0.75 to 4  |
|   | Two 1 to 4   |
| Stranded Wire (mm <sup>2</sup> )              | One 0.75 to 4  |
|   | Two 1 to 4   |
| AWG   | One 12 max.  |
|   | Two 12 max.  |
| Insulation Stripping Length (mm)              |   |
| Terminal Screw Size                           | M4   |
| Tool  | Phillips screwdriver, H-type, No. 2 (ISO 8764);<br>ADC part number DN-SP1 or DN-SP2<br>Flat-blade screwdriver, 1 x 5.5 x L-type, B (ISO 2830);<br>ADC part number DN-SS5 |
| Tightening Torque [N·m (lb·in)]               | 1.2 to 1.5 (11 to 13)  |

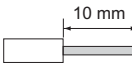
| Wire Sizes, Tightening Torques - Control Circuit |  |
|--|--|
| Single Stranded Wire (mm <sup>2</sup> )          | One 0.75 to 2.5 (ø 1 to ø 1.6)   |
|  | Two 0.75 to 2.5  |
| AWG  | One 18 to 14   |
|  | Two 18 to 14   |
| Insulation Stripping Length (mm)                 |   |
| Fork Terminal                                    | Max. 7.7mm wide (R2-3.5)   |
| Terminal Screw Size                              | M3.5   |
| Tool   | Phillips screwdriver, H-type, No. 2 (ISO 8764);<br>ADC part number DN-SP1 or DN-SP2<br>Flat-blade screwdriver, 1 x 5.5 x L-type, B (ISO 2830);<br>ADC part number DN-SS5 |
| Tightening Torque [N·m (lb·in)]                  | 0.8 to 1 (7 to 9)  |

# Fuji Duo Series TK-E Overload Relays

## Operating characteristics

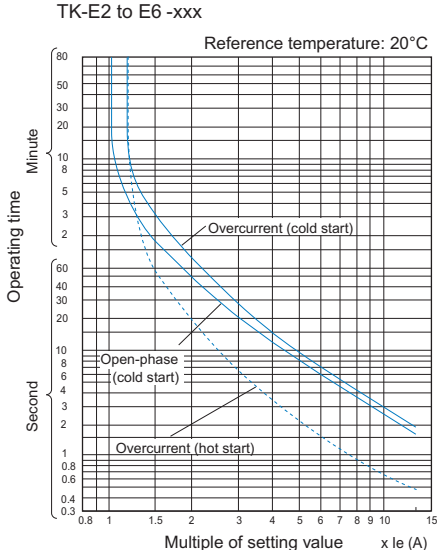
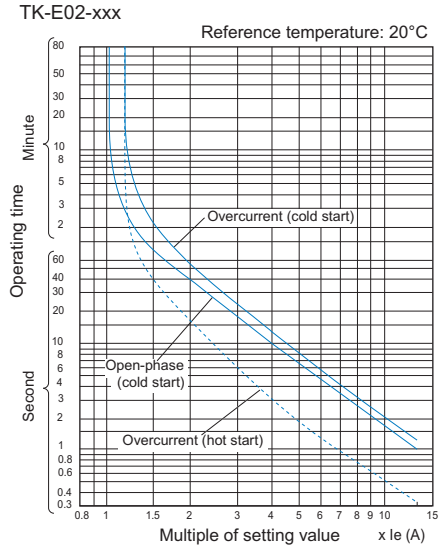

## Optional accessories

### Base units for separate mounting

Allows TK-E02, E2, and E3 series thermal overload relays to be separately mounted to 35mm wide DIN rail, or screw mounted to panel.

| Mounting Base Unit |                            |       |
|--------------------|----------------------------|-------|
| Part Number        | Applicable Overload Relays | Price |
| SZ-HCE             | TK-E02-xxx                 | <---> |
| SZ-HDE             | TK-E2-xxx                  | <---> |
| SZ-HEE             | TK-E3-xxx                  | <---> |

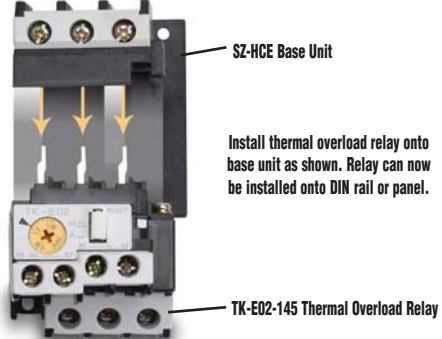

SZ-HCE

SZ-HCE

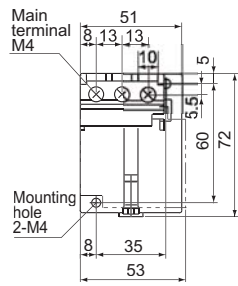
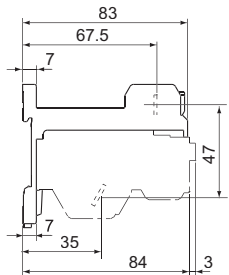

SZ-HDE

SZ-HDE

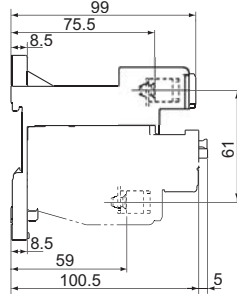

SZ-HEE

SZ-HEE

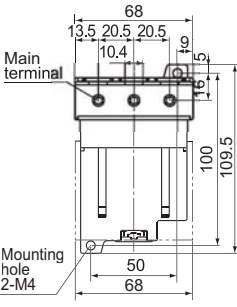
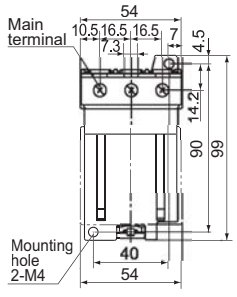
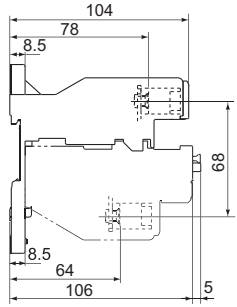

# Fuji Duo Series TK-E Overload Relays

## Dimensions (mm)

### Overload relays

#### TK-E02-xxx

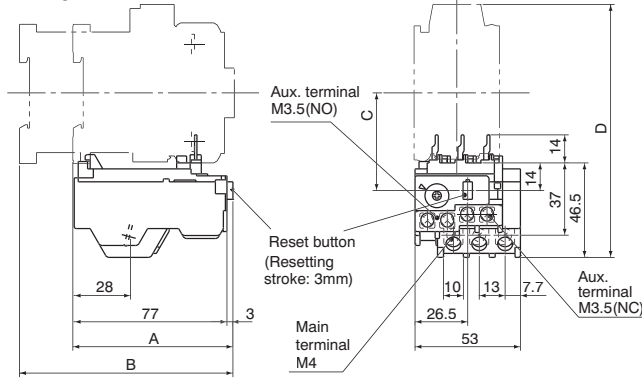

| Contactor      | A    | B     | C  | D     |                |
|----------------|------|-------|----|-------|----------------|
| SC-E02 to 05   | 80.5 | -     | 49 | 127.5 | Weight: 0.13kg |
| SC-E02G to 05G | -    | 107.5 | 49 | 127.5 |                |

#### TK-E3-xxx

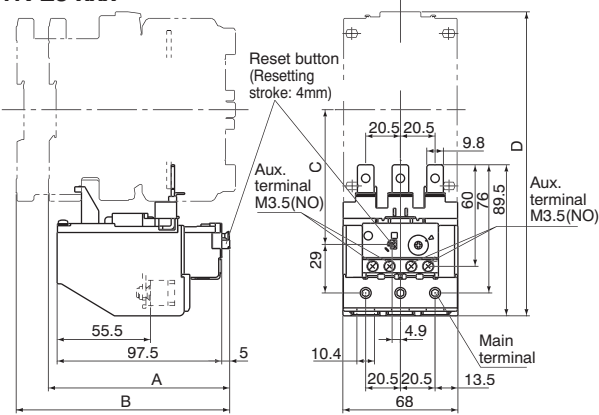

| Contactor  | A     | B     | C    | D   |                |
|------------|-------|-------|------|-----|----------------|
| SC-E3, E4  | 107.5 | -     | 79.5 | 180 | Weight: 0.34kg |
| SC-E3, E4G | -     | 126.5 | 79.5 | 180 |                |

#### TK-E6-xxx

On-contactor mounting only

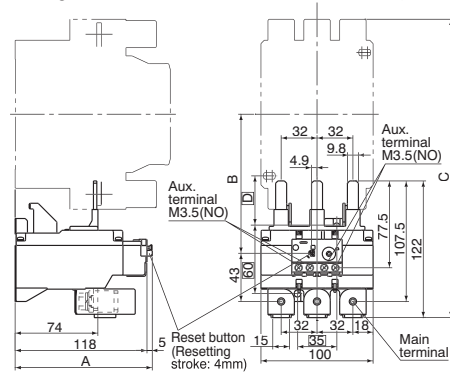

| Contactor | A   | B   | C     | D  |                |
|-----------|-----|-----|-------|----|----------------|
| SC-E6     | 123 | 124 | 266.5 | 45 | Weight: 0.71kg |
| SC-E7     | 123 | 129 | 274   | 50 |                |

#### TK-E2-xxx

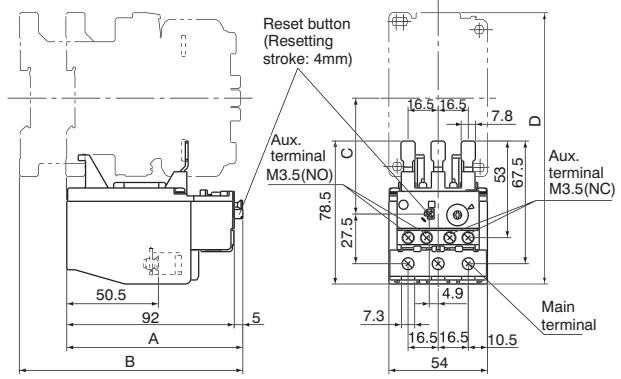

| Contactor      | A  | B   | C    | D   |                |
|----------------|----|-----|------|-----|----------------|
| SC-E1 to E2S   | 97 | -   | 63.5 | 149 | Weight: 0.25kg |
| SC-E1G to E2SG | -  | 123 | 63.5 | 149 |                |

#### TK-E5-xxx

On-contactor mounting only

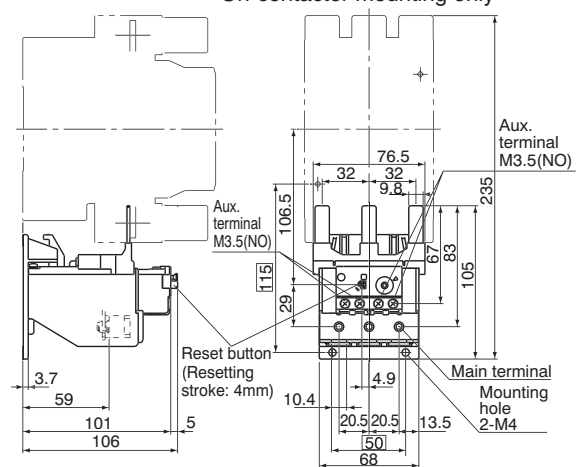

Weight: 0.37kg

## Wiring diagram

### 3-heater element

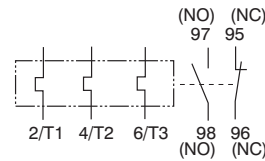

Company Info.

PLCs

Field I/O

Software

C-more & other HMI

AC Drives

AC Motors

Power Transmiss.

Steppers/Servos

Motor Controls

Proximity Sensors

Photo Sensors

Limit Switches

Encoders

Current Sensors

Pressure Sensors

Temp. Sensors

Pushbuttons/Lights

Process

Relays/Timers

Comm.

Terminal Blocks & Wiring

Power

Circuit Protection

Enclosures

Tools

Appendix

Part Index