

# Industrial strength cooling options for your enclosure from AutomationDirect

## Heat Exchangers

- For NEMA 4 and 4X enclosures
- Closed loop cooling
- Energy efficient: uses approximately the same power as a filtered fan system
- 120VAC and 24VDC models available
- UL
- Made in the USA



## Air Conditioning Units

- For NEMA 12, 4, 4X type enclosures
- Digital temperature controller
- Active condensate evaporation system
- High unit efficiency
- Tough industrial construction
- Compressor protection system



## Enclosure Vortex Coolers

- For NEMA 12, 4, 4X type enclosures
- Operates on compressed air
- Stainless steel construction
- No moving parts, no maintenance required
- Vortex coolers can be "resized" for changing applications by simply replacing the generator inside the cooler. No need to purchase a new unit
- Replacing the vortex generator takes minutes



## Seifert Thermoelectric Cooling Units

- For NEMA 4, 4X, and 12 enclosures
- Stainless steel housing
- 170, 340, 510, 680 BTU/H cooling capacity
- Recessed mounting
- No maintenance required
- 24VDC and 120VAC power options



# Enclosure Air Conditioners



## Applications

Designed to maintain the temperature inside an electrical enclosure at or below a safe level for the enclosed equipment, while maintaining a closed loop environment inside the enclosure to keep out contaminants that can be in the ambient air. Can be used in environments such as steel, food processing, petrochemical, cement, paper/pulp and plastics industries, provided there are no corrosive gases or liquids that could damage internal components.

## Construction

- Free-standing rigid chassis for easy installation and maintenance
- All mounting hardware, full-size template and instruction manual included
- Power input terminal block on all models
- All Type 4 and 4X models come with condenser coils coated with an electrically applied corrosion-resistant coating

## Features

- Programmable temperature controller with visible alarm features in a 0.57 x 0.29in [14.5 x 7.3mm] panel
- 70°F to 95°F (20°C to 35°C) temperature control range
- 50°F to 125°F (10°C to 52°C) ambient temperature range
- Pre-wired for external alarm monitoring connections (22 AWG three-conductor cable, 7 ft (2.3 m) long)
- Active condensate evaporation system with safety overflow
- Protective coated condenser coils on NEMA 4 and 4X for corrosion resistance
- Thermal expansion valve for maximum efficiency over wide range of temperatures and loads
- Anti short-cycle compressor protection
- High and low refrigerant cut-outs with fault indication
- Highly energy-efficient compressors
- UL/cUL listed



TA10-060-26-12 shown



## Stratus Air Conditioners General Specifications

Part Number	Nominal Cooling Capacity	Operating Voltage	Inrush Current (A)	Running Current (A)	Recommended Fuse Size/Time Delay (A)	SCCR (A)	Connection	Refrigerant	Refrigerant Amount (oz)		
TA10-010-16-xx	1480 BTU/H	115VAC/60Hz	14.50	3.44	12	*	Spring terminal block 24-8 AWG	R134a	4.00		
TA10-010-26-xx		230VAC/60Hz	14.00	2.67	7	*					
TA20-010-48D-xx	1500 BTU/H	48VDC	-	3.50	8 (fast acting)	*			R134a	6.00	
TA20-010-16-xx	1690 BTU/H	115VAC/60Hz	10.10	2.70	5	*					
TA10-015-16-xx	1725 BTU/H	115VAC/60Hz	14.60	3.44	12	*				R134a	7.75
TA10-015-26-xx		230VAC/60Hz	13.30	2.67	7	*					
TA10-027-16-xx	2680 BTU/H	115VAC/60Hz	10.00	3.20	8	*		R134a			13.25
TA10-027-46-xx		460VAC/60Hz	2.64	0.80	2	*					
TA20-020-16-xx	2705 BTU/H	115VAC/60Hz	10.63	4.10	5	*			R422d		9.75
TA20-020-26-xx		230VAC/60Hz	8.84	2.00	4	*					
TA10-033-16-xx	3300 BTU/H	115VAC/60Hz	16.00	4.80	12	*				R422d	14.25
TA10-033-46-xx		460VAC/60Hz	16.00	1.30	3	*					
TA10-020-26-xx	3585 BTU/H	230VAC/60Hz	13.65	3.07	7	*	R422d	9.75			
TA10-040-26-xx	4000 BTU/H	230VAC/60Hz	13.41	3.07	6	*		13.25			
TA10-050-16-xx	4390 BTU/H	115VAC/60Hz	23.42	7.26	12	*	Spring terminal block 16-6 AWG	R422d	12.50		
TA10-050-26-xx		230VAC/60Hz	19.15	3.76	10	*					
TA10-050-46-xx		460VAC/60Hz	9.18	1.86	5	160kA					
TA10-045-16-xx	4535 BTU/H	115VAC/60Hz	32.30	6.82	12	*	Spring terminal block 24-8 AWG	R134a	14.00		
TA10-045-46-xx		460VAC/60Hz	7.74	1.70	3	*					
TA10-059-16-xx	5910 BTU/H	115VAC/60Hz	32.30	6.14	12	*	Spring terminal block 16-6 AWG	R422d	15.00		
TA10-060-16-xx	7580 BTU/H	115VAC/60Hz	42.41	7.83	25	*			R422d	18.00	
TA10-060-26-xx		230VAC/60Hz	21.15	4.80	12	*					
TA10-060-46-xx		460VAC/60Hz	10.13	1.80	5	160kA					

Note: \* Voltage variation no greater than  $\pm 10\%$  from nameplate rating and Frequency variation no greater than  $\pm 3\text{Hz}$  from nameplate rating.

# TA10 Series Enclosure Air Conditioners, Frame Size TA10-2



## NEMA 12 Construction

- Fabricated from 16-gauge cold-rolled steel
- ANSI 61 gray polyester powder coating inside and out
- Pre-cut mounting gasket included, to be field installed
- All mounting hardware, full-size template and instruction manual included
- Power input terminal block on all models

## NEMA 4 Construction

- Fabricated from 16-gauge cold-rolled steel
- ANSI 61 gray polyester powder coating inside and out
- Pre-cut mounting gasket installed for NEMA/UL type rating on all units
- All mounting hardware, full-size template and instruction manual included
- Power input terminal block on all models

## NEMA 4X Construction

- Fabricated from 16-gauge 304 stainless steel
- Pre-cut mounting gasket installed for NEMA/UL type rating on all units
- All mounting hardware, full-size template and instruction manual included
- Power input terminal block on all models

## Features

- Fits 12in deep enclosures that have smooth/flat sides. Check enclosure dimensions/specifications before ordering
- Protective coated condenser coils on NEMA 4 and 4X for corrosion resistance

## Listings

- UL File: SA33404
- UL 50, 12, 4, and
- Made in USA



TA10-020-26-4X

## TA10 Enclosure Air Conditioners, Frame Size TA10-2

NEMA 12	Price	Drawing Link	NEMA 4	Price	Drawing Link	NEMA 4X	Price	Drawing Link	Nominal Cooling Capacity (BTU/H)	Operating Voltage	Weight (lb)
<a href="#">TA10-027-16-12</a>		<a href="#">PDF</a>	<a href="#">TA10-027-16-04</a>		<a href="#">PDF</a>	<a href="#">TA10-027-16-4X</a>		<a href="#">PDF</a>	2680	115VAC/60Hz	65
<a href="#">TA10-027-46-12</a>		<a href="#">PDF</a>	<a href="#">TA10-027-46-04</a>		<a href="#">PDF</a>	<a href="#">TA10-027-46-4X</a>		<a href="#">PDF</a>		460VAC/60Hz	99
<a href="#">TA10-033-16-12</a>		<a href="#">PDF</a>	<a href="#">TA10-033-16-04</a>		<a href="#">PDF</a>	<a href="#">TA10-033-16-4X</a>		<a href="#">PDF</a>	3300	115VAC/60Hz	65
<a href="#">TA10-033-46-12</a>		<a href="#">PDF</a>	<a href="#">TA10-033-46-04</a>		<a href="#">PDF</a>	<a href="#">TA10-033-46-4X</a>		<a href="#">PDF</a>		460VAC/60Hz	99
<a href="#">TA10-020-26-12</a>		<a href="#">PDF</a>	<a href="#">TA10-020-26-04</a>		<a href="#">PDF</a>	<a href="#">TA10-020-26-4X</a>		<a href="#">PDF</a>	3585	230VAC/60Hz	72
<a href="#">TA10-040-26-12</a>		<a href="#">PDF</a>	<a href="#">TA10-040-26-04</a>		<a href="#">PDF</a>	<a href="#">TA10-040-26-4X</a>		<a href="#">PDF</a>	4000		
<a href="#">TA10-045-16-12</a>		<a href="#">PDF</a>	<a href="#">TA10-045-16-04</a>		<a href="#">PDF</a>	<a href="#">TA10-045-16-4X</a>		<a href="#">PDF</a>	4535	115VAC/60Hz	65
<a href="#">TA10-045-46-12</a>		<a href="#">PDF</a>	<a href="#">TA10-045-46-04</a>		<a href="#">PDF</a>	<a href="#">TA10-045-46-4X</a>		<a href="#">PDF</a>		460VAC/60Hz	99

Note: \* Voltage variation no greater than  $\pm 10\%$  from nameplate rating and Frequency variation no greater than  $\pm 3\text{Hz}$  from nameplate rating.

# TA10 Series Enclosure Air Conditioners, Frame Size TA10-2



## Air Conditioner Performance Curves

**TA10-027**

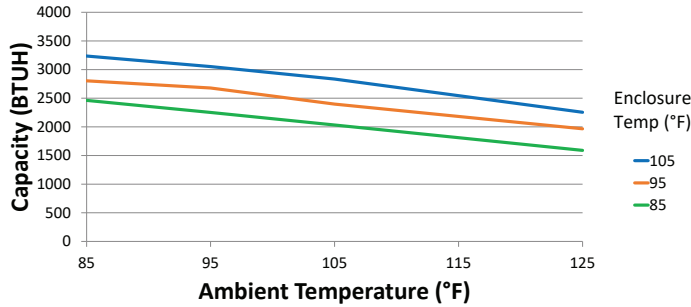

**TA10-020-26-xx**

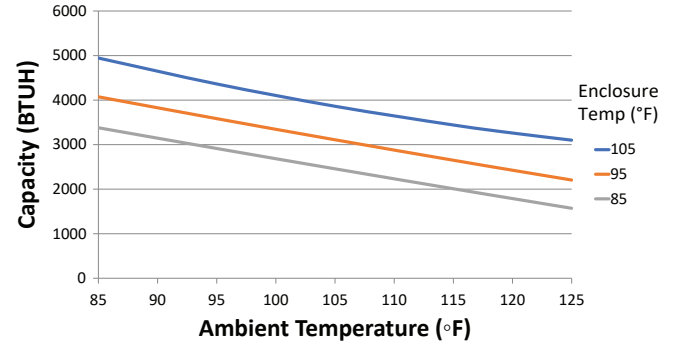

**TA10-033**

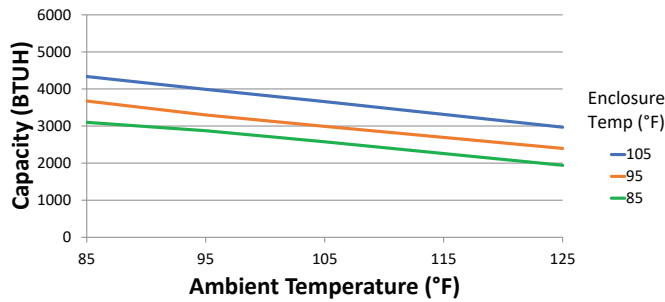

**TA10-040-26-XX**

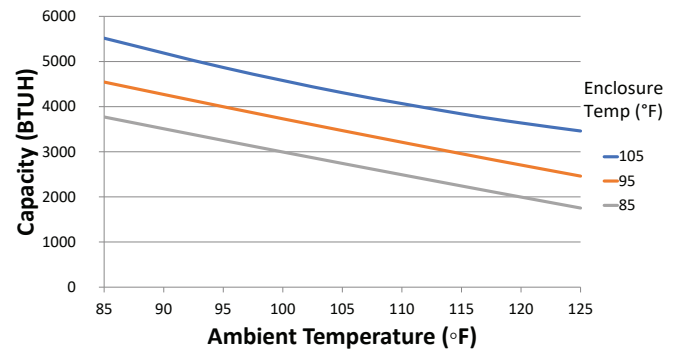

**TA10-045**

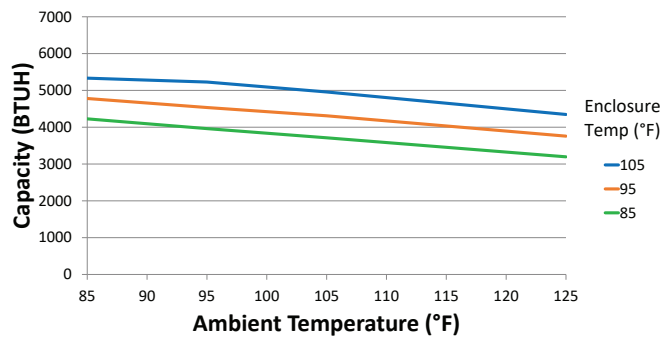

# Air Conditioners Filters

## Replacement Filters



Replacement filters are identical to the original filters supplied with the air conditioners. Clean/replace the filter regularly to keep the air conditioner working at its highest efficiency.

### Features

- 250 micron expanded aluminum filter element
- 60% filter efficiency
- Washable and reusable

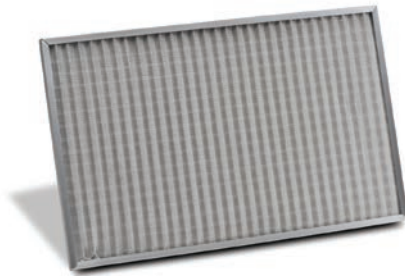

TA10-FILTER-3



TA20-FILTER-1

Air Conditioner Filters			
Part Number	Price	Description	Frame Size
<a href="#">TA10-FILTER-1</a>		Replacement filter for TA10 series air conditioning units, 1000 to 1500 BTU/H	TA10-1
<a href="#">TA10-FILTER-2</a>		Replacement filter for TA10 series air conditioning units, 2000 to 4000 BTU/H	TA10-2
<a href="#">TA10-FILTER-3</a>		Replacement filter for TA10 series air conditioning units, 5000 to 6000 BTU/H	TA10-3
<a href="#">TA20-FILTER-1</a>		Replacement filter for TA20 series air conditioning units, 2000 BTU/H	TA20-1

### Dimensions

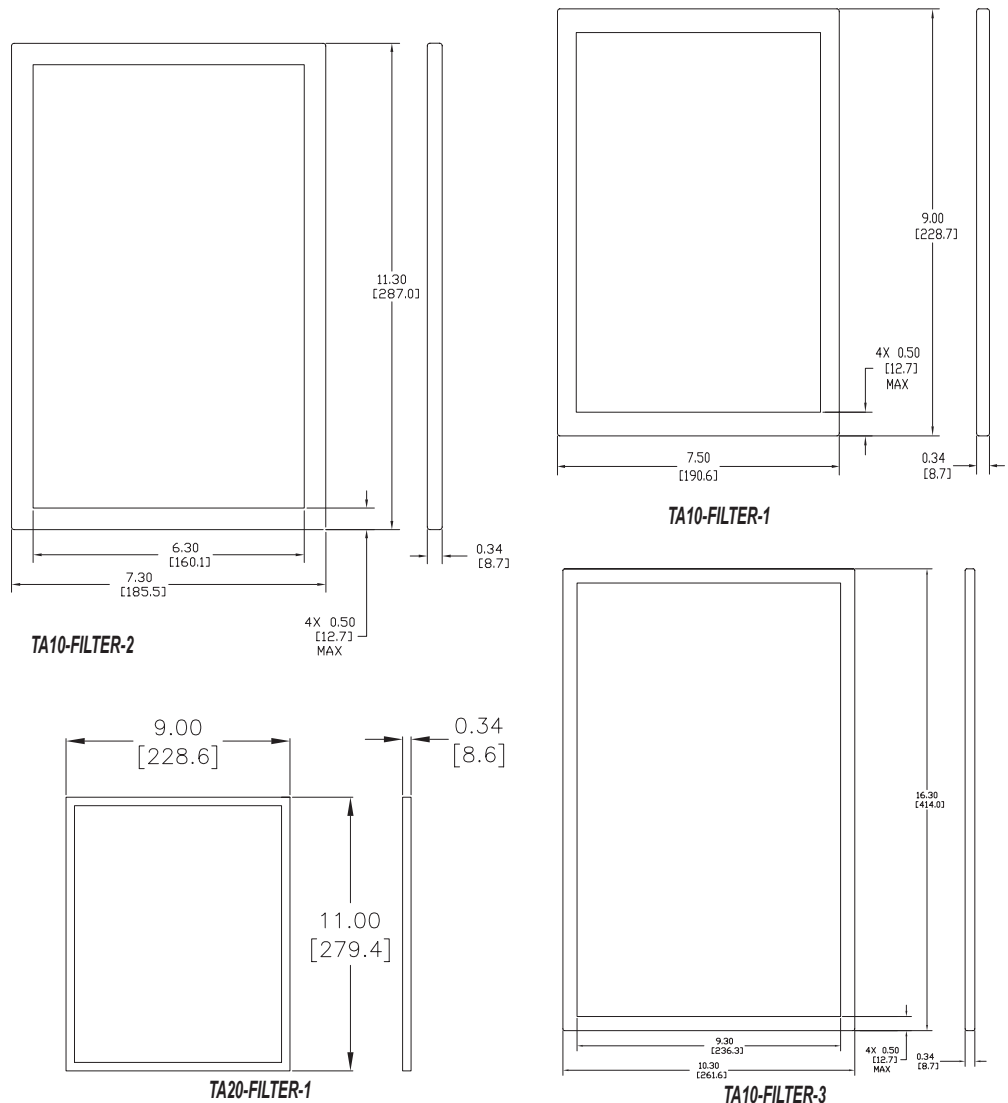

# 2.0in [51mm] Louvered Frame and Filter Kits



TA20-LVFL-1-4X

2.0in [51mm] louvered frame and filter kits are ideal in food processing or dirty environments where filter maintenance is crucial. Stratus offers extended surface, 2.0in [51mm] deep filter and sliding filter frame assemblies. In wash-down applications, stainless steel filters are preferred over aluminum filters.

## Features

- 2in louvered frame and filter kit
- 250 micron stainless steel mesh filter
- 97% efficiency extends filter capacity 400%
- Washable and reusable
- Deep filter frames easily retrofitted on existing units with standard filters using the same mounting hole and screws on your unit

Air Conditioner Filters			
Part Number	Price	Description	Frame Size
<a href="#"><u>TA10-LVFIL-2-04</u></a>		Stratus louvered filter frame assembly, carbon steel, ANSI 61 gray finish, with filter, washable, 2in filter depth, 250 micron stainless steel mesh, 97% filter efficiency. For use with 2000-4000 BTU/H TA10 series enclosure air conditioners on NEMA 4 or NEMA 12 enclosures.	TA10-2
<a href="#"><u>TA10-LVFIL-3-04</u></a>		Stratus louvered filter frame assembly, carbon steel, ANSI 61 gray finish, with filter, washable, 2in filter depth, 250 micron stainless steel mesh, 97% filter efficiency. For use with 5000-6000 BTU/H TA10 series enclosure air conditioners on NEMA 4 or NEMA 12 enclosures.	TA10-3
<a href="#"><u>TA10-LVFIL-2-4X</u></a>		Stratus louvered filter frame assembly, 304 stainless steel, with filter, washable, 2in filter depth, 250 micron stainless steel mesh, 97% filter efficiency. For use with 2000-4000 BTU/H TA10 series enclosure air conditioners on NEMA 4X enclosures.	TA10-2
<a href="#"><u>TA10-LVFIL-3-4X</u></a>		Stratus louvered filter frame assembly, 304 stainless steel, with filter, washable, 2in filter depth, 250 micron stainless steel mesh, 97% filter efficiency. For use with 5000-6000 BTU/H TA10 series enclosure air conditioners on NEMA 4X enclosures.	TA10-3
<a href="#"><u>TA20-LVFIL-1-04</u></a>		Stratus louvered filter frame assembly, carbon steel, ANSI 61 gray finish, with filter, washable, 2in filter depth, 250 micron stainless steel mesh, 97% filter efficiency. For use with 2000 BTU/H TA20 series enclosure air conditioners on NEMA 4 or NEMA 12 enclosures.	TA20-1
<a href="#"><u>TA20-LVFIL-1-4X</u></a>		Stratus louvered filter frame assembly, 304 stainless steel, with filter, washable, 2in filter depth, 250 micron stainless steel mesh, 97% filter efficiency. For use with 2000 BTU/H TA20 series enclosure air conditioners on NEMA 4X enclosures.	TA20-1

## Dimensions

