

# C-more Operator Panels Overview

## Getting started

Installing the software and configuring the **C-more** panel is simple. You will need the following to successfully connect, configure and send a project to the panel:

- **C-more** HMI - 6in, 7in wide, 8in, 10in, 10in wide, 12in, 15in or [EA9-RHMI](#)
- **C-more** Programming Software, p/n [EA9-PGMSW](#)
- **C-more** programming cable, USB or Ethernet
- 12-24 VDC switching power supply or the optional **C-more** AC Power Adapter, p/n [EA-AC](#)
- Personal Computer - to run **C-more** programming software
- PLC communications cable (serial or Ethernet) to connect the **C-more** HMI to your controller

Part Number	Description	Price
<a href="#">EA9-T6CL-R</a>	<b>C-more</b> EA9 series touch screen HMI, 6in color TFT LCD, analog resistive, 320 x 240 pixel, QVGA, LED backlight, (1) serial, (2) USB ports and (1) memory card slot.	
<a href="#">EA9-T6CL</a>	<b>C-more</b> EA9 series touch screen HMI, 6in color TFT LCD, analog resistive, 320 x 240 pixel, QVGA, LED backlight, (3) serial, (1) Ethernet, (2) USB ports, (1) memory card slot and (1) audio line out.	
<a href="#">EA9-T7CL-R</a>	<b>C-more</b> EA9 series touch screen HMI, 7in color TFT LCD, analog resistive, widescreen, 800 x 480 pixel, WVGA, LED backlight, (1) serial, (1) Ethernet, (2) USB ports and (1) memory card slot.	
<a href="#">EA9-T7CL</a>	<b>C-more</b> EA9 series touch screen HMI, 7in color TFT LCD, analog resistive, widescreen, 800 x 480 pixel, WVGA, LED backlight, (3) serial, (1) Ethernet, (2) USB ports, (1) memory card slot and (1) audio line out.	
<a href="#">EA9-T8CL</a>	<b>C-more</b> EA9 series touch screen HMI, 8in color TFT LCD, analog resistive, 800 x 600 pixel, SVGA, LED backlight, (3) serial, (1) Ethernet, (2) USB ports, (1) memory card slot and (1) audio line out.	
<a href="#">EA9-T10CL</a>	<b>C-more</b> EA9 series touch screen HMI, 10in color TFT LCD, analog resistive, 800 x 600 pixel, SVGA, LED backlight, (3) serial, (1) Ethernet, (2) USB ports, (1) memory card slot and (1) audio line out.	
<a href="#">EA9-T10WCL</a>	<b>C-more</b> EA9 series touch screen HMI, 10in color TFT LCD, analog resistive, widescreen, 1024 x 600 pixel, WSVGA, LED backlight, (3) serial, (1) Ethernet, (2) USB ports, (1) memory card slot and (1) audio line out.	
<a href="#">EA9-T12CL</a>	<b>C-more</b> EA9 series touch screen HMI, 12in color TFT LCD, analog resistive, 800 x 600 pixel, SVGA, LED backlight, (3) serial, (1) Ethernet, (2) USB ports, (2) memory card slots, (1) HDMI video out and (1) audio line out.	
<a href="#">EA9-T15CL-R</a>	<b>C-more</b> EA9 series touch screen HMI, 15in color TFT LCD, analog resistive, 1024 x 768 pixel, XGA, LED backlight, (1) serial, (1) Ethernet, (2) USB ports and (2) memory card slots.	
<a href="#">EA9-T15CL</a>	<b>C-more</b> EA9 series touch screen HMI, 15in color TFT LCD, analog resistive, 1024 x 768 pixel, XGA, LED backlight, (3) serial, (1) Ethernet, (2) USB ports, (2) memory card slots, (1) HDMI video out and (1) audio line out.	
<a href="#">EA9-RHMI</a>	<b>C-more</b> EA9 series headless HMI, (2) serial, (1) Ethernet and (2) USB ports, (1) HDMI audio/video out and (1) memory card slot.	
<a href="#">EA9-PGMSW</a>	<b>C-more</b> Windows programming software, USB or free download. For use with <b>C-more</b> EA9 series touch panels. Requires USB or Ethernet connection to touch panel.	on USB, or FREE download
<a href="#">USB-CBL-AB3</a>	AutomationDirect programming cable, USB A to USB B, 3ft cable length. For use with <b>C-more</b> HMIs, Do-more and Productivity series CPUs and most USB devices.	
<a href="#">USB-CBL-AB6</a>	AutomationDirect programming cable, USB A to USB B, 6ft cable length. For use with <b>C-more</b> HMIs, Do-more and Productivity series CPUs and most USB devices.	
<a href="#">USB-CBL-AB10</a>	AutomationDirect programming cable, USB A to USB B, 10ft cable length. For use with <b>C-more</b> HMIs, Do-more and Productivity series CPUs and most USB devices.	
<a href="#">USB-CBL-AB15</a>	AutomationDirect programming cable, USB A to USB B, 15ft cable length. For use with <b>C-more</b> HMIs, Do-more and Productivity series CPUs and most USB devices.	

# C-more Selection Guide & Specifications

Model	6" TFT color w/ base features	6" TFT color w/ full features	7" TFT color w/ base features	7" TFT color w/ full features
<b>Specification</b>				
<b>Part Number</b>	<a href="#">EA9-T6CL-R</a>	<a href="#">EA9-T6CL</a>	<a href="#">EA9-T7CL-R</a>	<a href="#">EA9-T7CL</a>
<b>Price</b>				
<b>Display Actual Size and Type</b>	5.7" TFT color		7.0" TFT color	
<b>Display Viewing Area</b>	4.54" x 3.40" [115.2 mm x 86.4 mm]		6.00" x 3.60" [152.4 mm x 91.4 mm]	
<b>Weight</b>	1.56 lb [710g]	1.59 lb [720g]	1.46 lb [660g]	1.48 lb [670g]
<b>Screen Pixel</b>	320 x 240 (QVGA)		800 x 480 (WVGA)	
<b>Display Brightness</b>	280 nits (typ)		350 nits (typ)	
<b>LCD Panel Dot Pitch</b>	0.18 mm x 0.18 mm		0.190 mm x 0.190 mm	
<b>Color Scale</b>	65,536 colors			
<b>Backlight Average Lifetime*</b>	50,000 hours @ 25°C			
<b>Touch Panel Type**</b>	Four-wire analog resistive, single touch			
<b>Project Memory</b>	26MB		43MB	
<b>Number of Screens</b>	Up to 999 screens – limited by project memory			
<b>Realtime Clock</b>	Realtime clock built into panel, backed up for 30 days at 25°C			
<b>Calendar – Month / Day / Year</b>	Yes - monthly deviation 60sec (Reference)			
<b>Serial Port 1</b>	15-pin D-sub female – RS232C, RS-422/485			
<b>Serial Port 2</b>	N/A	3-wire terminal block – RS-485	N/A	3-wire terminal block – RS-485
<b>Serial Port 3</b>	N/A	RJ-12 modular jack – RS-232C	N/A	RJ-12 modular jack – RS-232C
<b>USB Port – Type B</b>	USB 2.0 High speed (480 Mbps) Type B – Download/Program – Max. cable length 15-feet			
<b>USB Port – Type A</b>	USB 2.0 High speed (480 Mbps) Type A – for USB device options – Max. cable length 15-feet – Bus Power – Less than 200mA at 5VDC			
<b>Ethernet Port</b>	N/A	10/100 Base-T, auto MDI/MDI-X		
<b>Ethernet Port - Expansion Module</b>	N/A	<a href="#">EA-ECOM</a>	N/A	<a href="#">EA-ECOM</a>
<b>Audio Line Out</b>	N/A	3.5 mm mini jack – requires amplifier and speaker(s)	N/A	3.5 mm mini jack – requires amplifier and speaker(s)
<b>Mic In (Future)</b>	N/A	3.5 mm mini jack	N/A	3.5 mm mini jack
<b>SD Card Slot</b>	1 slot supports max 2GB (SD,) max 32GB (SDHC)			
<b>HDMI Video Out</b>	N/A			
<b>HDMI Supported Resolution</b>	N/A			
<b>Supply Power</b>	10.2-26.4 VDC Class 2 or SELV (Safety Extra-Low Voltage) Circuit or Limited Energy Circuit (LEC), or use the AC/DC Power Adapter, <a href="#">EA-AC</a> , to power the touch panel from a 100-240 VAC, 50/60 Hz power source. Reverse Polarity Protected			
<b>Power Consumption</b>	16.0 W 1.30 A @ 12VDC 0.66 A @ 24VDC			
<b>Internal Fuse (non-replaceable)</b>	4.0 A			
<b>Altitude</b>	Up to 2000m (6562ft)			
<b>Operating Temperature</b>	0 to 50°C (32 to 122°F) Maximum surrounding air temperature rating: 50°C (122°F) IEC 60068-2-14 (Test Nb, Thermal Shock)			
<b>Storage Temperature</b>	-20 to +60°C (-4 to +140°F) IEC 60068-2-1 (Test Ab, Cold) IEC 60068-2-2 (Test Bb, Dry Heat) IEC 60068-2-14 (Test Na, Thermal Shock)			
<b>Humidity</b>	5-95% RH (non-condensing)			
<b>Environment</b>	For use in Pollution Degree 2 environment, no corrosive gases permitted			
<b>Noise Immunity</b>	(EN61131-2), EN61000-4-2 (ESD), EN61000-4-3 (RFI), EN61000-4-4 (FTB), EN61000-4-5 (Serge), EN61000-4-6 (Conducted) EN61000-4-8 (Power frequency magnetic field immunity) (Local Test) RFI, (145MHz, 440Mhz 10W @ 10cm), Impulse 1000V @ 1µs pulse			
<b>Withstand Voltage</b>	1000VAC, 1min. (FG to Power supply )			
<b>Insulation Resistance</b>	> 10M ohm @ 500VDC (FG to Power supply )			
<b>Vibration</b>	IEC60068-2-6 (Test Fc)			
<b>Shock</b>	IEC60068-2-27 (Test Ea)			
<b>Emission</b>	EN55011 Class A (Radiated RF emission)			
<b>Enclosure</b>	NEMA 250 type 4/4X indoor use only UL50 type 4X indoor use only IP-65 indoor use only (When mounted correctly)		NEMA 250 type 4/4X indoor use only UL50 type 4X indoor use only IP-65 (not tested by UL) (When mounted correctly)	
<b>Agency Approvals</b>	UL508, E157382, Class 1, Div 2, Groups A, B, C CE (EN61131-2), RoHS (2011/65/EU) CUL Canadian C22.2		UL61010, E157382 CE (EN61131-2), RoHS (2011/65/EU) CUL Canadian C22.2	
<b>NOTES:</b>	*The backlight average lifetime is defined as the average usage time it takes before the brightness becomes 50% of the initial brightness. The lifetime of the backlight depends on the ambient temperature. The lifetime will decrease under low or high temperature usage. **The touchscreen is designed to respond to a single touch. If it is touched at multiple points at the same time, an unexpected object may be activated.			

# C-more 6" TFT Color Touch Panel - Base Model

## EA9-T6CL-R

**C-more** EA9 series touch screen interface panel, 6-inch color TFT (5.7 inch viewable screen), base model, 64K colors, 320 x 240 pixel QVGA screen resolution, 800MHz CPU, 12-24 VDC powered, NEMA 4/4X, IP65 (when mounted correctly; for indoor use only), non-replaceable LED backlight. Includes (1) serial port, USB 2.0 Type A and B ports, supports SD memory card, no Ethernet support. Compatible with [EA9-PGMSW](#) programming software version 5.0 or later.

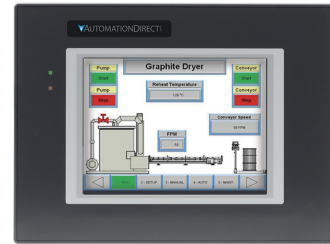

## Features

- 5.7" diagonal color TFT (Thin Film Transistor) LCD display with 64K colors
- 320 x 240 pixel resolution
- 280 NITS display brightness
- 50,000 hour average backlight half-life
- Analog resistive (1024 X 1024) touch screen allowing unlimited touch areas
- USB port B (program/download) and USB port A (USB device options)
- Serial PLC interface (RS-232/422/485)
- One built-in SD memory card slot
- 12-24 VDC powered, 110 VAC power adapter (optional)
- 26MB project memory
- 0 to 50°C (32 to 122°F) operating temperature range
- NEMA 4/4X, IP65 compliant when mounted correctly, indoor use only
- Slim design saves panel space
- UL Class 1, Div 2, Groups A, B, C cUL & CE agency approvals
- 2-year warranty from date of purchase

Function	Available
Ethernet	No
USB	Yes
SD Card	Yes
Audio Out	No
HDMI Video Out	No
Expansion Module	No



**NOTE: EA9-T6CL-R does not support Ethernet.**

## Dimensions

Units: inches [mm]

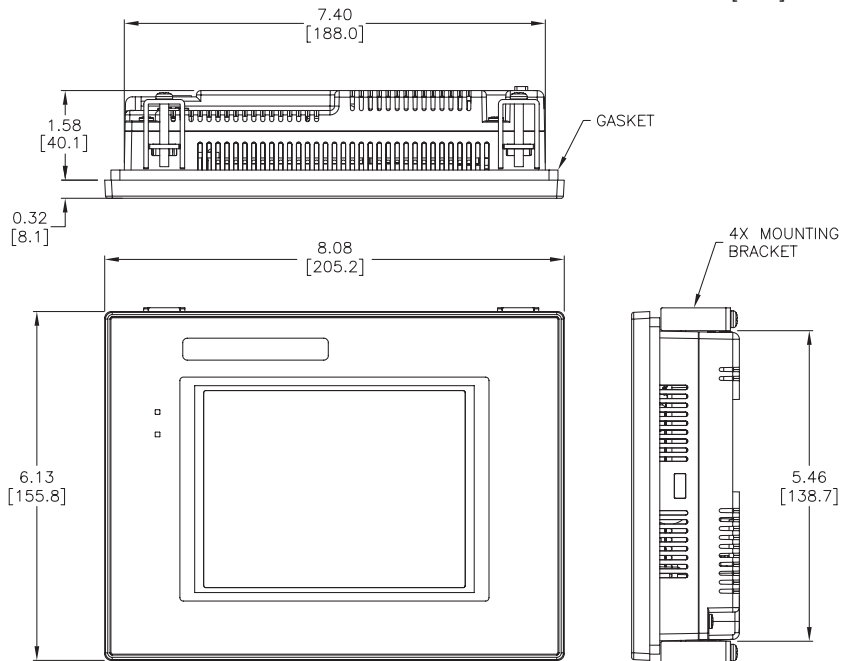

See our website [www.AutomationDirect.com](http://www.AutomationDirect.com) for complete engineering drawings.

## Mounting Cutout

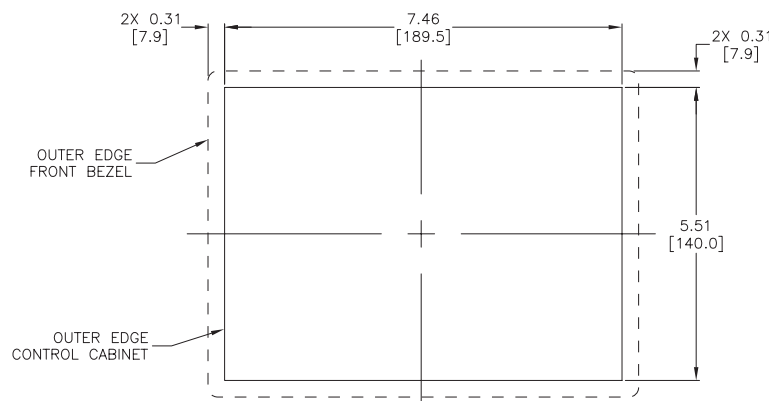

# C-more Communication Ports

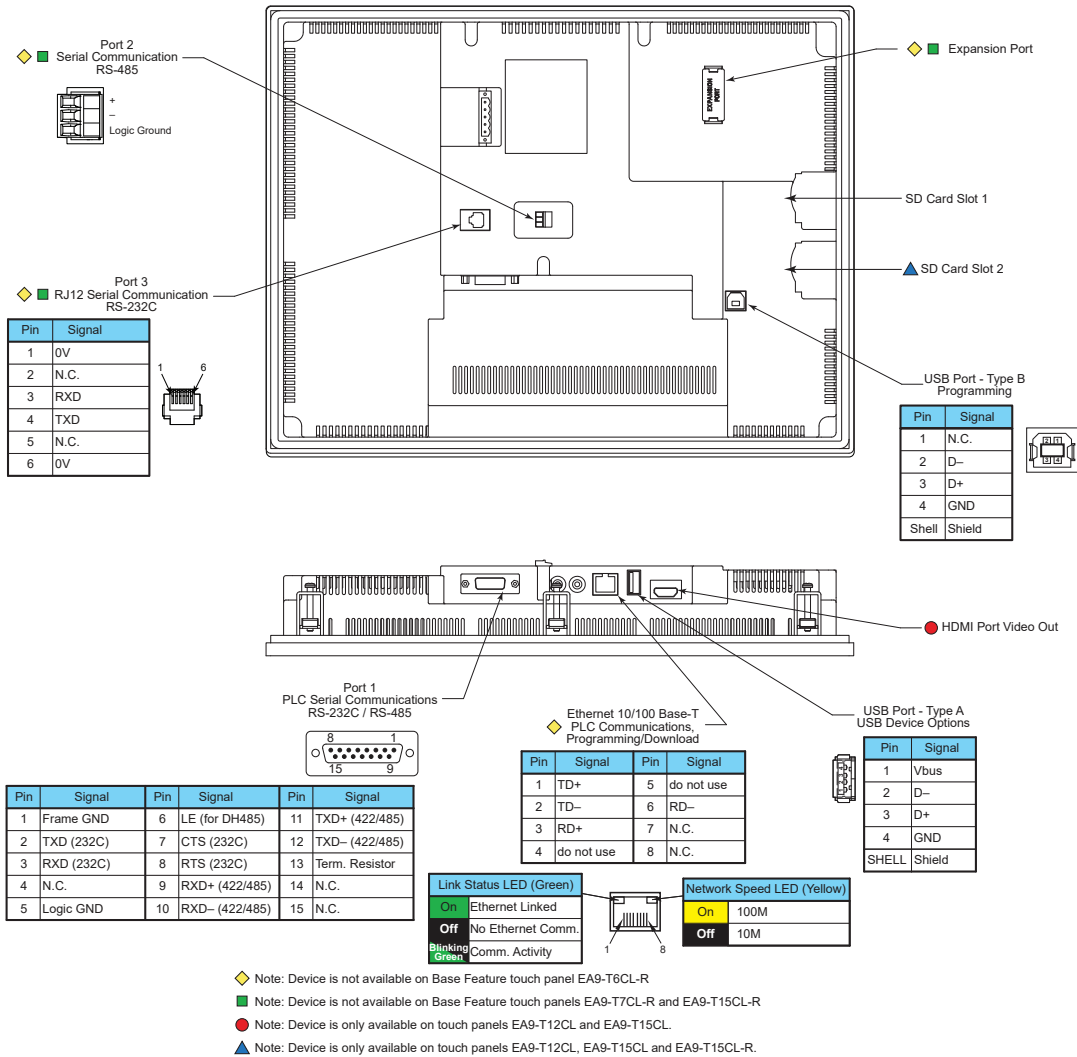

## Ethernet Port

The Ethernet port has several uses:

- Download program to panel
- Communicate to PLCs/PCs
- Send e-mail
- Access FTP server
- Act as a Webserver (Secure HTTPs)
- Remote Internet access

The Ethernet port has an RJ-45 8-wire modular connector with green and yellow LEDs.

- The yellow LED indicates network speed – off for a 10 Mbps connection and illuminated for a 100 Mbps connection.
- The green LED indicates link status and illuminates when a link is established.

Note: EA6-T6CL-R does not include an Ethernet port, and does not have these capabilities.

## Expansion Port

The expansion port supports the EA-ECOM module to provide a second Ethernet Port for all full featured models.

## USB Port B

Program **C-more** via the USB programming port. It's fast and easy, with no baud rate settings, parity, or stop bits to worry about. We stock standard USB cables for your convenience. USB Port B can be used to upload or download projects to and from a PC.

## USB Port A

The Universal Serial Bus (USB) Port A is a standard feature on all models and can be used to connect various USB HID (Human Input Device) devices to the panel, such as the following:

- USB flash drives ([USB-FLASH](#))
- USB keyboards
- USB barcode scanners
- USB card scanners

**C-more** can log data to the USB flash drive as well as load projects to the panel from the pen drive. You can also back up project files and panel firmware.

## Sound Interface (Audio Line Out)

When attached to an amplifier and speaker(s), **C-more** can play warning sounds or pre-recorded messages such as: "conveyor is jammed". **C-more** supports WAV type files. The output is stereo.

## Serial Port

**Port 1** - Connect to your serial controller network via Port 1. Port 1 is a 15-pin port that supports RS-232 or RS-422/485.

**Port 2** - Connect your RS-485 network via Port 2. Port 2 is provided with a 3-wire removable terminal block.

**Port 3** - Connect to your RS-232C device via Port 3. Port 3 is an RJ12 connection.

## HDMI Video Out

EA9-T12CL and EA9-T15CL include an HDMI Type A port to provide video output to a projector or remote monitor.

# C-more Communication Protocols & Cables

Compatibility Table			
PLC Family	Model	Protocols	
Allen-Bradley	MicroLogix 1000, 1100, 1200, 1400, 1500, SLC 5-01/02/03	DH485/AIC/AIC+	
	MicroLogix 1000, 1100, 1200, 1400 and 1500 SLC 5-03/04/05	DF1 Half Duplex; DF1 Full Duplex	
	ControlLogix™, CompactLogix™, FlexLogix™ PLC-5	DF1 Full Duplex	
	ControlLogix, CompactLogix, FlexLogix - Tag Based	DF1 Half Duplex; DF1 Full Duplex	
	ControlLogix, CompactLogix, FlexLogix - Generic I/O Messaging	EtherNet/IP Server	
	ControlLogix, CompactLogix, FlexLogix - Tag Based	EtherNet/IP Client	
	Micrologix 1100, 1400 & SLC5/05, all via native Ethernet port		
	MicroLogix 1000, 1100, 1200, 1400,1500 & SLC 5-03/04/05, all via ENI Adapter		
	Micro 800 series	Modbus RTU Modbus TCP	
	Micro 800 series - Tag Based	DF1 Full Duplex EtherNet/IP Client	
<b>Modbus RTU</b>	Modbus RTU devices	Modbus RTU	
<b>Modbus TCP/IP</b>	Modbus TCP/IP devices	Modbus TCP/IP	
<b>GE</b>	90/30, 90/70, Micro 90, VersaMax Micro	SNPX	
	90/30, Rx3i	SRTP Ethernet	
<b>Mitsubishi</b>	FX Series	FX Direct	
	Q02, Q02H, Q06H, Q12H, Q25H	Q CPU	
	Q, QnA Serial Q, QnA Ethernet	QnA Serial QnA Ethernet	
<b>Omron</b>	C200 Adapter, C500	Host Link	
	CJ1/CS1 Serial, CJ1/CS1 Ethernet	FINs	
<b>Modicon</b>	984 CPU, Quantum 113 CPU, AEG Modicon Micro Series 110 CPU: 311-xx, 411-xx, 512-xx, 612-xx	Modbus RTU	
<b>Siemens</b>	S7-200 CPU, RS-485 Serial	PPI	
	S7-200 CPU, S7-300 CPU, S7-400, S7-1200 CPU, S7-1500; Ethernet	Ethernet ISO over TCP	
<b>Productivity Series</b>	all	Productivity Serial Productivity Ethernet	
	all	Do-more Serial Do-more Ethernet	
<b>CLICK</b>	all	Modbus (CLICK addressing) Modbus TCP (CLICK addressing)	
	Direct LOGIC	DL05/DL06	all
H0-ECOM/H0-ECOM100			Direct LOGIC Ethernet
DL105			all
DL205		D2-230	K-Sequence
		D2-240	K-Sequence DirectNET
		D2-250/D2-250-1/D2-260/ D2-262	K-Sequence
			DirectNET Modbus (Koyo addressing)
		D2-240/D2-250-1/D2-260 using D2-DCM	DirectNET Modbus (Koyo addressing)
		H2-ECOM/H2-ECOM100	Direct LOGIC Ethernet
DL305		D3-330/330P (Requires the use of a Data Communications Unit)	DirectNET
		D3-340	DirectNET
		D3-350	K-Sequence DirectNET Modbus (Koyo addressing)
			DirectNET
DL405		D3-350 using D3-DCM	Modbus (Koyo addressing)
		D4-430	K-Sequence DirectNET
		D4-440	K-Sequence DirectNET
		D4-450/D4-454	K-Sequence DirectNET Modbus (Koyo addressing)
			DirectNET
		All with D4-DCM	Modbus (Koyo addressing)
		H4-ECOM/H4-ECOM100	Direct LOGIC Ethernet
H2-WinPLC (Think & Do) Live V5.2 or later and Studio any version	Think & Do Modbus RTU (serial port)		
H2-WinPLC (Think & Do) Live V5.5.1 or later and Studio V7.2.1 or later	Think & Do Modbus TCP/IP (Ethernet port)		

Cable Description	Cable Part Number	Price
AutomationDirect communication cable, 15-pin male D-sub to 6-pin RJ12, shielded, 9.8ft/3m cable length. For use with <b>C-more</b> or <b>C-more</b> Micro panel and AutomationDirect PLCs with RJ12 ports.	<a href="#"><u>EA-2CBL</u></a>	
AutomationDirect communication cable, 15-pin male D-sub to 15-pin D-sub HD15 male, shielded, 3m/9.8ft cable length. For use with <b>C-more</b> or <b>C-more</b> Micro panel and a DL06, D2-250(-1), D2-260 or D2-262 (bottom port) CPU.	<a href="#"><u>EA-2CBL-1</u></a>	
AutomationDirect communication cable, 15-pin male D-sub to 4-pin RJ11, shielded, 3m/9.8ft cable length. For use with <b>C-more</b> or <b>C-more</b> Micro panel and a D3-340 CPU top or bottom port.	<a href="#"><u>EA-3CBL</u></a>	
AutomationDirect communication cable, 15-pin male D-sub to 15-pin male D-sub, shielded, 3m/9.8ft cable length. For use with <b>C-more</b> or <b>C-more</b> Micro panel and a DL405 (top port) CPU.	<a href="#"><u>EA-4CBL-1</u></a>	
AutomationDirect communication cable, 15-pin male D-sub to 25-pin male D-sub, shielded, 3m/9.8ft cable length. For use with <b>C-more</b> or <b>C-more</b> Micro panel and a D2-DCM, D3-232-DCU, D3-350 (bottom port) or DL405 (bottom port) CPU.	<a href="#"><u>EA-4CBL-2</u></a>	
AutomationDirect communication cable, 15-pin male D-sub to 8-pin male mini DIN, shielded, 3m/9.8ft cable length. For use with <b>C-more</b> or <b>C-more</b> Micro panel and an Allen-Bradley Micrologix CPU.	<a href="#"><u>EA-MLOGIX-CBL</u></a>	
AutomationDirect communication cable, 15-pin male D-sub to 9-pin female D-sub, shielded, 3m/9.8ft cable length. For use with <b>C-more</b> or <b>C-more</b> Micro panel and an Allen-Bradley SLC 5/03, 5/04 or 5/05 CPU with DF-1 port.	<a href="#"><u>EA-SLC-232-CBL</u></a>	
AutomationDirect communication cable, 15-pin male D-sub to 25-pin male D-sub, shielded, 3m/9.8ft cable length. For use with <b>C-more</b> or <b>C-more</b> Micro panel and an Allen-Bradley PLC-5 CPU with a DF1 port.	<a href="#"><u>EA-PLC5-232-CBL</u></a>	
AutomationDirect communication cable, 15-pin male D-sub to 6-pin RJ45, shielded, 3m/9.8ft cable length. For use with <b>C-more</b> or <b>C-more</b> Micro panel and an Allen-Bradley SLC 5/01, 5/02 or 5/03 CPU with a DH485 port cable.	<a href="#"><u>EA-DH485-CBL</u></a>	
AutomationDirect communication cable, 15-pin male D-sub to 15-pin male D-sub, shielded, 3m/9.8ft cable length. For use with <b>C-more</b> or <b>C-more</b> Micro and GE Fanuc Series 90/30 or 90/70 serial port.	<a href="#"><u>EA-90-30-CBL</u></a>	
AutomationDirect communication cable, 15-pin male D-sub to 25-pin male D-sub, 3m/9.8ft cable length. For use with <b>C-more</b> or <b>C-more</b> Micro panel and a Mitsubishi FX Series CPU.	<a href="#"><u>EA-MITSU-CBL</u></a>	
AutomationDirect communication cable, 15-pin male D-sub to 8-pin male mini DIN, shielded, 3m/9.8ft cable length. For use with <b>C-more</b> or <b>C-more</b> Micro panel and a Mitsubishi FX Series CPU.	<a href="#"><u>EA-MITSU-CBL-1</u></a>	
AutomationDirect communication cable, 15-pin male D-sub to 25-pin male D-sub, shielded, 3m/9.8ft cable length. For use with <b>C-more</b> or <b>C-more</b> Micro panel and an Omron C200 or C500 CPU.	<a href="#"><u>EA-OMRON-CBL</u></a>	

## Example Cables:



# C-more Computer Programming Connections

Using the **C-more** Programming Software [EA9-PGMSW](#) for project development, the HMI can be connected to a PC (personal computer) in one of several ways:

- Connect a USB Programming Cable such as (USB-CBL-AB15) from a USB port type A on the PC to the USB type B programming port on the **C-more** HMI. The USB connection is for direct connection only and does not support USB hubs.
- Connect the **C-more** HMI to a PC with a Cat5 Ethernet cable via an Ethernet switch. Multiple **C-more** HMIs can be programmed in this configuration.

Following are the minimum system requirements for running **C-more** Programming Software, p/n [EA9-PGMSW](#), on a PC:

- USB or Ethernet connection to HMI (cables sold separately).
- Windows operating system - see [automationdirect.com](http://automationdirect.com) for specific operating system requirements.



**NOTE: Regarding Ethernet access to a C-more HMI.**  
 If you intend to take advantage of the methods of remote access to the HMI, including the Webserver (Secure HTTPs), PC remote access, FTP, iPhone or iPad app, you need to consider the security exposure in order to minimize the risks to your process and your C-more HMI.

Security measures may include password protection, changing the ports exposed on your network, including a VPN in your network, and other methods. Security should always be carefully evaluated for each installation.

## USB Programming Cable



### Part No. USB-CBL-ABxx

USB Programming Cables		
Part Number	Length	Price
USB-CBL-AB3	3 feet	
USB-CBL-AB6	6 feet	
USB-CBL-AB10	10 feet	
USB-CBL-AB15	15 feet	

## Stride® Ethernet Switch



### USB Connectivity

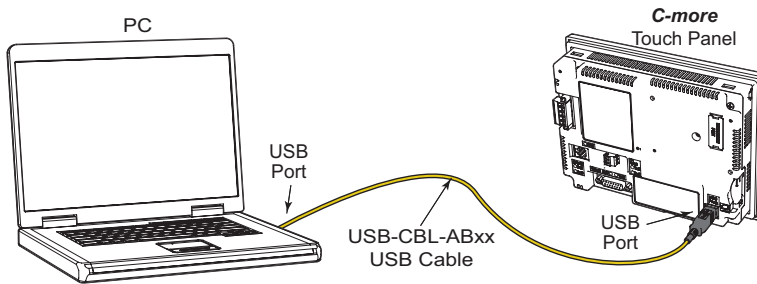

### Ethernet Connectivity via a Hub or Switch

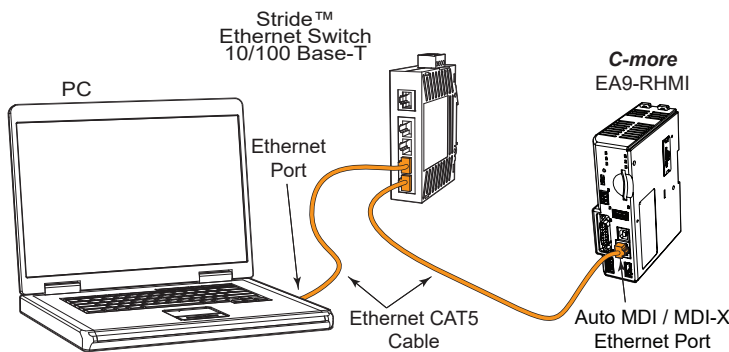

### Ethernet Direct Connection

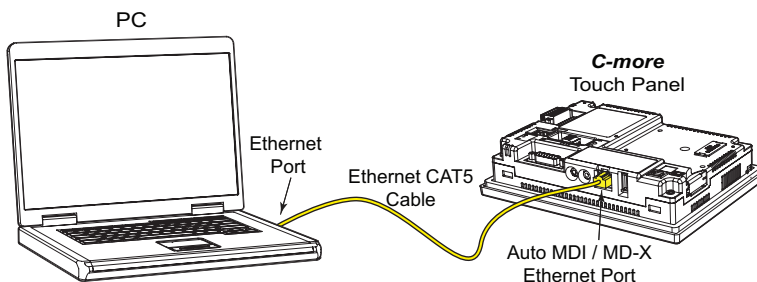

# C-more Accessories

## Accessories

C-more touch panels can be enhanced with the accessories below:

Part Number	Description	Price
<a href="#"><u>EA-AC</u></a>	C-more AC/DC power adapter, 24 VDC, 1.5A. For use with C-more EA7 and EA9 series touch panels.	
<a href="#"><u>EA-6-COV2</u></a>	C-more screen protector, non-glare, 6in. Package of 3. For use with C-more and C-more Micro 6in HMIs.	
<a href="#"><u>EA-7-COV2</u></a>	C-more screen protector, non-glare, 7in. Package of 3. For use with C-more 7in HMIs.	
<a href="#"><u>EA-8-COV2</u></a>	C-more screen protector, non-glare, 8in. Package of 3. For use with C-more and C-more Micro 8in HMIs.	
<a href="#"><u>EA-10-COV2</u></a>	C-more Micro screen protector, non-glare, 10in. Package of 3. For use with C-more EA9-T10CL and C-more Micro EA3-T10CL HMIs.	
<a href="#"><u>EA-10W-COV2</u></a>	C-more screen protector, non-glare, 10in. Package of 3. For use with C-more EA9-T10WCL widescreen HMI.	
<a href="#"><u>EA-12-COV2</u></a>	C-more screen protector, non-glare, 12in. Package of 3. For use with C-more 12in HMIs.	
<a href="#"><u>EA-15-COV2</u></a>	C-more screen protector, non-glare, 15in. Package of 3. For use with C-more 15in HMIs.	
<a href="#"><u>EA-ECOM</u></a>	C-more communication expansion module, (1) RJ45 10/100 Mbps Ethernet port. For use with C-more Micro EA3 series 6in, 8in and 10in panels and all C-more HMIs except CM5 series and -R models.	
<a href="#"><u>EA-COMCON-3</u></a>	C-more DSUB port adapter, 15-pin male to 6-pole RS-422/485 terminal block, right angle cable entry. For use with C-more Micro EA1 series 4in and 6in HMIs, C-more Micro EA3 series 3in, 4in, and 6in HMIs, C-more EA9 6in and 7in HMIs and C-more CM5 series 4in HMI.	
<a href="#"><u>EA-COMCON-3A</u></a>	C-more Micro DSUB port adapter, 15-pin male to 6-pole RS-422/485 terminal block, straight cable entry. For use with C-more Micro EA1 3in with EA1-MG-SP1, EA3 8in and 10in HMIs, C-more EA9 8in, 10in, 12in and 15in and CM5 7in, 10in, 12in, 15in and 22in HMIs.	
<a href="#"><u>EA-SD-CARD</u></a>	C-more industrial memory card, 2 GB SD. For use with all products with SD memory card slot.	
<a href="#"><u>USB-FLASH</u></a>	SanDisk USB Flash drive, 32 GB.	

## Accessory Locations

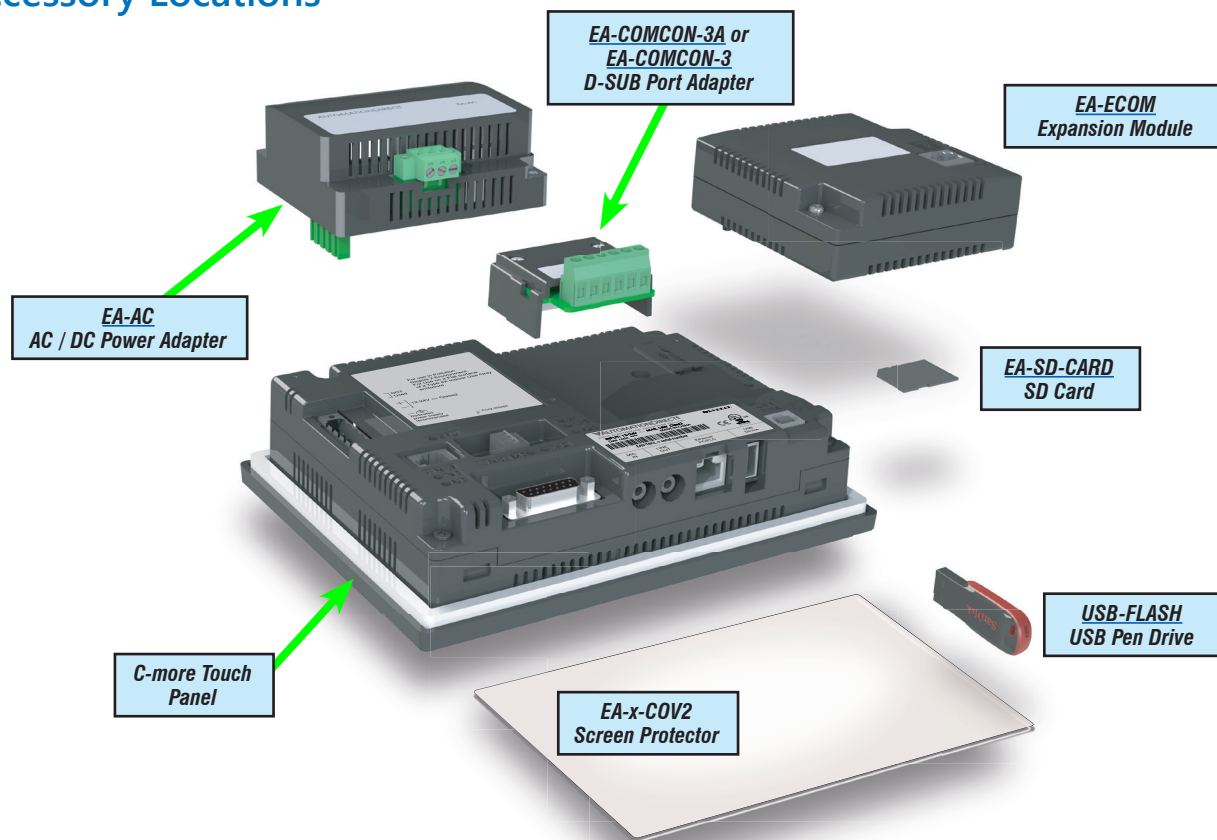

# C-more Accessories

## AC/DC Power Adapter

The optional **C-more** AC/DC Power Adapter can be used to power the **C-more** touch panels from a 100-240 VAC, 50/60 Hertz, voltage source. The adapter provides 24VDC @ 1.5 A to the touch panel's DC power connector and can be conveniently secured to the touch panel with two captive screws. The adapter provides a power loss signal to the

touch panel that causes the touch panel to stop writing data to SD memory devices providing a controlled shutdown for increased data logging reliability. EA-AC is not compatible with EA9-RHMI.

### Part No. EA-AC



### Overall Panel Depth w/ EA-AC Installed

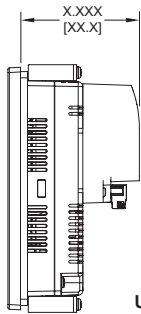

- EA9-T6CL-R = 2.99 [75.9]
- EA9-T6CL = 2.99 [75.9]
- EA9-T7CL-R = 2.99 [75.9]
- EA9-T7CL = 2.99 [75.9]
- EA9-T8CL = 3.51 [89.2]
- EA9-T10CL = 3.51 [89.2]
- EA9-T10WCL = 3.51 [89.2]
- EA9-T12CL = 3.35 [85.1]
- EA9-T16CL-R = 3.35 [85.1]
- EA9-T15CL = 3.35 [85.1]

Units: inches[mm]

## Dimensions

Units: inches [mm]

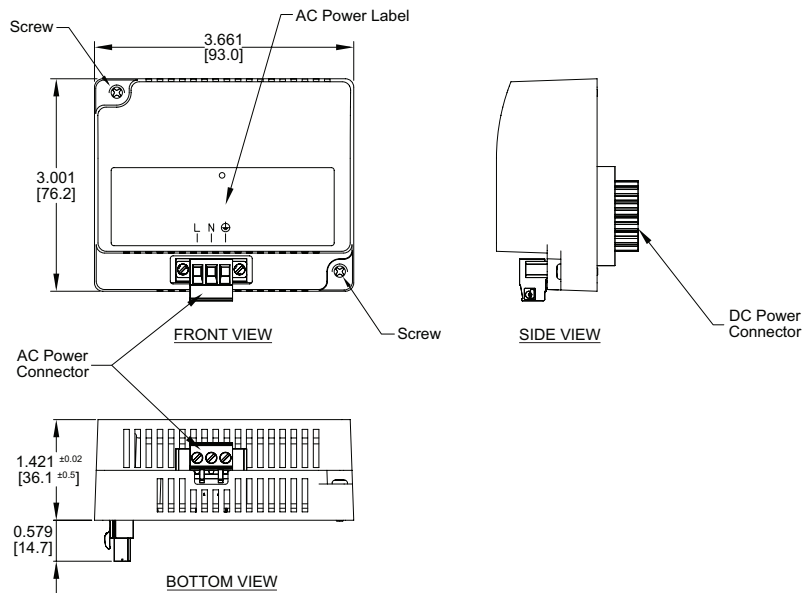

AC/DC Power Adapter Specifications			
<b>Part Number</b>	EA-AC	<b>Short Circuit Protection</b>	85VAC: 2.6 A, 100VAC: 2.8 A, 264VAC: 3.9 A
<b>Input Voltage &amp; Frequency</b>	100-240 VAC +10% -15%; 50/60 Hertz	<b>Static Electricity Discharge Resistance</b>	Compliant with IEC61000-4-2, Contact: 4 kV, Air: 8 kV
<b>Wire</b>	24-14 AWG, 60 / 75°C Copper. Tighten to 72 oz-in (0.5 Nm)	<b>Agency Approvals</b>	UL508 - UL Recognized for use with <b>C-more</b> panels, cUL, CE, EMC EN61132-2
<b>Permissible Momentary Power Failure</b>	Within 40ms	<b>Environment</b>	For use in pollution degree 2 environment
<b>Input Power</b>	68VA or less	<b>Grounding</b>	Ground resistance: less than 100 ohm
<b>Operating Temperature Range</b>	0°C to 50°C [32 to 122°F] Maximum surrounding temperature rating, 50°C	<b>Dimensions - inches [mm]</b>	3.00" (H) x 3.66" (W) x 1.42" (D) [76.2 mm x 93.0 mm x 36.1 mm] (Excluding DC Power Connector.)
<b>Storage Temperature Range</b>	-20 to 60°C [-4 to 140°F]	<b>Weight</b>	6.13 oz. [175 g]
<b>Operating &amp; Storage Humidity</b>	10-85% RH (non-condensing)	<b>Cooling Method</b>	Natural convection
<b>Noise Immunity</b>	1000VAC p-p (Pulse width 1 μs, rise time: 1 ns), with proper ground connection on AC terminal block.	<b>Removable AC Power Connector (included)</b>	EA-AC-CON or DECA Switchlab MC101-508-03G Secured with (2) captive M2.5 screws, torque to 70 oz-in [0.5 Nm]
<b>Hi-Pot</b>	1000VAC, 1 minute, with proper ground connection on AC terminal block.	<b>Output Voltage and Ripple</b>	21.6 - 26.4 VDC, Ripple < 100 mV p-p
<b>Insulation Resistance</b>	500VDC, 10 M ohm or above, with proper ground connection on AC terminal block.	<b>Output Current</b>	Maximum 1.5 A
<b>Vibration</b>	Compliant with IEC61131-2	<b>Inrush Current</b>	For 100VAC: 15A, 3ms or less For 240VAC: 20A, 3ms or less
<b>Shock</b>	Pulse shape: Sine half wave, Peak acceleration: 147 m/s <sup>2</sup> (15 G), X, Y, Z: 3 directions, 2 times each	<b>Mounting to Touch Panel</b>	Secure with (2) spring loaded captive M3-20 screws, torque to 50 oz-in [0.35 Nm]
<b>Thermal Protection</b>	140°C [284°F], with autorecovery	<b>Recommended External Fuse</b>	3.0A (ADC p/n: MDL3)

# C-more Accessories

## SD Card

### EA-SD-CARD



SD memory card for non-volatile storage, 2GB industrial grade, 70° C maximum operating temperature makes it suitable for data logging in industrial applications. Recommended for **C-more** EA9 series. The EA-SD-CARD utilizes SLC technology so it is the fastest option for writing and storing data. If logged data is saved to external memory, AutomationDirect recommends using an EA-SD-CARD. EA-SD-CARD may be used with all products with an SD card slot.

SLC Flash memory utilized by EA-SD-CARD has the advantage of being the most accurate flash memory type when reading and writing data. SLC Flash has the longest lifespan of flash types and can operate in a broader temperature range than other types.

EA-SD-CARD with SLC Flash memory is recommended for industrial workloads that require heavy read / write cycles.

EA-SD-CARD Specifications	
<b>Operating Temperature</b>	0 to 70°C (32 to 158°F)
<b>Humidity</b>	20 to 85% (non-condensing)
<b>Capacity</b>	2GB
<b>Speed Modes</b>	High-Speed Normal-Speed
<b>Interface</b>	SD Memory Card Specification Ver. 3.0
<b>Speed Class</b>	Class 6
<b>NAND Type</b>	SLC

## USB Flash Drive

### USB-FLASH



USB flash drive for non-volatile storage, 32GB. Recommended for the **C-more** EA9 series touch panels.

# C-more Accessories

## D-SUB 15-pin to Terminal Block Adapter - Right Angle

The **EA-COMCON-3** adapter plugs into the 15-pin serial port on the rear of a panel to allow wire terminal connections for an RS-422/RS-485 communication cable. Compatible with all **C-more** EA7 series panels, EA9-T6CL(-R) and EA9-T7CL(-R) panels, CM5-T4W and **C-more** Micro 4" and 6" panels. EA-COMCON-3 is UL Recognized

**Part No.**  
**EA-COMCON-3**

**Dimensions**

Units: inches [mm]

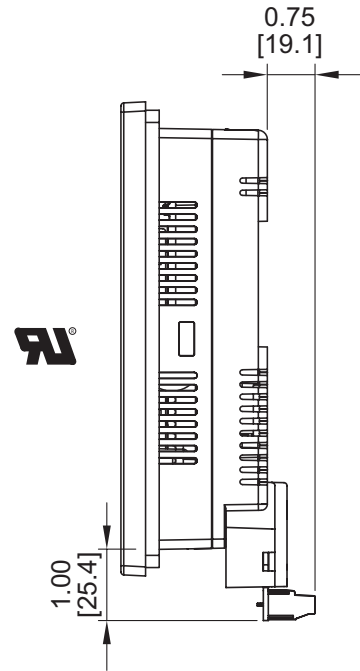
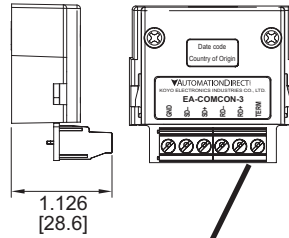
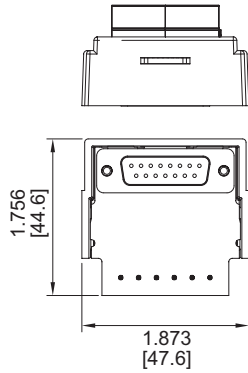

**Terminals**

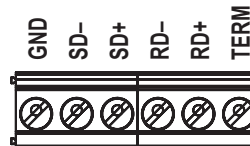

## D-SUB 15-pin to Terminal Block Adapter - Straight Through

The **EA-COMCON-3A** adapter plugs into the 15-pin serial port on the rear of a panel to allow wire terminal connections for an RS-422/RS-485 communication cable. Compatible with **C-more** EA9 series panels, EA9-RHMI, CM5-T7W, CM5-T10W, CM5-T12W, CM5-T15W, CM5-T22W, **C-more** Micro EA3-T8CL and EA3-T10CL panels and EA1-S3x with EA1-MG-SP1. Not compatible with EA9-T6CL(-R) and EA9-T7CL(-R) panels. The **EA-COMCON-3A** is not UL recognized or listed.

**Part No.**  
**EA-COMCON-3A**

**Dimensions**

Units: inches [mm]

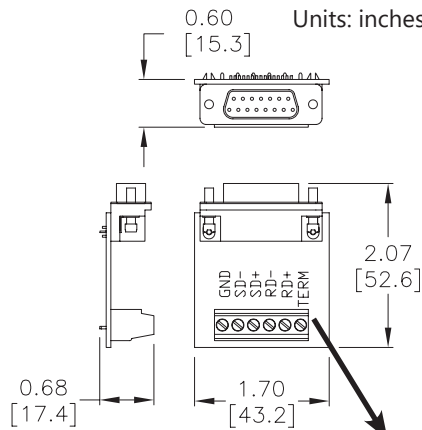

**Terminals**

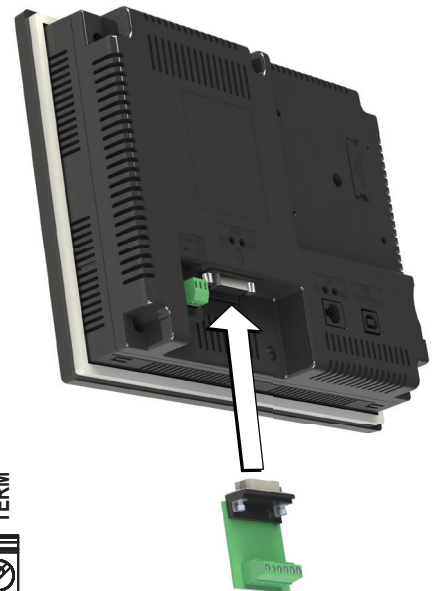
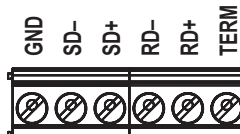

EA-COMCON-3(A) Wiring Specs	
Wire Size	Screw Torque
14-24 AWG	4.4 lb-in [0.5 Nm]

# C-more Accessories

## Non-glare Screen Covers (in packages of 3)

The non-glare screen covers are protective overlays used to protect the touch screen while helping to reduce the glare from external light sources.

**Part Numbers:** EA-6-COV2, EA-7-COV2, EA-8-COV2, EA-10-COV2, EA-10W-COV2, EA-12-COV2 and EA-15-COV2

### Dimensions

Units: inches [mm]

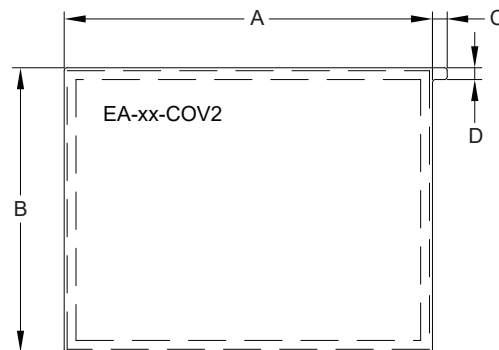
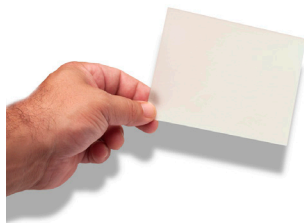

[EA-6-COV2](#)

[EA-7-COV2](#)

[EA-8-COV2](#)

[EA-10-COV2](#)

[EA-10W-COV2](#)

[EA-12-COV2](#)

[EA-15-COV2](#)

Non-glare Screen Covers Dimensions - inches [mm]				
Part Number	A	B	C	D
<a href="#">EA-6-COV2</a>	4.91 [124.8]	3.80 [96.4]	0.197 [5.0]	0.157 [4.0]
<a href="#">EA-7-COV2</a>	6.40 [162.6]	4.00 [101.5]		
<a href="#">EA-8-COV2</a>	7.32 [185.8]	5.44 [138.2]		
<a href="#">EA-10-COV2</a>	8.91 [226.2]	6.61 [168.0]		
<a href="#">EA-10W-COV2</a>	9.23 [234.5]	5.38 [136.7]		
<a href="#">EA-12-COV2</a>	10.10 [256.5]	7.64 [194.1]		
<a href="#">EA-15-COV2</a>	12.56 [319.1]	9.37 [238.1]		

## Installation

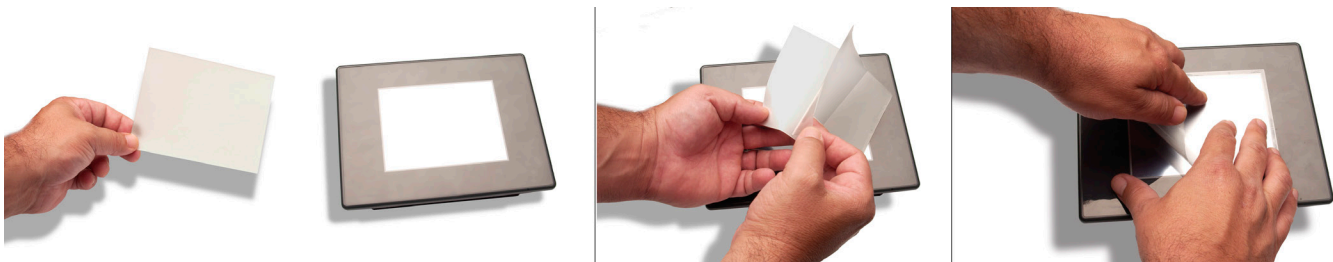





**NOTE:** The Protective Cover ships with a thin protective sheet on the face of the cover that needs to be carefully removed. If your panel is not clear, the protective sheet may not have been removed.

# C-more Replacement Parts

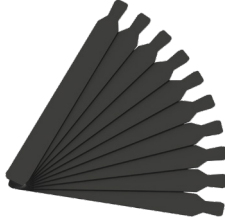
These replacement parts can be used to replace damaged, worn or lost **C-more** components.

## Replacement parts at a glance:

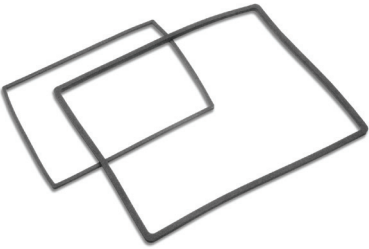
Part Number	Price		Description
<a href="#"><u>EA9-BRK</u></a>			<b>C-more</b> panel mounting brackets, replacement. Package of 8. For use with <b>C-more</b> EA9 series touch panels.
<a href="#"><u>EA9-LBL</u></a>			<b>C-more</b> blank label insert, replacement. Package of 10. For use with <b>C-more</b> EA9 series HMI front bezel.
<a href="#"><u>EA9-3TB</u></a>			<b>C-more</b> pluggable terminal block, replacement, 3-pole. Package of 2. For use with 3-wire RS485 communications port on <b>C-more</b> EA9 series panels.
<a href="#"><u>C0-4TB</u></a>			CLICK terminal blocks, replacement, 4-pole. Package of 2. For use with CLICK PLCs, <b>C-more</b> CM5 series HMIs and <b>C-more</b> EA9-RHMI.
<a href="#"><u>EA-DC-CON</u></a>			<b>C-more</b> DC 5-terminal power connector, replacement. For use with <b>C-more</b> EA7 and EA9 series touch panels.
<a href="#"><u>EA-AC-CON</u></a>			<b>C-more</b> AC 3-terminal power connector, replacement. For use with <b>C-more</b> AC adapter (p/n EA-AC).
<a href="#"><u>EA9-15-GSK</u></a>			<b>C-more</b> panel mounting gasket, replacement. For use with <b>C-more</b> EA9 series 15in HMIs.
<a href="#"><u>EA9-12-GSK</u></a>			<b>C-more</b> panel mounting gasket, replacement. For use with <b>C-more</b> EA9-T12CL 12in touch panel.
<a href="#"><u>EA9-10W-GSK</u></a>			<b>C-more</b> panel mounting gasket, replacement. For use with <b>C-more</b> EA9-T10WCL 10in HMI.
<a href="#"><u>EA9-10-GSK</u></a>			<b>C-more</b> panel mounting gasket, replacement. For use with <b>C-more</b> EA9-T10CL 10in HMI.
<a href="#"><u>EA9-8-GSK</u></a>			<b>C-more</b> panel mounting gasket, replacement. For use with <b>C-more</b> EA9-T8CL 8in touch panel.
<a href="#"><u>EA9-6-GSK</u></a>			<b>C-more</b> panel mounting gasket, replacement. For use with <b>C-more</b> EA9 series 6in and 7in touch panels.