



# Pneumatic Manual Valves

## 303 Stainless Steel Single Stem Style



Part No. GVS-3C0F-TD-SS



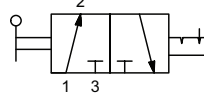
Part No. GVS-3C0F-PB-SS

NITRA GVS manual valves offer a simple, convenient method for directional control and other pneumatic valve applications. All valves can be through panel mounted for a very clean looking operator interface.

- Single stem design
- Stainless Steel construction
- High flow
- Made in USA

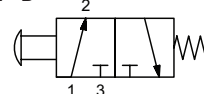


Diagram "A"



3-port, 2-position

Diagram "B"

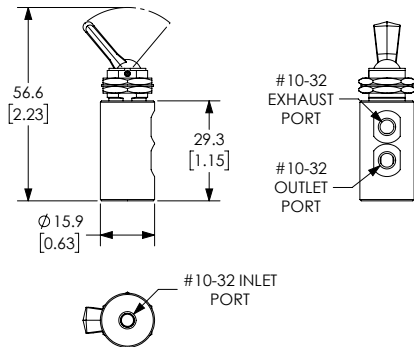


3-port, 2-position

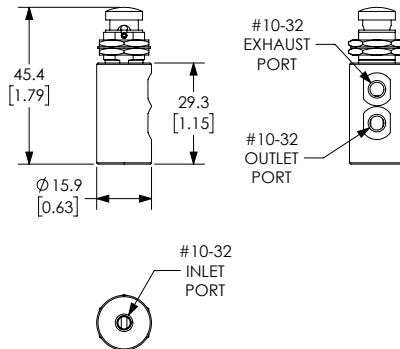
Specifications		
Model	GVS-3C0F-TD-SS	GVS-3C0F-PB-SS
Price	\$29.50	\$28.00
Weight (lbs)	0.1	0.1
Valve Type	3-port (3-way) 2-position	
Acting	Toggle style actuator, normally closed, detented, through panel mount	Pushbutton, normally closed, spring return, through panel mount
Diagram	A	B
Port Size	90-degree ports, #10-32 female threaded inlet(s), #10-32 female threaded outlet(s), #10-32 female threaded exhaust(s)	90-degree ports, #10-32 female threaded inlet(s), #10-32 female threaded outlet(s), #10-32 female threaded exhaust(s)
Flow (Cv)	0.27	0.27
Fluid	Air (to be filtered by 40µ filter element)	
Min. / Max. Pressure	26" Hg to 125 psi (-0.8 to 8.62 bar)	
Temperature	-20°F to 160°F (-51°C to 71°C)	
Lubrication	Not Required	
Body	Brass/ Electroless Nickel, Aluminum/ Anodize, Stainless Steel, Buna-N	
Protection	IP65	

### Dimensions mm [inches]

Note: For panel mounting  
 • Maximum thickness 0.25"  
 • Diameter Ø 0.484 thru



Part No. GVS-3C0F-TD-SS






Part No. GVS-3C0F-PB-SS

See our website [www.AutomationDirect.com](http://www.AutomationDirect.com) for complete Engineering drawings.

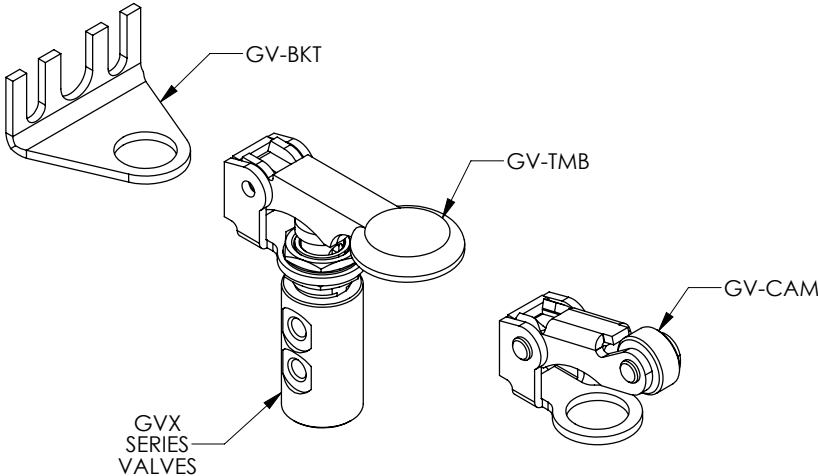


# GVP and GVS Series Pneumatic Valve Accessories



Nitra Pneumatic GVP and GVS Series Pneumatic Valve Accessories				
Item	Part No.	Description	Price	Weight (lbs)
	<b>GV-BKT</b>	NITRA 90 degree mounting bracket, plated steel. For use with all GVP and GVS valves.	\$2.50	0.5
	<b>GV-CAM</b>	NITRA roller cam actuator, plated steel, for use with all GVP and GVS valves. The roller is manufactured from durable acetal plastic. All cams feature a unique acetal pad which minimizes side load and virtually eliminates wear.	\$9.50	0.5
	<b>GV-TMB</b>	NITRA thumb actuator, plated steel, for use with all GVP and GVS valves.	\$10.00	0.5

**Assembly Example**



See our website [www.AutomationDirect.com](http://www.AutomationDirect.com) for complete Engineering drawings.