



# D-Series Heavy Duty Pneumatic Cylinders – Accessories

## D-Series Heavy Duty Pneumatic Cylinder Accessories

<i>Part Number</i>	<i>Description</i>	<i>Pcs/Pkg</i>	<i>Wt (lb)</i>	<i>Price</i>
<b><u>DFM-3</u></b>	NFPA style MF1 or MF2 cylinder flange mounting plate and attaching hardware, for 2-1/2 inch bore NITRA NFPA D-series pneumatic cylinders	1	0.5	Retired



# D-Series Heavy Duty Pneumatic Cylinders – Accessories

## Flange Attachment

### Dimensions

inches [mm]

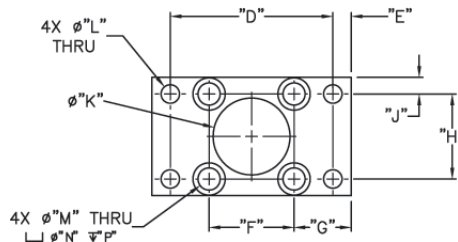
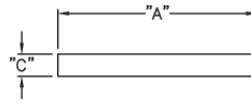

**Flange Attachment Dimension Table**

Part #	A	B	C	D	E	F	G	H	J	(Dia) K	(Dia) L	(Dia) M	(Dia) N	P
<b>DFM-3</b>	4.63 [117.6]	3.00 [76.2]	0.38 [9.7]	3.88 [98.6]	0.38 [9.7]	2.19 [55.6]	1.22 [31.0]	2.19 [55.6]	0.41 [10.4]	ø1.74 [ø44.2]	ø0.38 [ø9.7]	ø0.38 [ø9.7]	ø0.66 [ø16.8]	0.16 [4.1]



# CPS Series Cylinder Position Switches

Position Switch Cross Reference Chart			
NITRA Switch Type	Cylinder Brand (may fit some of these cylinders)	Photo Example	Groove Illustration
CPS CPSF	NITRA A-Series, D-Series, F-Series		
CPS9C	DE-STA-CO Robohand SMC Compact Air		
CPS9D	Fabco Numatics Rotomation		
CPS9F	NITRA G-Series Fabco Festo Numatics Rotomation		
CPS9H	NITRA E-Series NITRA H-Series		
CPS9M	Norgren		
CPS9Q	NITRA G-Series Parker		
CPS9T	SMC		