



# D-Series Heavy Duty Pneumatic Cylinders Accessories



Company Information

Drives

Soft Starters

Motors

Power Transmission

Motion: Servos and Steppers

Motor Controls

Sensors: Proximity

Sensors: Photoelectric

Sensors: Encoders

Sensors: Limit Switches

Sensors: Current

Sensors: Pressure

Sensors: Temperature

Sensors: Level

Sensors: Flow Switches

Pushbuttons and Lights

Stacklights

Signal Devices

Process

Relays and Timers

Pneumatics: Air Prep

Pneumatics: Directional Control Valves

Pneumatics: Cylinders

Pneumatics: Tubing

Pneumatics: Air Fittings

Appendix Book 2

Terms and Conditions

D-Series Heavy Duty Pneumatic Cylinder Accessories				
Part Number	Description	Pcs/Pkg	Wt (lb)	Price
<b>DRC-2</b>	Cylinder rod clevis, 7/16-20 thread, for 1-1/2, 2 and 2-1/2 inch bore NITRA NFPA D-series pneumatic cylinders	1	0.6	\$25.00
<b>DRC-4</b>	Cylinder rod clevis, 3/4-16 thread, for 3-1/4 and 4 inch bore NITRA NFPA D-series pneumatic cylinders	1	1.6	\$41.00
<b>DRE-1</b>	Cylinder rod eye, 7/16-20 thread, for 1-1/2, 2 and 2-1/2 inch bore NITRA NFPA D-series pneumatic cylinders	1	0.4	\$21.50
<b>DRE-2</b>	Cylinder rod eye, 3/4-16 thread, for 3-1/4 and 4 inch bore NITRA NFPA D-series pneumatic cylinders	1	1.2	\$27.00
<b>DPC-1</b>	NFPA style MP2 cylinder rear clevis bracket and attaching hardware, for 1-1/2 inch bore NITRA NFPA D-series pneumatic cylinders	1	0.5	\$20.50
<b>DPC-2</b>	NFPA style MP2 cylinder rear clevis bracket and attaching hardware, for 2 inch bore NITRA NFPA D-series pneumatic cylinders	1	0.7	\$24.50
<b>DPC-3</b>	NFPA style MP2 cylinder rear clevis bracket and attaching hardware, for 2-1/2 inch bore NITRA NFPA D-series pneumatic cylinders	1	0.8	\$29.50
<b>DPC-4</b>	NFPA style MP2 cylinder rear clevis bracket and attaching hardware, for 3-1/4 inch bore NITRA NFPA D-series pneumatic cylinders	1	1.6	\$40.50
<b>DPC-5</b>	NFPA style MP2 cylinder rear clevis bracket and attaching hardware, for 4 inch bore NITRA NFPA D-series pneumatic cylinders	1	1.7	\$46.50
<b>DPA-1</b>	NFPA style MP4 cylinder rear pivot eye and attaching hardware, for 1-1/2 inch bore NITRA NFPA D-series pneumatic cylinders	1	0.4	\$20.00
<b>DPA-2</b>	NFPA style MP4 cylinder rear pivot eye and attaching hardware, for 2 inch bore NITRA NFPA D-series pneumatic cylinders	1	0.5	\$22.50
<b>DPA-3</b>	NFPA style MP4 cylinder rear pivot eye and attaching hardware, for 2-1/2 inch bore NITRA NFPA D-series pneumatic cylinders	1	0.7	\$27.00
<b>DPA-4</b>	NFPA style MP4 cylinder rear pivot eye and attaching hardware, for 3-1/4 inch bore NITRA NFPA D-series pneumatic cylinders	1	1.3	\$40.50
<b>DPA-5</b>	NFPA style MP4 cylinder rear pivot eye and attaching hardware, for 4 inch bore NITRA NFPA D-series pneumatic cylinders	1	1.4	\$44.50
<b>DFM-1</b>	NFPA style MF1 or MF2 cylinder flange mounting plate and attaching hardware, for 1-1/2 inch bore NITRA NFPA D-series pneumatic cylinders	1	0.3	\$19.50
<b>DFM-2</b>	NFPA style MF1 or MF2 cylinder flange mounting plate and attaching hardware, for 2 inch bore NITRA NFPA D-series pneumatic cylinders	1	0.4	\$19.50
<b>DFM-3</b>	NFPA style MF1 or MF2 cylinder flange mounting plate and attaching hardware, for 2-1/2 inch bore NITRA NFPA D-series pneumatic cylinders	1	0.5	\$26.50
<b>DFM-4</b>	NFPA style MF1 or MF2 cylinder flange mounting plate and attaching hardware, for 3-1/4 inch bore NITRA NFPA D-series pneumatic cylinders	1	3.0	\$39.50
<b>DFM-5</b>	NFPA style MF1 or MF2 cylinder flange mounting plate and attaching hardware, for 4 inch bore NITRA NFPA D-series pneumatic cylinders	1	4.3	\$43.50

## Rod Clevis Dimensions

inches [mm]

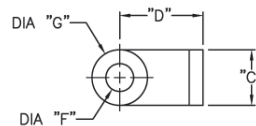
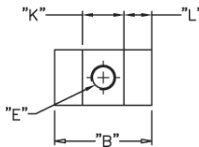
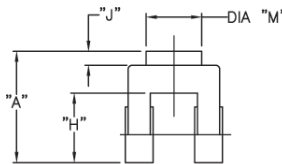

**Note: Comes with Pivot Pin installed.**

**Rod Clevis Dimension Table**

Part #	A	B	C	D	E	(Dia) F	(Dia) G	H	J	K	L	M
DRC-2	2.00 [50.8]	1.75 [44.5]	1.00 [25.4]	1.50 [38.1]	7/16-20	ø0.50 [ø12.7]	ø1.00 [ø25.4]	1.25 [31.8]	0.25 [6.4]	0.75 [19.1]	0.50 [12.7]	ø1.00 [ø25.4]
DRC-4	3.13 [79.5]	2.50 [63.5]	1.50 [38.1]	2.38 [60.5]	3/4-16	ø0.75 [ø19.1]	ø1.50 [ø38.1]	2.00 [50.8]	0.31 [7.8]	1.25 [31.8]	0.63 [16.0]	ø1.50 [ø38.1]

## Rod Eye Dimensions

inches [mm]

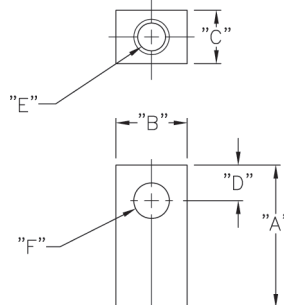

**Rod Eye Dimension Table**

Part #	A	B	C	D	E	(Dia) F
DRE-1	2.00 [50.8]	1.00 [25.4]	0.75 [19.1]	0.50 [12.7]	7/16-20 x 3/4	ø0.50 [ø12.7]
DRE-2	2.81 [71.4]	1.50 [38.1]	1.25 [31.8]	0.75 [19.1]	3/4-16 x 1-1/18	ø0.75 [ø19.1]



# D-Series Heavy Duty Pneumatic Cylinders Accessories

## Rear Clevis Dimensions

inches [mm]

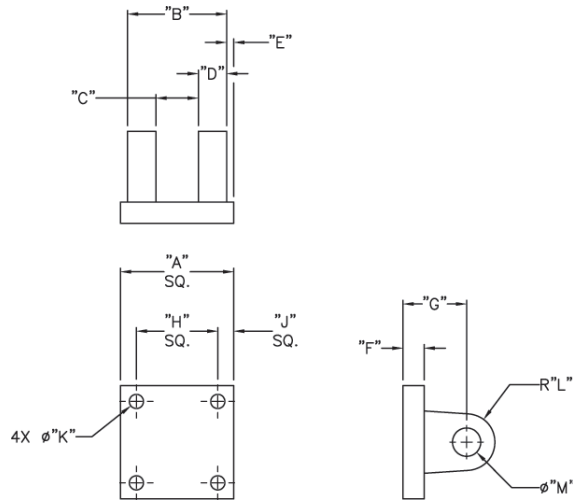

**Note: Comes with pivot pin installed.**

**Rear Clevis Dimension Table**

Part #	A	B	C	D	E	F	G	H	J	(Dia) K	(R) L	(Dia) M
DPC-1	2.00 [50.8]	1.75 [44.5]	0.75 [19.1]	0.50 [12.7]	0.13 [3.3]	0.38 [9.7]	1.13 [28.7]	1.44 [36.6]	0.28 [7.1]	ø0.27 [ø6.9]	R 0.50 [R 12.7]	ø0.50 [ø12.7]
DPC-2	2.50 [63.5]	1.75 [44.5]	0.75 [19.1]	0.50 [12.7]	0.38 [9.7]	0.38 [9.7]	1.13 [28.7]	1.84 [46.7]	0.33 [8.4]	ø0.36 [ø9.1]	R 0.50 [R 12.7]	ø0.50 [ø12.7]
DPC-3	3.00 [76.2]	1.75 [44.5]	0.75 [19.1]	0.50 [12.7]	0.63 [16.0]	0.38 [9.7]	1.13 [28.7]	2.19 [55.6]	0.41 [10.4]	ø0.36 [ø9.1]	R 0.50 [R 12.7]	ø0.50 [ø12.7]
DPC-4	3.75 [95.3]	2.63 [66.8]	1.25 [31.8]	0.63 [16.0]	0.63 [16.0]	0.63 [16.0]	1.88 [47.8]	2.75 [69.9]	0.50 [12.7]	ø0.44 [ø11.2]	R 0.75 [R 19.1]	ø0.75 [ø19.1]
DPC-5	4.50 [114.3]	2.63 [66.8]	1.25 [31.8]	0.63 [16.0]	1.00 [25.4]	0.63 [16.0]	1.88 [47.8]	3.33 [84.6]	0.59 [15.0]	ø0.44 [ø11.2]	R 0.75 [R 19.1]	ø0.75 [ø19.1]

## Rear Pivot Eye Dimensions

inches [mm]

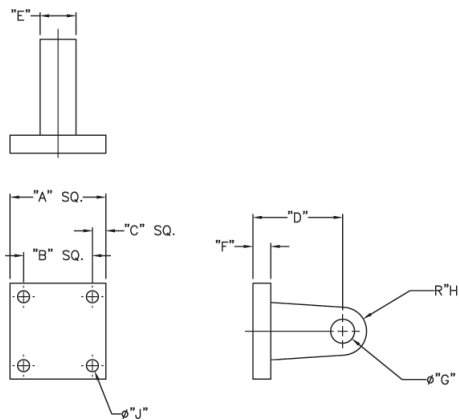

**Rear Pivot Eye Dimension Table**

Part #	A	B	C	D	E	F	(Dia) G	(R) H	(Dia) J
DPA-1	2.00 [50.8]	1.44 [36.6]	0.28 [7.1]	1.13 [28.7]	0.75 [19.1]	0.38 [9.70]	ø0.50 [ø12.7]	R 0.50 [R 12.7]	ø0.27 [ø6.9]
DPA-2	2.50 [63.5]	1.84 [46.7]	0.33 [8.4]	1.13 [28.7]	0.75 [19.1]	0.38 [9.70]	ø0.50 [ø12.7]	R 0.50 [R 12.7]	ø0.36 [ø9.1]
DPA-3	3.00 [76.2]	2.19 [55.6]	0.41 [10.4]	1.13 [28.7]	0.75 [19.1]	0.38 [9.70]	ø0.50 [ø12.7]	R 0.50 [R 12.7]	ø0.36 [ø9.1]
DPA-4	3.75 [95.3]	2.75 [69.9]	0.50 [12.7]	1.88 [47.8]	1.25 [31.8]	0.63 [16.0]	ø0.75 [ø19.1]	R 0.75 [R 19.1]	ø0.44 [ø11.2]
DPA-5	4.50 [114.3]	3.33 [84.6]	0.59 [15.0]	1.88 [47.8]	1.25 [31.8]	0.63 [16.0]	ø0.75 [ø19.1]	R 0.75 [R 19.1]	ø0.44 [ø11.2]



# D-Series Heavy Duty Pneumatic Cylinders Accessories

## Flange Attachment Dimensions

inches [mm]

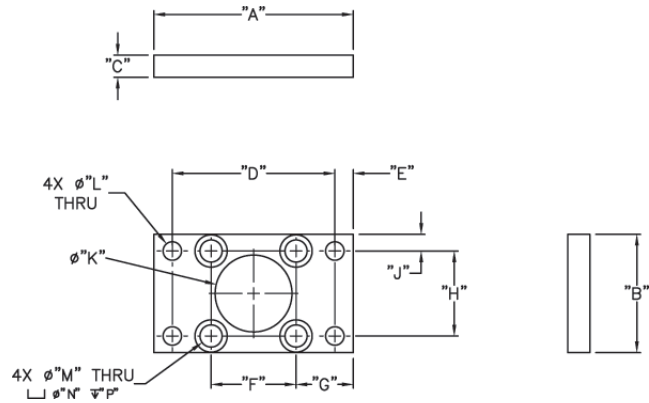

Flange Attachment Dimension Table														
Part #	A	B	C	D	E	F	G	H	J	(Dia) K	(Dia) L	(Dia) M	(Dia) N	P
DFM-1	3.38 [85.9]	2.00 [50.8]	0.38 [9.7]	2.75 [69.9]	0.31 [7.9]	1.44 [36.6]	0.97 [24.6]	1.44 [36.6]	0.28 [7.1]	ø1.30 [ø33.0]	ø0.31 [ø7.9]	ø0.38 [ø9.7]	ø0.66 [ø16.8]	0.16 [4.1]
DFM-2	4.13 [104.9]	2.50 [63.5]	0.38 [9.7]	3.38 [85.9]	0.38 [9.7]	1.84 [46.7]	1.14 [29.0]	1.84 [46.7]	0.33 [8.4]	ø1.30 [ø33.0]	ø0.38 [ø9.7]	ø0.38 [ø9.7]	ø0.66 [ø16.8]	0.16 [4.1]
DFM-3	4.63 [117.6]	3.00 [76.2]	0.38 [9.7]	3.88 [98.6]	0.38 [9.7]	2.19 [55.6]	1.22 [31.0]	2.19 [55.6]	0.41 [10.4]	ø1.74 [ø44.2]	ø0.38 [ø9.7]	ø0.38 [ø9.7]	ø0.66 [ø16.8]	0.16 [4.1]
DFM-4	5.50 [139.7]	3.75 [95.3]	0.63 [16.0]	4.69 [119.1]	0.41 [10.4]	2.75 [69.9]	1.38 [35.1]	2.75 [69.9]	0.50 [12.7]	ø2.06 [ø52.3]	ø0.44 [ø11.2]	ø0.42 [ø10.7]	ø0.82 [ø20.8]	ø0.36 [ø9.1]
DFM-5	6.25 [158.8]	4.50 [114.3]	0.63 [16.0]	5.44 [138.2]	0.41 [10.4]	3.33 [84.6]	1.46 [37.1]	3.33 [84.6]	0.59 [15.0]	ø2.06 [ø52.3]	ø0.44 [ø11.2]	ø0.42 [ø10.7]	ø0.82 [ø20.8]	ø0.36 [ø9.1]

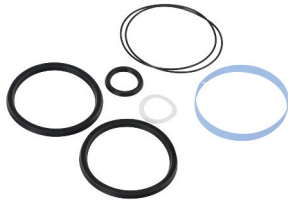

D-Series Heavy Duty Pneumatic Cylinder Replacement Seal Kit				
Part Number	Description	Pcs/Pkg	Wt (lb)	Price
<b>DSK-24</b>	Seal kit, replacement, for NITRA D24 series pneumatic cylinders. Includes 4 Buna-N seals and PTFE rod wiper and wear strip.	1	0.1	\$15.00
<b>DSK-32</b>	Seal kit, replacement, for NITRA D32 series pneumatic cylinders. Includes 4 Buna-N seals and PTFE rod wiper and wear strip.	1	0.1	\$16.00
<b>DSK-40</b>	Seal kit, replacement, for NITRA D40 series pneumatic cylinders. Includes 4 Buna-N seals and PTFE rod wiper and wear strip.	1	0.1	\$18.00
<b>DSK-52</b>	Seal kit, replacement, for NITRA D52 series pneumatic cylinders. Includes 4 Buna-N seals and PTFE rod wiper and wear strip.	1	0.2	\$19.00
<b>DSK-64</b>	Seal kit, replacement, for NITRA D64 series pneumatic cylinders. Includes 4 Buna-N seals and PTFE rod wiper and wear strip.	1	0.2	\$21.00

Company Information

Drives

Soft Starters

Motors

Power Transmission

Motion: Servos and Steppers

Motor Controls

Sensors: Proximity

Sensors: Photoelectric

Sensors: Encoders

Sensors: Limit Switches

Sensors: Current

Sensors: Pressure

Sensors: Temperature

Sensors: Level

Sensors: Flow Switches

Pushbuttons and Lights

Stacklights

Signal Devices

Process

Relays and Timers

Pneumatics: Air Prep

Pneumatics: Directional Control Valves

Pneumatics: Cylinders

Pneumatics: Tubing

Pneumatics: Air Fittings

Appendix Book 2

Terms and Conditions