

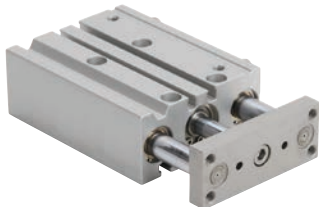

# E-Series Dual Guide Rod Cylinders

## 16 mm Bore, Double Acting



Part No. E16M050MD-M

16 mm Bore E-Series Dual Guide Rod Cylinders - Double Acting					
Part Number	Stroke Length (mm)	"A" (mm [in])	"B" (mm [in])	Weight (lbs)	Price
E16M010MD-M	10	43.0 [1.69]	-3.0 [-0.12]	0.8	\$128.00
E16M020MD-M	20	53.0 [2.09]	-3.0 [-0.12]	0.9	\$128.00
E16M025MD-M	25	58.0 [2.28]	-3.0 [-0.12]	1.0	\$138.00
E16M030MD-M	30	63.0 [2.48]	-3.0 [-0.12]	1.0	\$138.00
E16M040MD-M	40	73.0 [2.87]	-3.0 [-0.12]	1.2	\$138.00
E16M050MD-M	50	83.0 [3.27]	-3.0 [-0.12]	1.3	\$138.00
E16M075MD-M	75	108.0 [4.25]	19.0 [0.75]	1.7	\$146.00
E16M100MD-M	100	133.0 [5.27]	19.0 [0.75]	2.0	\$161.00
E16M125MD-M	125	158.0 [6.22]	49.0 [1.93]	2.3	\$172.00
E16M150MD-M	150	183.0 [7.20]	49.0 [1.93]	2.6	\$178.00
E16M175MD-M	175	208.0 [8.19]	49.0 [1.93]	2.9	\$187.00
E16M200MD-M	200	233.0 [9.17]	49.0 [1.93]	3.2	\$189.00

### Dimensions

mm [in]

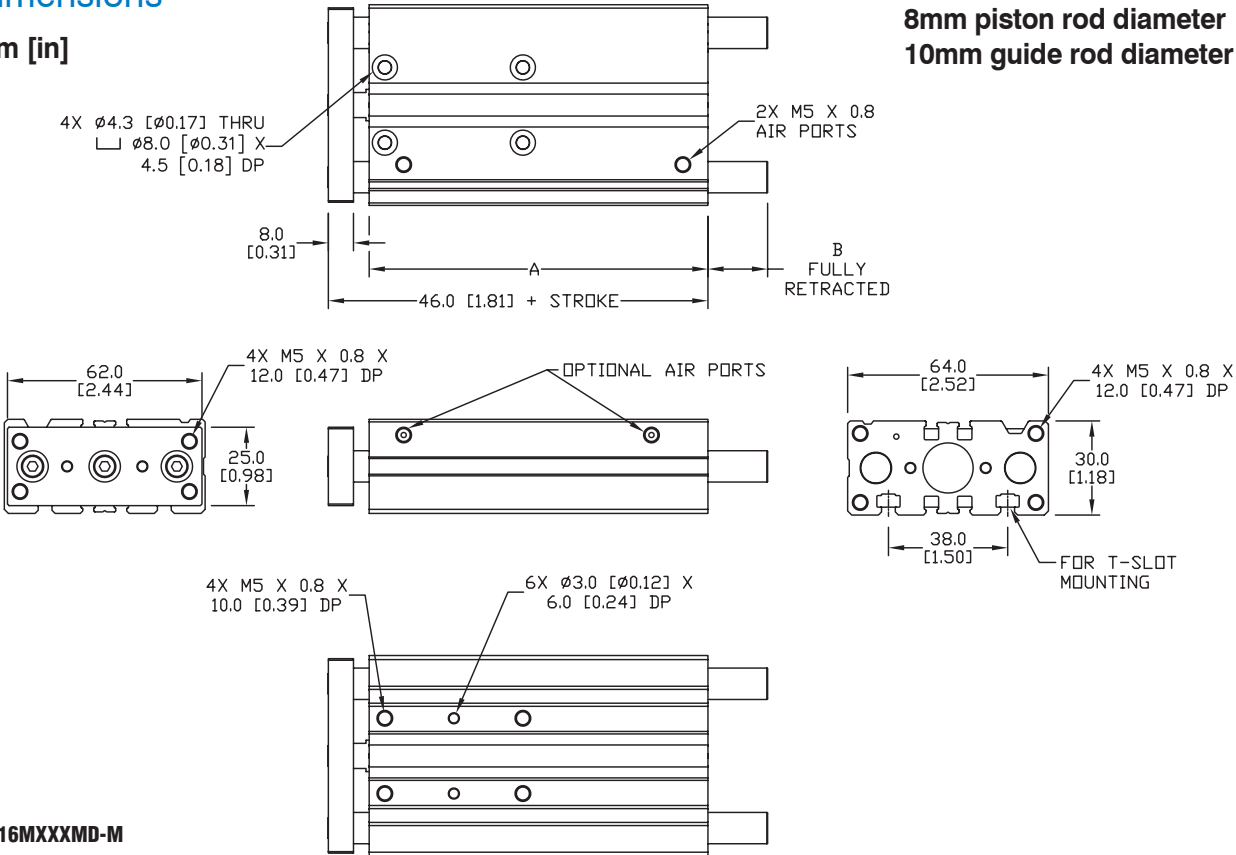

See our website [www.AutomationDirect.com](http://www.AutomationDirect.com) for complete Engineering drawings.



# E-Series Dual Guide Rod Cylinders - Load and Torque Ratings

Cylinder Max Side Load Ratings (lbs)													
Bore Size (mm)	Stroke (mm)												
	10	20	25	30	40	50	75	100	125	150	175	200	250
12	9.9	7.4	6.5	5.9	9.2	8.1	5.9	5.0	4.3	3.8	-	-	-
16	15	11	9.5	8.3	14	13	8.3	7.2	6.1	5.4	5.0	4.5	-
20	-	18	14	13	28	25	20	17	15	13	12	11	9.5
25	-	21	20	17	32	29	23	19	20	18	16	15	12
32	-	-	46	43	40	37	41	35	32	29	26	24	20
40	-	-	46	43	40	37	41	35	32	29	26	24	20
50	-	-	67	64	60	55	61	54	49	44	40	37	32
63	-	-	67	64	60	55	61	54	49	44	40	37	32

Conversion: 1 lb = 4.45 N

Cylinder Max Torque Ratings (in-lb)													
Bore Size (mm)	Stroke (mm)												
	10	20	25	30	40	50	75	100	125	150	175	200	250
12	7.97	6.99	6.28	5.75	6.82	6.37	4.43	3.19	2.74	2.39	-	-	-
16	10.7	9.20	8.32	7.79	10.89	9.82	6.11	5.13	4.43	3.89	3.54	3.19	-
20	-	13.9	12.6	11.6	21.2	19.0	16.6	14.4	12.7	11.3	10.3	9.38	7.97
25	-	21.2	19.6	17.8	32.4	29.7	26.2	22.7	20.0	17.9	16.2	14.8	12.6
32	-	-	56.2	53.1	50.7	45.4	50.4	44.0	39.1	35.2	32.0	29.3	25.1
40	-	-	62.0	58.4	54.1	50.1	55.5	48.5	43.1	38.8	35.2	32.3	27.7
50	-	-	115	112	97.4	95.6	106	93.8	84.1	76.1	69.6	64.1	55.2
63	-	-	130	120	114	107	119	105	94.7	85.8	78.4	72.2	62.3

Conversion: 1 in-lb = 0.113 N-m



# E-Series Dual Guide Rod Cylinders

Fittings can be mounted in either the top or the side of the cylinder (2 plugs included with each cylinder).

Magnetic switches can be mounted on the top or bottom of the cylinders

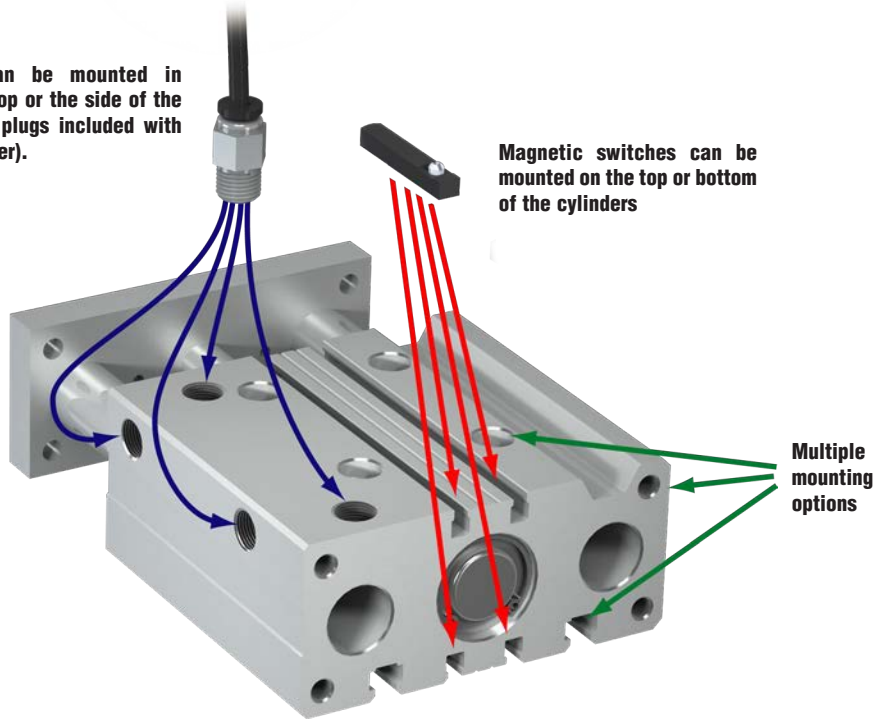

Multiple mounting options

NITRA pneumatic guided actuator with dual guide rods, bronze bushings, extruded aluminum housing and switch mounting tracks.

- Eight bore sizes
- Interchangeable with other popular brands
- Work with 4mm square T-slot cylinder switches
- Chrome plated stainless steel guide rods
- Mild steel tooling plate
- Nitrile / Buna-N O-rings













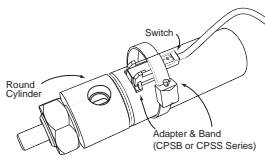
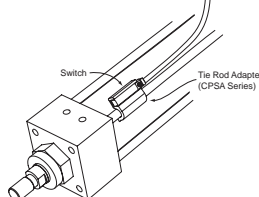

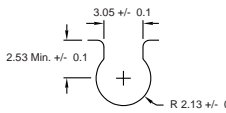
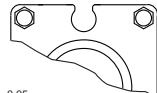
**E-Series Dual Guide Rod Cylinder Specifications**

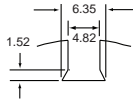
Bore Size (mm)	12	16	20	25	32	40	50	63
Action	Double acting							
Fluid	Air (clean/dry)							
Temperature Range	23 to 158°F (-5 to 70°C)							
Pressure Range	18-142 psi (1.2-10 bar)							
Proof Pressure	213 psi (15 bar)							
Lubrication	Not required							
Cushion Type	Urethane Bumper							
Non-Rotate Tolerance	±0.10°		±0.09°		±0.08°		±0.06°	
Port Size	M5x0.8		1/8-NPT				1/4-NPT	
Extend Force @ 100 psi (lbs.)	17.5	31.2	48.7	76.1	124.7	194.8	304.3	483.2
Retract Force @ 100 psi (lbs.)	9.7	19.0	31.2	44.9	76.0	146.1	255.6	434.5

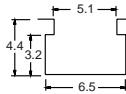
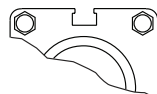

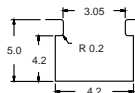
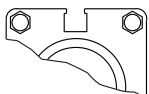
# CPS Series Cylinder Position Switches

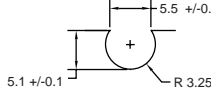
**Position Switch Cross Reference Chart**

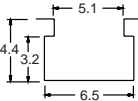
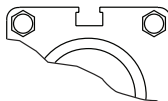
NITRA Switch Type	Cylinder Brand (may fit some of these cylinders)	Photo Example	Groove Illustration	
<p><b>CPS</b> <b>CPSF</b></p>	<p>NITRA A-Series, D-Series, F-Series</p>			
<p><b>CPS9C</b></p>	<p>DE-STA-CO Robohand SMC Compact Air</p>			
<p><b>CPS9D</b></p>	<p>Fabco Numatics Rotomation</p>			
<p><b>CPS9F</b></p>	<p>NITRA G-Series Fabco Festo Numatics Rotomation</p>			
<p><b>CPS9H</b></p>	<p>NITRA E-Series NITRA H-Series</p>			
<p><b>CPS9M</b></p>	<p>Norgren</p>			
<p><b>CPS9Q</b></p>	<p>NITRA G-Series Parker</p>			
<p><b>CPS9T</b></p>	<p>SMC</p>	