

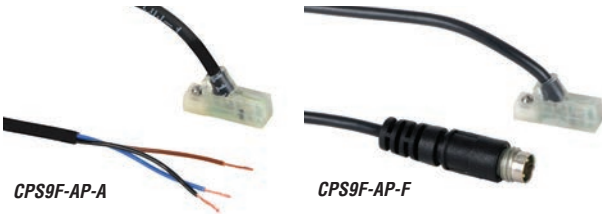

CPS9F Series Cylinder Position Switches

NITRA CPS9F Series cylinder position switches are general purpose switches for use with cylinders having a magnetic piston. The switches are designed to mount on cylinders with 6.5 x 3.2 mm T-slots.



NITRA CPS9F Series Cylinder Position Switches			
Part No.	Description	Price	Weight (lbs)
CPS9F-AP-A	Pneumatic cylinder switch, for position sensing, magnetic, rectangular, normally open, 3-wire, 5-28 VDC, electronic PNP transistor output, status LED, 9.8 ft. (3.0m) cable with wire leads. Can be mounted on cylinders with 6.5 x 3.2 mm T-slots.	\$12.00	0.2
CPS9F-AN-A	Pneumatic cylinder switch, for position sensing, magnetic, rectangular, normally open, 3-wire, 5-28 VDC, electronic NPN transistor output, status LED, 9.8 ft. (3.0m) cable with wire leads. Can be mounted on cylinders with 6.5 x 3.2 mm T-slots.	\$12.00	0.2
CPS9F-AP-F	Pneumatic cylinder switch, for position sensing, magnetic, rectangular, normally open, 3-wire, 5-28 VDC, electronic PNP transistor output, status LED, 0.5 ft. (0.15m) cable with M8 snap-fit connector. Can be mounted on cylinders with 6.5 x 3.2 mm T-slots.	\$12.00	0.2
CPS9F-AN-F	Pneumatic cylinder switch, for position sensing, magnetic, rectangular, normally open, 3-wire, 5-28 VDC, electronic NPN transistor output, status LED, 0.5 ft. (0.15m) cable with M8 snap-fit connector. Can be mounted on cylinders with 6.5 x 3.2 mm T-slots.	\$12.00	0.2

Wiring

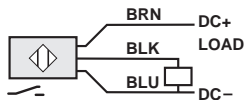

CPS9F-AP-A

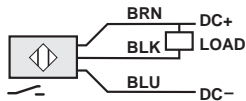

CPS9F-AN-A

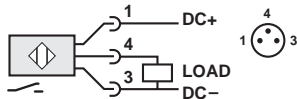

CPS9F-AP-F

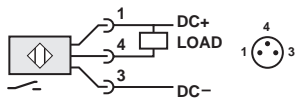

CPS9F-AN-F

NITRA CPS9F Series Cylinder Switch Specifications	
Operating Voltage	5-28 VDC
Voltage Drop	1.0 V
Current Rating	0.2 Amps Max.
Wire Size	26AWG (0.13mm ²)
Switching Power	4.8 watts Max.
Switching Speed	4µs operate / 4µs release
Short Circuit Protection	No
Reverse Polarity Protection	Yes
Overload Protection	No
Leakage Current	< 0.01 mA
Sensing Technology	GMR
Off Delay Time	150-200 ms
Function Display	PNP switching status yellow / NPN switching status red
Switching Frequency	< 1000 Hz
Magnetic Sensitivity	2.5 millitesla (25 gauss)
Housing Materials	Zytel
Operating Temperature	-4°F to 176°F (-20°C to 80°C)
Protection Rating	NEMA 6 / IP 67
Agency Approvals	CE, RoHS, REACH

Dimensions

mm [inches]

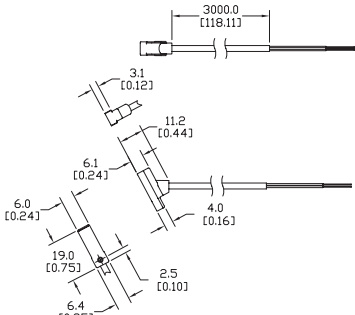

CPS9F-xx-A wire length tolerance +12" / - 0"

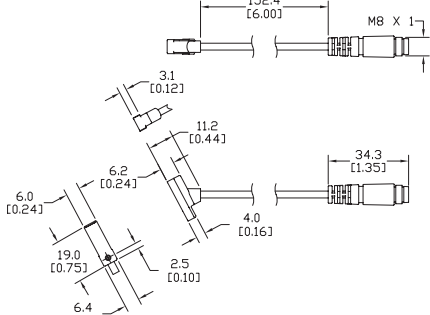

CPS9F-xx-F cable length tolerance ± 1.5"



CPS Series Cylinder Position Switches

The NITRA CPS Series of cylinder position switches offers a robust, yet cost-effective, interface between pneumatic or hydraulic actuators and electrical control systems. Using state-of-the-art magnetic sensing technology, these switches are designed for use with cylinders that have a magnet incorporated in the cylinder piston. They can be used to provide cylinder position indication, cycle count, or to confirm operation.

NITRA cylinder position switches are now available in nine styles with accessories to fit many different styles of cylinders or actuators. The switches are designed for general purpose applications on most popular cylinder brands with sensor grooves, on round body cylinders using CPSB Series mounting bands or on tie rod cylinders using CPSA Series adapters. Harsh duty applications can use the CPSF Series switches with CPSS stainless steel mounting bands if needed.

NITRA cylinder position switches are available in 3-wire DC, PNP normally open, PNP normally closed, and NPN normally open electronic solid state configurations. Switches include integral cable with either an M8 or M12 wiring connector or wire leads. Integral LED indication provides switch status for speedy switch positioning and troubleshooting. Pre-tested for use with NITRA pneumatic cylinders, these switches are also suitable for use with other brands of cylinders with magnetic pistons.

Features

- Electronic switch output, PNP (normally open or normally closed) or NPN (normally open)
- Solid state reliability, no moving parts for longer life
- AMR sensing technology with small hysteresis for precise sensing
- GMR sensing technology for basic industrial applications
- Compact and easy to mount on round body, tie rod, and extruded body cylinders
- LED switch status indication
- Integral cable with M8 or M12 wiring connector or 2-meter wire leads
- Electronic switch performance at reed switch prices



CPSB Band Assembly



CPSA Adapter Assembly



E-series cylinder with switch

Technology Comparison

Reed Switch vs. AutomationDirect CPS Series Electronic Switch			
	Mechanical Reed Switch	AutomationDirect CPS Series Electronic Switch	Details
Durability	low (1-2 million cycles typical)	high (virtually unlimited number of cycles)	Reed switches can stick, break, bounce and are prone to wear
Repeatability	low	high	Mechanical wear of reed switches can lead to switch point drift
Response time	low	high	Reed switches have a slower response time than electronic switches, resulting in lower switch accuracy
Sensitivity to magnetic fields	low	high	Electronic sensors, more sensitive than reed switches, operate reliably even with weak magnetic fields
Temperature stability	high	high	Both switch technologies are extremely stable over the entire temperature range
Longevity	low	high	Electronic sensors are insensitive to long term effects of magnetic fields. Reed switches can become permanently magnetized over time.
Response sensitivity	medium	high	Electronic sensors have small hysteresis and are exceptional for short stroke cylinders
Price	low	low	Reed switches are usually much less expensive than electronic switches. The AutomationDirect CPS Series offers all the advantages of an electronic cylinder position switch at reed switch prices.

AMR vs. GMR Technology

Two solid state magnetic sensing technologies used for pneumatic cylinder position are GMR (Giant Magnetoresistive) and AMR (Anisotropic Magnetoresistive). Both sensing technologies consist of layers of ferromagnetic material that change in electrical resistance when exposed to an external magnetic field.

AMR based switches have a higher sensitivity and narrower sensing field compared to less expensive GMR based switches. AMR switches are a better choice for cylinders with short strokes.



CPS Series Cylinder Position Switches

Position Switch Cross Reference Chart			
NITRA Switch Type	Cylinder Brand (may fit some of these cylinders)	Photo Example	Groove Illustration
CPS CPSF	NITRA A-Series, D-Series, F-Series		
CPS9C	DE-STA-CO Robohand SMC Compact Air		
CPS9D	Fabco Numatics Rotomation		
CPS9F	NITRA G-Series Fabco Festo Numatics Rotomation		
CPS9H	NITRA E-Series NITRA H-Series		
CPS9M	Norgren		
CPS9Q	NITRA G-Series Parker		
CPS9T	SMC		