

IDEM MPC and MMC Non-Contact Coded Magnetic Safety Switches

MPC Series Plastic Housing

MMC Series Stainless Housing



- Coded magnetic actuation
- Compact yet robust fitting suitable for all small guard applications
- Hygienic screw cap covers ensure suitability for food processing washdown
- Cost effective interlock solution
- Can be mounted unobtrusively in channels or behind doors - left or right cable exit
- High specification polyester housing with backplate
- LED indication
- Can be high-pressure hosed at high temperature - IP69K rated
- Sensing distance up to 10 mm
- Switching capability up to 0.2A
- Will operate with most safety relays
- Available with 2m, 5m, or 10m cable or 250mm pigtail with quick-disconnect cable

MMC Series only

- Specifically designed for food processing applications
- Suitable for CIP SIP cleaning - Food Splash Zones per EHEDG guidelines
- 316 Stainless steel mirror polished finish

See Dimensions later in this section.

Actuator Operating Direction

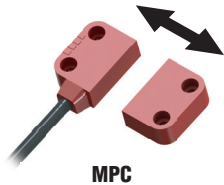

MPC and MMC Non-Contact Coded Magnetic Safety Switches					
Part Number	Price	Body Material	Cable Length / Exit Type	Circuits	Contact Rating
Pigtail Versions					
MPC-114105	\$74.00	Plastic	2m / Right	2 NC, 1 NO	0.2A
MPC-114106	\$84.00		5m / Right		
MPC-114107	\$98.00		10m / Right		
MPC-114113	\$74.00		2m / Left		
MPC-114114	\$84.00		5m / Left		
MPC-114115	\$98.00		10m / Left		
MMC-H-131105	\$135.00	Stainless Steel	2m / Right		
MMC-H-131106	\$142.00		5m / Right		
MMC-H-131107	\$155.00		10m / Right		
MMC-H-131117	\$135.00		2m / Left		
MMC-H-131118	\$142.00		5m / Left		
MMC-H-131119	\$155.00		10m / Left		
Quick Disconnect Versions (M12 8-pin)					
MPC-114108	\$106.00	Plastic	250mm / Right	2 NC, 1 NO	0.2A
MPC-114116	\$106.00		250mm / Left		
MMC-H-131108	\$160.00	Stainless Steel	250mm / Right		
MMC-H-131120	\$160.00		250mm / Left		

Female Quick Disconnect Lead			
Part Number	Price	Description	Exit Type/Cable Length
140101	\$31.00	Female QD Lead	M12 Female 5m, 8-pin
140102	\$39.00		M12 Female 10m, 8-pin



IDEM MPC and MMC Non-Contact Coded Magnetic Safety Switches

Dimensions

mm [inch]

MPC Series

Right Pigtail

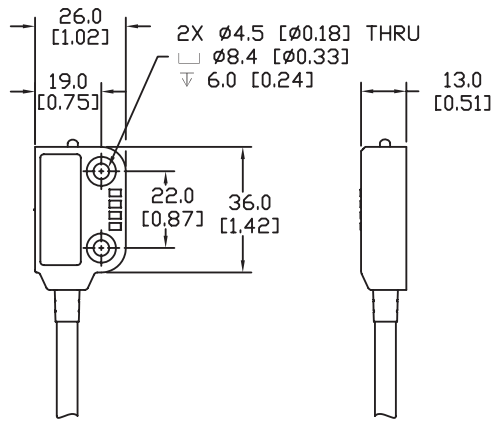

SWITCH

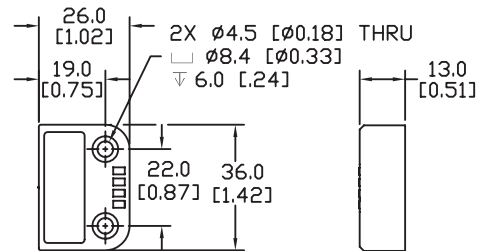

ACTUATOR

Right Quick Disconnect

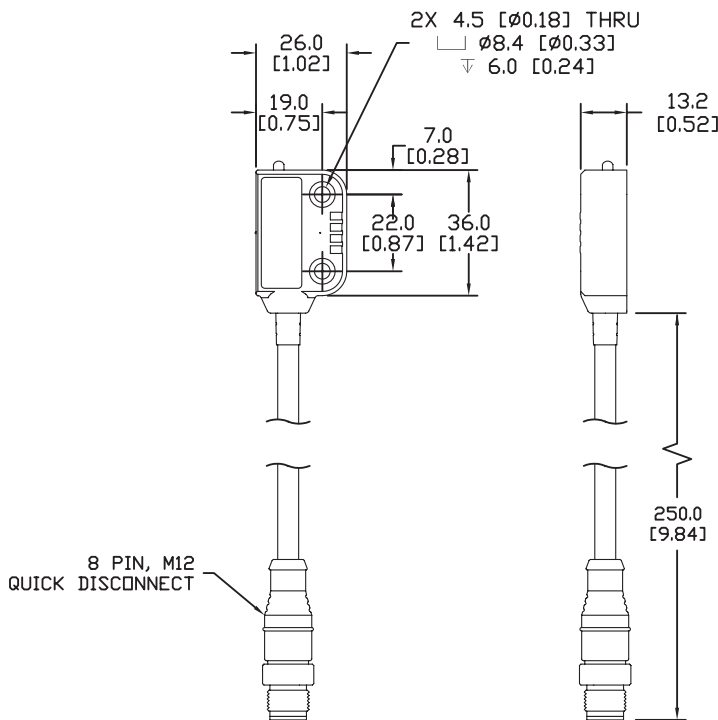

SWITCH

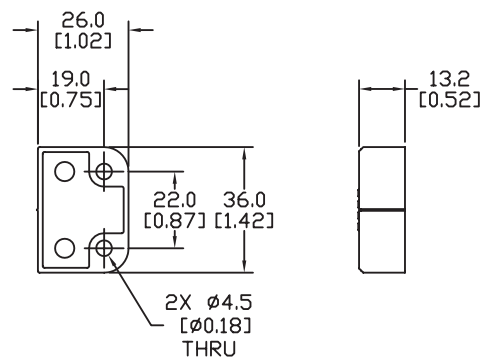

ACTUATOR

SEE OUR WEBSITE: WWW.AUTOMATIONDIRECT.COM FOR COMPLETE ENGINEERING DRAWINGS.

IDEM MPC and MMC Non-Contact Coded Magnetic Safety Switches

Dimensions

mm [inch]

MPC Series

Left Pigtail

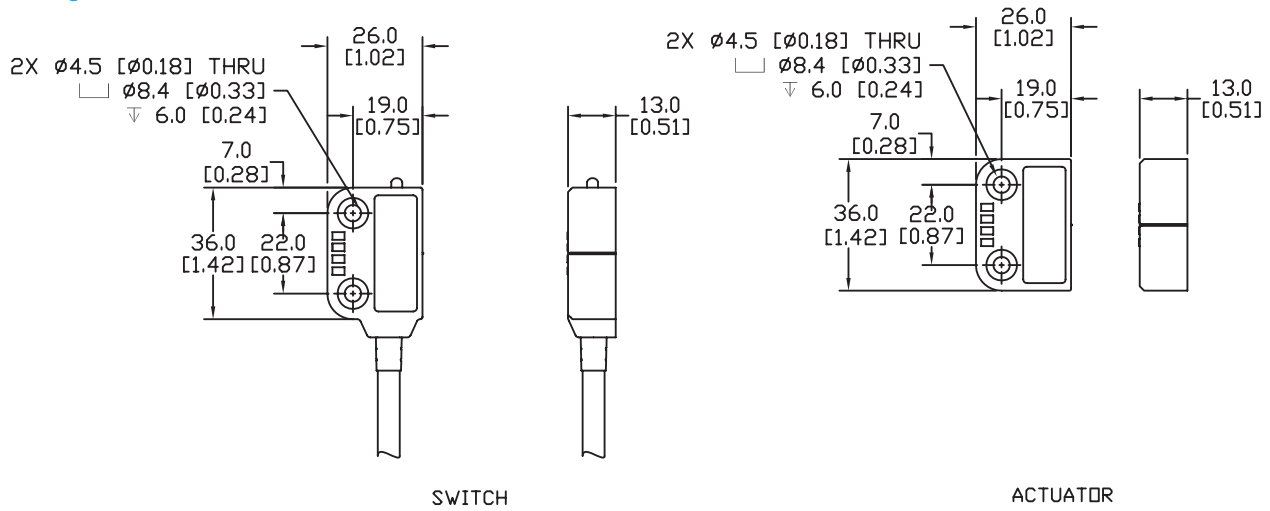

Left Quick Disconnect

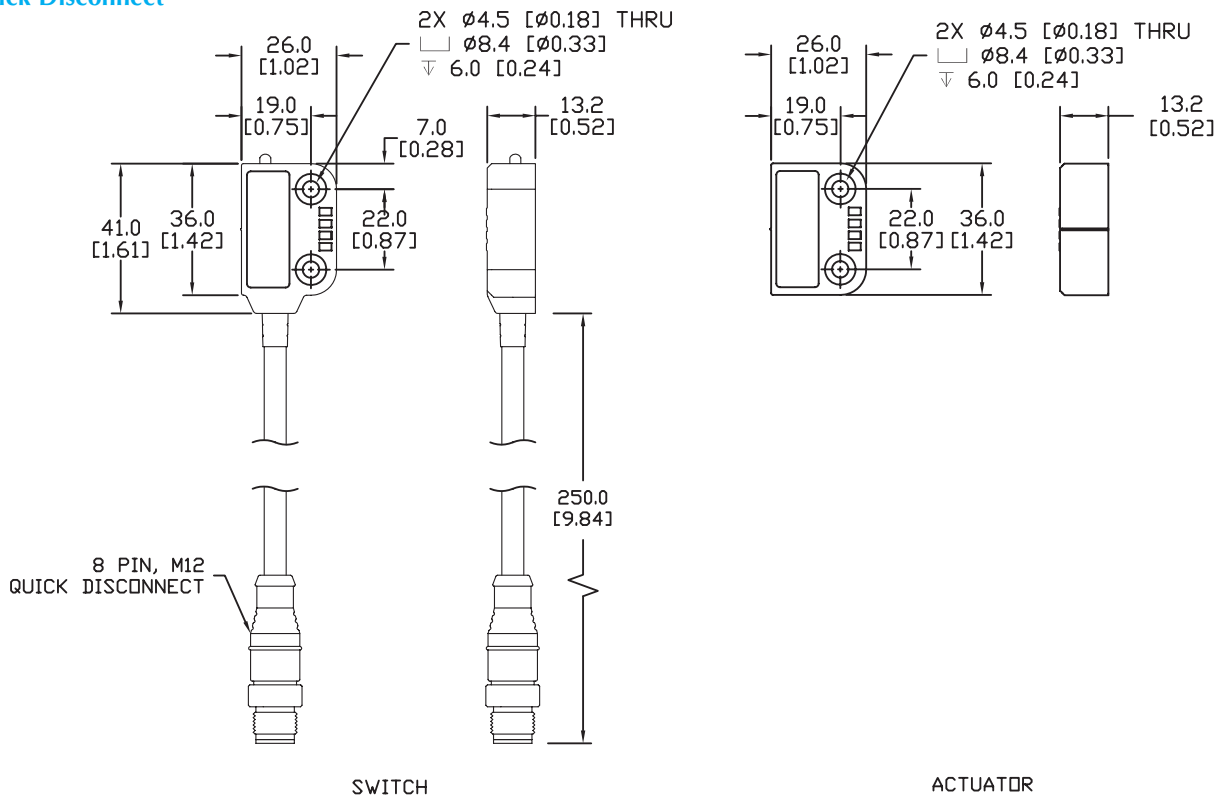

SEE OUR WEBSITE: WWW.AUTOMATIONDIRECT.COM FOR COMPLETE ENGINEERING DRAWINGS.

IDEM MPC and MMC Non-Contact Coded Magnetic Safety Switches

Dimensions

mm [inch]

MMC Series

Right Pigtail

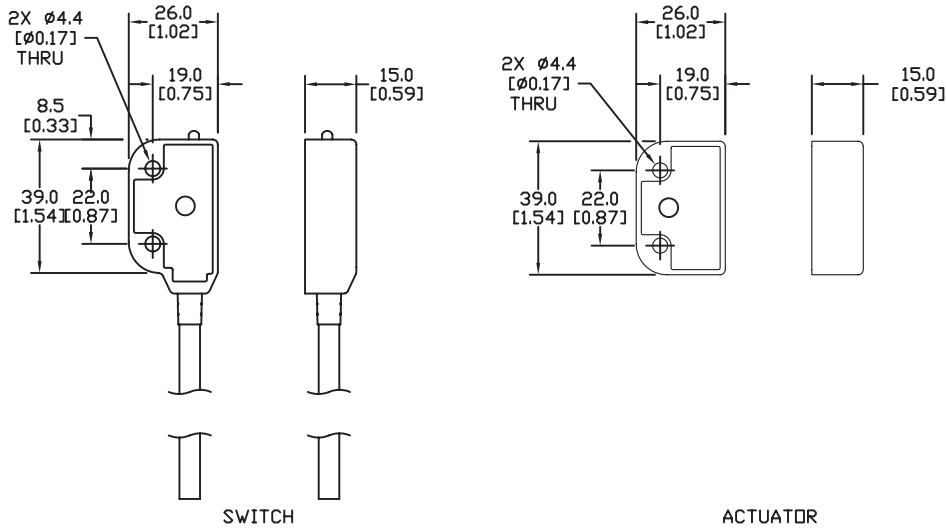

Right Quick Disconnect

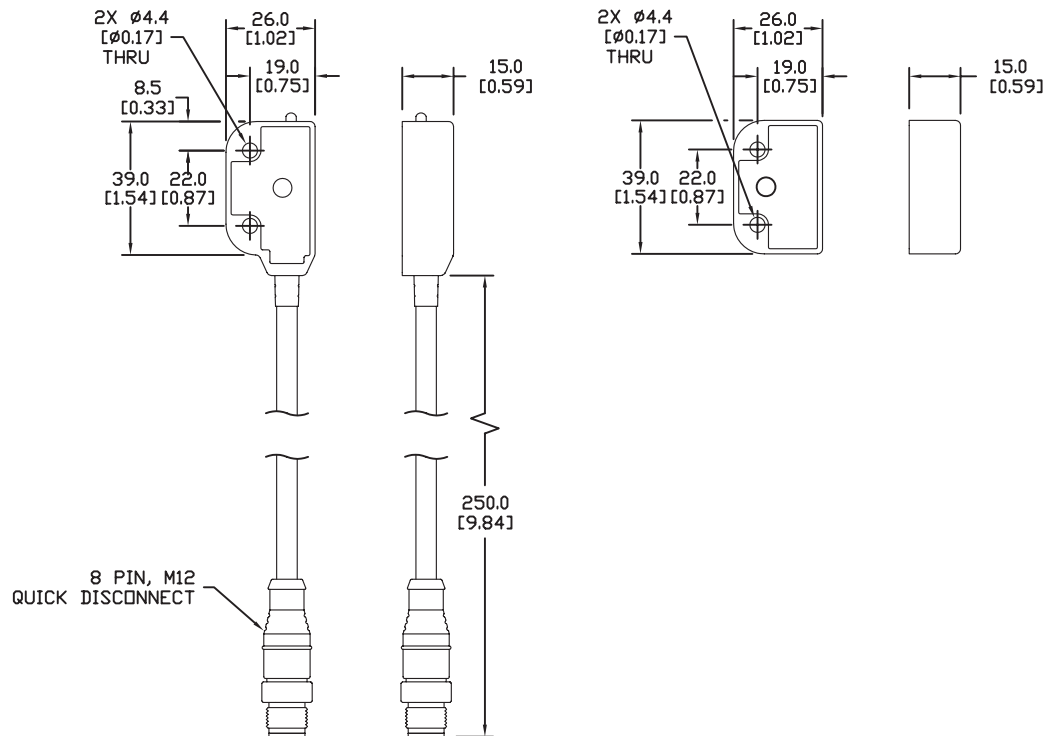

SEE OUR WEBSITE: WWW.AUTOMATIONDIRECT.COM FOR COMPLETE ENGINEERING DRAWINGS.

IDEM MPC and MMC Non-Contact Coded Magnetic Safety Switches

Dimensions

mm [inch]

MMC Series

Left Pigtail

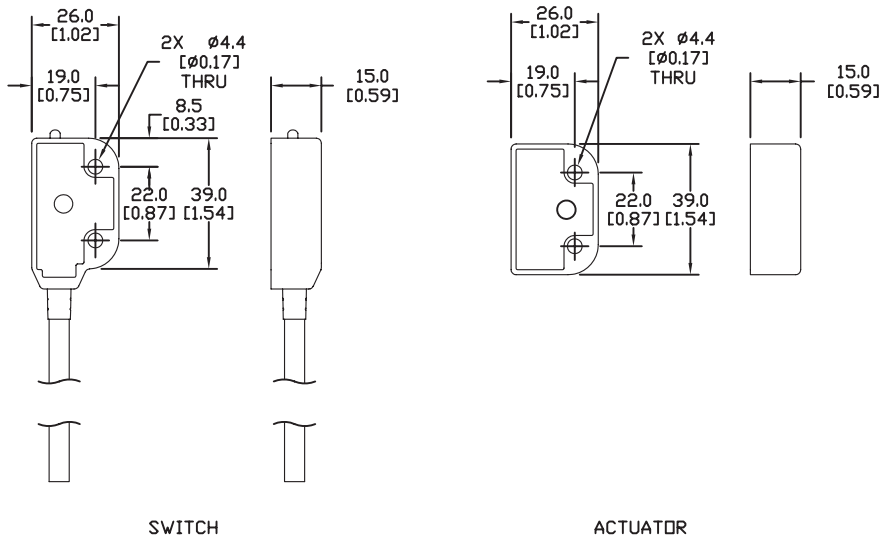

Left Quick Disconnect

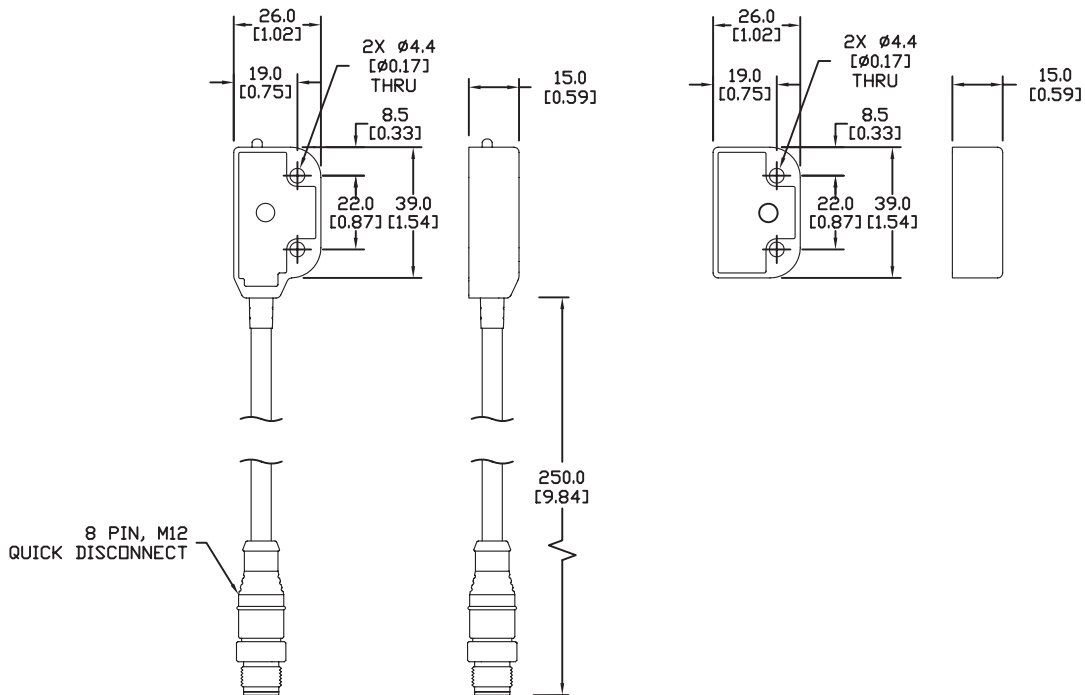

SEE OUR WEBSITE: WWW.AUTOMATIONDIRECT.COM FOR COMPLETE ENGINEERING DRAWINGS.

IDEM Non-Contact Safety Switches Electrical Connections and Dimensions

Electrical Connections

Magnetic Switches

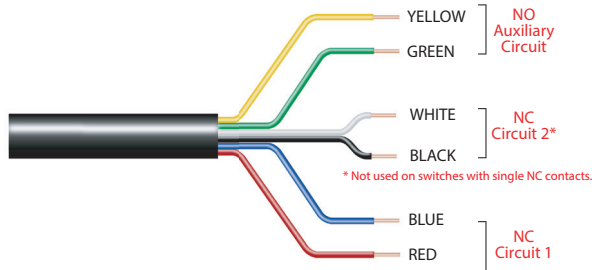

Magnetic Switches - Electrical Connections		
Quick Disconnect Connector Pin Out	Lead Color	Type of Circuit (Actuator Present)
4	Yellow	NO
6	Green	NO
7	Black	NC2
1	White	NC2
2	Red	NC1
3	Blue	NC1

Coded Magnetic and RFID Switches

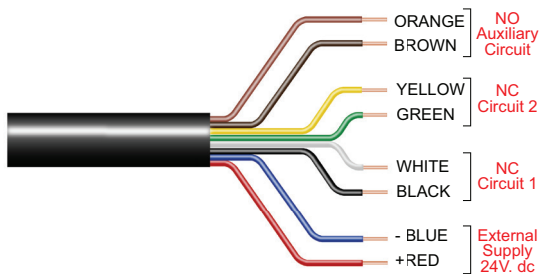

Coded Magnetic Switches - Electrical Connections			
Quick Disconnect Connector Pin Out	Lead Color	Type of Circuit (Actuator Present)	Output Types (Solid State)
8	Orange	Auxiliary (NO)	200 mA max. 24 VDC
5	Brown	Auxiliary (NO)	
4	Yellow	NC2 +	200 mA max. 24 VDC (Optocoupler)
6	Green	NC2 -	
7	Black	NC1 +	200 mA max. 24 VDC (Optocoupler)
1	White	NC1 -	
2	Red	Supply +24 VDC	Supply 24 VDC +10% / -15%
3	Blue	Supply 0VDC	

Connection Colors

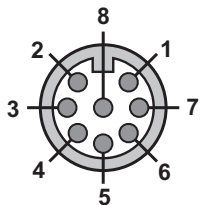

Pin View from Switch
M12 Male

IDEM Non-Contact Safety Switches Specifications

Non-contact Safety Switches Specifications			
	Non-Contact Magnetic Switches	Non-Contact Coded Magnetic Switches	Non-Contact RFID Coded Switches
Safety Classification and Reliability Data			
Switching Reliability (B10d)	3.3 x 10 ⁶ operations at 100 mA load		No mechanical parts implemented
ISO 13849-1	Up to category 4 with safety relay		
ISO 13849-1	Up to PLe depending upon system architecture		
EN 62061	Up to SIL3 depending upon system architecture		
Safety Data - Annual Usage	8 cycles per hour / 24 hours per day / 365 days		
PFHd	2.8 x 10 ⁻¹⁰	2.6 x 10 ⁻¹⁰	4.77 x 10 ⁻¹⁰
Proof Test Interval (Life)	20 Years		
MTTFd	866 Years		1100 years
Agency Approvals	CE, cULus		
Electrical and General Specifications			
Contact Ratings: Safety Contact NC	MPPR: Voltage free: 250 VAC, 0.5 A Max.	24 VDC, 0.2A Max. (Optocoupler)	
	LPR, LMR, SPR, SMR, SMR-F: Voltage free: 250 VAC, 1.0A Max.		
Contact Ratings: Monitoring (Auxiliary) Contact NO	CPR, CMR, CMR-F, WPR: Voltage free: 250 VAC, 2.0A Max.	24 VDC, 0.2A Max.	
	Voltage free: 24 VDC, 0.2A Max.		
Recommended Fuses (NC Circuits)	MPPR: Fuse externally 0.4A (F)	NA	
	LPR, LMR, SPR, SMR, SMR-F, CMR, CMR-F: Fuse externally 0.8A (F)		
	CPR, WPR: Fuse externally 1.6A (F)		
Contact Release Time	<2ms	NA	
Initial Contact Resistance	<500 milliohm	NA	
Minimum Switched Current	10 VDC, 1mA		
Dielectric Withstand	250 VAC		
Insulation Resistance	100 Megohms		
Recommended Setting Gap	5mm		
NC Switching Distance	Sao (assured ON) 8mm close; Sar (assured OFF) 20 mm open		
NO Switching Operation	Opens before NC circuits close		
Tolerance to Misalignment	5mm in any direction from 5mm setting gap (See Misalignment Range drawing on this page)		
Switching Frequency	1.0 Hz Max.		
Approach Speed	200 mm per minute to 1000 mm per second		
Body Material - Polyester	CPR, LPR, MPPR, SPR, WPR	CPC, LPC, MPC, SPC, WPC	LPF, SPF
Body Material - 316 Stainless Steel	CMR, CMR-F, LMR, SMR, SMR-F	CMC, CMC-F, LMC, SMC, SMC-F	NA
Operating Temperature Range	Polyester: -25° to +80°C (-13° to +176° F)		
	316 Stainless Steel: -25° to +105° C (-13° to +221° F)		NA
Storage Temperature (Low)	-55° to -40° C (-67° to -40° F)		
Enclosure Protection	IP67, IP69K		
Shock Resistance	IEC 68-2-27 11 ms 30g		
Vibration Resistance	IEC 68-2-6 10-55 Hz 1mm		
Cable Type	PVC, 6.5 mm outside diameter max.		PVC, 6mm outer diameter max.
Mounting Bolts (recommended)	2 x M4; Tightening torque: 1.0 Nm		

Note: Always mount onto non-Ferrous materials.

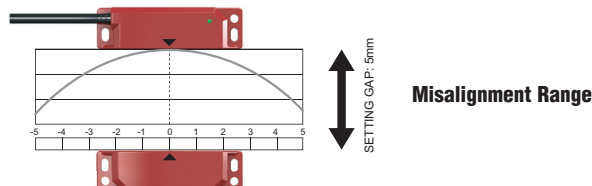

Safety Products



Warning: Safety products sold by AutomationDirect are Safety components only. The purchaser/installer is solely responsible for the application of these components and ensuring all necessary steps have been taken to assure each application and use meets all performance and applicable safety requirements and/or local, national and/or international safety codes as required by the application. AutomationDirect cannot certify that our products, used solely or in conjunction with other AutomationDirect or other vendors' products, will assure safety for any application. Any person using or applying any products sold by AutomationDirect is responsible for learning the safety requirements for their individual application and applying them, and therefore assumes all risks, and accepts full and complete responsibility, for the selection and suitability of the product for their respective application. AutomationDirect does not provide design or consulting services, and cannot advise whether any specific application or use of our products would ensure compliance with the safety requirements for any application.