

# WC14 NEMA 12 and 13 Operator Consoles



## Construction



## Applications

Designed to hold electrical and electronic controls and instruments. Pushbuttons, pilot lights, meters, switches, etc., can be mounted on the instrument panel. Interior components are mounted on stationary sub panels, swing-out sub panels or relay rack angles (panels are optional). Heavy duty construction provides protection from dirt, dust, oil and water.

### Base

- Bodies and doors fabricated from 14 gauge steel
- Seams are continuously welded and ground smooth, less knockouts or holes
- 3-point keylocking handle is provided on front main door
- Double overlapping doors are provided on two door consoles
- Main hinged doors are flush
- One or two large sloping control panels are hinged on bottom
- Control panels have captivated screws threaded into sealed wells
- Door stops provided to hold control panel open
- Closed cell neoprene gasket
- Horizontal channels are welded to sides of console to support optional panels and swing-out panels
- Grounding provisions provided
- Half, full and swing panels are optional
- An inclined body rail is welded to each side of 24" wide and 36" wide consoles for support of terminal straps
- Optional angle brackets, part number WC14R, are available for mounting 19in rack equipment in the WC14B console.

### Top

- Fabricated from 14 gauge steel
- Top unit is 12.5" deep to accommodate most instruments
- Four holes are provided for mounting to body
- Seams are continuously welded and ground smooth, less knockouts or hole
- Instrument and access panels have captivated screws which thread into sealed wells
- Closed cell neoprene gasket
- Instrument panels and access panels are removable

### Writing desk

- Fabricated from 14 gauge steel
- Seams are continuously welded and ground smooth
- Desks are removable and attach easily to console front

### Finish

- ANSI 61 gray polyester powder inside and out over phosphatized surfaces
- Optional panels are white polyester powder over phosphatized surfaces

### Listings

- UL 508, Types 12 & 13 [UL File E64791]
- CSA Certified, Types 12 & 13 [CSA File LL66078]
- NEMA/EEMAC Types 12 & 13

Enclosure Shipping Schedule		
Same day	1 - 7 days	1 -10 days
Color indicates shipping lead time in business days		



WC14 NEMA 12 and 13 Operator Consoles									
Console Base	Price	Console Base Size HxWxD	Console Top	Price	Writing Desk	Price	Subpanels	Clamping Nuts	Caster Kit
<b>WC14B</b> <i>(Single Door)</i>	\$1,884.00	50.13 x 24.12 x 23.12 [1273 x 613 x 587]	<b>WC14T</b>	\$438.00	<b>WC14W</b>	\$138.00	<b>WC14P1 (Swing Panel)</b>	<b>WAPS1420CN</b>	<b>WC12C</b>
							<b>WC14P2 (Half Panel)</b>		
							<b>WC14P3 (Full Panel)</b>		
<b>WC1436B</b> <i>(Single Door)</i>	\$2,202.00	50.13 x 36.12 x 23.12 [1273 x 917 x 587]	<b>WC1436T</b>	\$543.00	<b>WC1436W</b>	\$177.00	<b>WC1436P1 (Swing Panel)</b>	<b>WAPS1420CN</b>	
							<b>WC1436P2 (Half Panel)</b>		
							<b>WC1436P3 (Full Panel)</b>		
<b>WC1448BD</b> <i>(Double Door)</i>	\$2,655.00	50.13 x 48.12 x 23.12 [1273 x 1222 x 587]	<b>WC1448T</b>	\$648.00	<b>WC1448W</b>	\$217.00	<b>WC1448P2 (Half Panel)</b>	<b>WAPS1420CN</b>	
							<b>WC1448P3 (Full Panel)</b>	<b>WAPS3816CN</b>	
<b>WC1460BD</b> <i>(Double Door)</i>	\$2,933.00	50.13 x 60.12 x 23.12 [1273 x 1527 x 587]	<b>WC1460T</b>	\$753.00	<b>WC1460W</b>	\$256.00	<b>WC1460P2 (Half Panel)</b>	<b>WAPS1420CN</b>	
							<b>WC1460P3 (Full Panel)</b>	<b>WAPS3816CN</b>	

Notes: Dimensions in inches [millimeters]. Letters in table correspond to letters on dimensional drawings. Subpanels, etc. must be ordered separately.

# WC14 NEMA 12 and 13 Operator Consoles

## Dimensions

In [mm]

WC14B

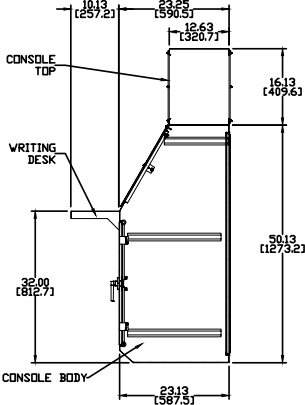
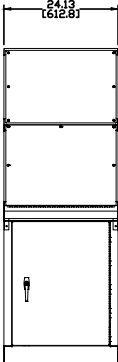

WC1448BD

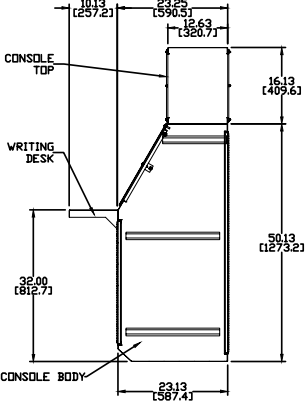
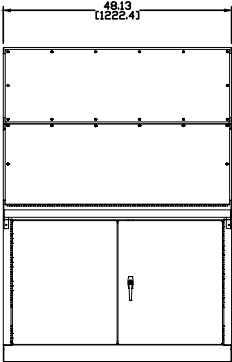

WC1460BD

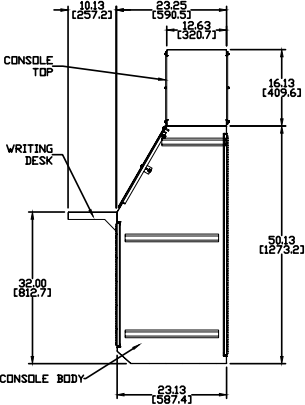
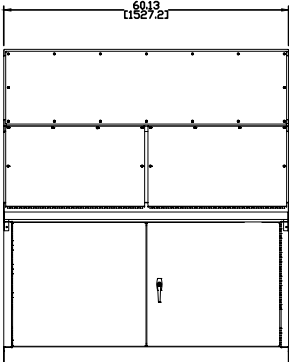

- NOTES:
1. ACCESS DOORS OPEN 180 DEGREES.
  2. 3-POINT KEY LOCKING HANDLES ARE PROVIDED ON MAIN DOORS
  3. WRITING DESK IS PROVIDED WITH MOUNTING HARDWARE.
  4. 48" WIDE CONSOLE HAS TWO DOORS.

See our website: [www.AutomationDirect.com](http://www.AutomationDirect.com) for complete engineering drawings.

# Accessory Panels For WC14 Series Operator Consoles



## Description

- Panels for WC14 Series operator consoles
- Full-height and half-height swing-out panels are available
- Half-height panels can be located in the upper or lower portion of enclosure
- Painted steel subpanels are white polyester powder over phosphatized surfaces
- Fabricated from 14 gauge steel
- Mounting hardware is furnished with each panel



Enclosure Shipping Schedule	
1 - 7 days	1 - 10 days
Color indicates shipping lead time in business days.	

Accessory Panels for WC14 Operator Consoles			
Part Number	Price	Panel Size HxWxD	Subpanel Type
WC14P1	\$189.00	22.00 x 19.75 x 2.69 [559 x 502 x 68]	Swing
WC14P2	\$155.00	22.00 x 17.00 x 0.813 [559 x 432 x 21]	Half
WC14P3	\$223.00	42.25 x 17.00 x 0.81 [1073 x 432 x 21]	Full
WC1436P1	\$237.00	22.00 x 31.69 x 2.75 [559 x 805 x 70]	Swing
WC1436P2	\$191.00	22.00 x 29 x 0.81 [559 x 737 x 21]	Half
WC1436P3	\$293.00	42.25 x 29.00 x 0.81 [1073 x 737 x 21]	Full
WC1448P2	\$227.00	22.00 x 41.00 x 0.81 [559 x 1041 x 21]	Half
WC1448P3	\$362.00	42.25 x 41.00 x 0.81 [1073 x 1041 x 21]	Full
WC1460P2	\$264.00	22.00 x 53.00 x 0.81 [559 x 1346 x 21]	Half
WC1460P3	\$432.00	42.25 x 53.00 x 0.81 [1073 x 1346 x 21]	Full

*Letters in table correspond to letters on dimensional drawings.*

## Dimensions

in [mm]

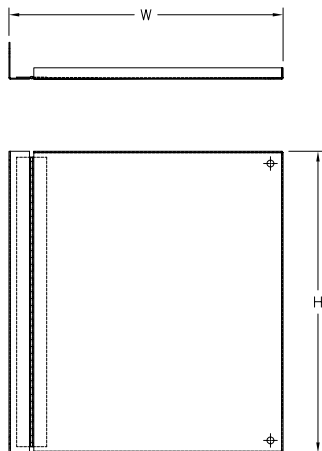

Swing-Out Subpanel

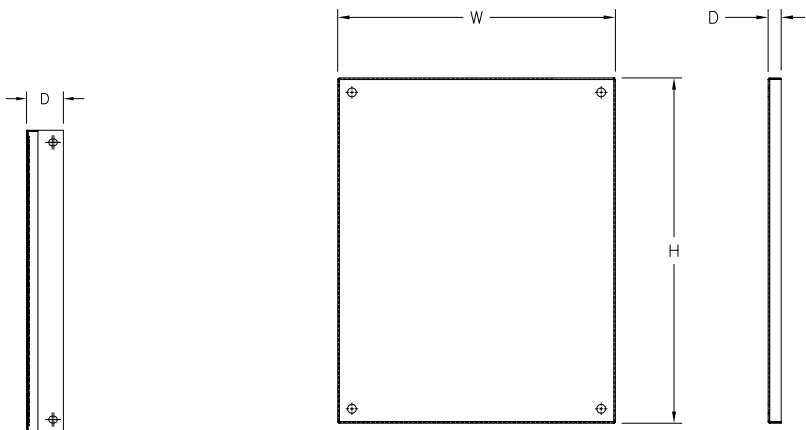

Full or Half Subpanel

See our website: [www.AutomationDirect.com](http://www.AutomationDirect.com) for complete engineering drawings.

# Enclosure Accessories - Mounting Feet and Casters



## Mounting Feet for Premier, Slim Line, Classic, and In-Line Series Enclosures

Mounting Foot Kit	Price	Description	Wt. [oz]
<b>HW-MGFTKIT</b>	\$13.50	Hubbell-Wiegmann mounting feet kit, fiberglass-reinforced polyester, for use on Premier series non-metallic enclosures. Includes (4) mounting feet and mounting hardware.	1
<b>HW-N4XMTGFTKIT</b>	\$25.50	Hubbell-Wiegmann mounting feet kit, fiberglass-reinforced polyester, for use on Slim Line and In-line series non-metallic enclosures. Includes (2) mounting feet, mounting hardware and silicone adhesive/sealant. (Fits 4-inch wide HW-N4Xxxx, HW-N4XxPB and HW-N4XxPB-22 series enclosures only.)	1
<b>HW-LMTGFTKIT</b>	\$25.508.00	Hubbell-Wiegmann mounting feet kit, fiberglass-reinforced polyester, for use on Classic series non-metallic enclosures. Includes (4) mounting feet and mounting hardware.	1

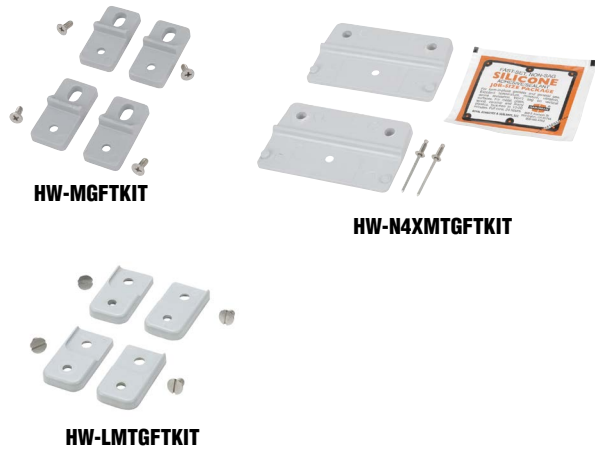

## Mounting Feet for Ultimate Series Enclosures

Mounting Feet	Price	Description	Wt. [lb]
<b>N412MFK</b>	\$17.25	Hubbell-Wiegmann mounting feet kit, plated finish. For use on NEMA 412 Ultimate series enclosures. Includes (4) mounting feet, mounting hardware and sealing washers.	4
<b>N412MFKSS</b>	\$48.00	Hubbell-Wiegmann mounting feet kit, 304 stainless steel. For use on NEMA 412 Ultimate series enclosures. Includes (4) mounting feet, mounting hardware and sealing washers.	4

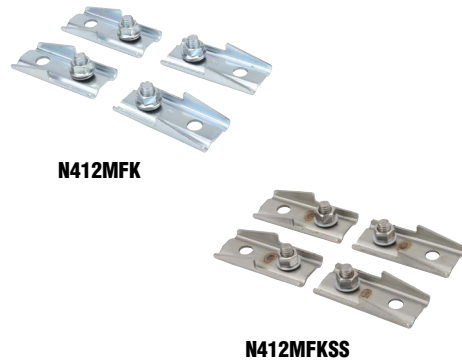

## Casters

Casters can be used on any enclosure to provide mobility. Caster kits include mounting plates designed to fit Hubbell-Wiegmann WC10 and WC12 consoles, but can be adapted to fit other enclosures.

Caster Kit	Price	Description	Wt. [lb]	Capacity [lb]
<b>WC10C</b>	\$173.00	Hubbell-Wiegmann caster kit, for WC10 consoles. Includes 4 zinc-plated steel casters (2 swivel, 2 stationary), 2 ANSI 61 gray mounting plates and hardware.	4	200
<b>WC12C</b>	\$173.00	Hubbell-Wiegmann caster kit, for WC12 consoles. Includes 4 zinc-plated steel casters (2 swivel, 2 stationary), 2 ANSI 61 gray mounting plates and hardware.	4	200



Enclosure Shipping Schedule		
Same day	1 - 7 days	1-10 days
Color indicates shipping lead time in business days.		

# Enclosure Accessories - Fasteners and Miscellaneous



## Print pockets



**WAPPL0810**

Print Pockets	Price	Description	Wt. [lb]
<b>WAPPL0606</b>	\$12.50	6"x6" plastic print pocket can be placed anywhere within enclosure using 2-way adhesive tape flanges. Color: white	0.5
<b>WAPPL0810</b>	\$20.50	8"x10" plastic print pocket can be placed anywhere within enclosure using 2-way adhesive tape flanges. Color: white	

## Stainless Steel Screws



**HW-2PKSS**

Stainless Steel Screws	Price	Description	Wt. [oz]
<b>HW-2PKSS</b>	\$1.75	Stainless steel screws #10-24 x 5/8in long, with o-rings- pkg of 2	1
<b>HW-4PKSS</b>	\$3.50	Stainless steel screws #10-24 x 5/8in long, with o-rings - pkg of 4	

## Encapsulated Screws



**HW-2PKENCAP**

Encapsulated Screws	Price	Description	Wt. [oz]
<b>HW-2PKENCAP</b>	\$1.75	PVC-encapsulated screws - pkg of 2	1
<b>HW-4PKENCAP</b>	\$3.50	PVC-encapsulated screws - pkg of 4	

## Clamp Nuts



Clamp nuts for enclosure unistrut are available for special purposes and spares, but are not required for standard enclosure accessories.

Clamp Nuts	Price	Description	Wt. [lb]
<b>WAPS1420CN</b>	\$17.50	1/4-20 clamp nut with 1/4-20 x 1/2in-long pan head screw. Package of 2.	1
<b>WAPS3816CN</b>	\$16.50	3/8-16 clamp nut with 3/8-16 x 1in-long hex bolt. Package of 1.	

## Spring Nut

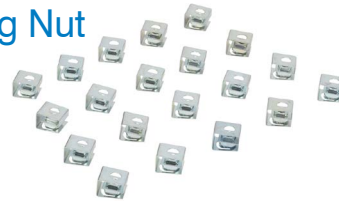

Spring Nut Package	Price	Description	Wt. [lb]
<b>HFWSHC</b>	\$16.00	Grid fasteners for mounting equipment to grid straps. Package of 20 spring nuts with 1/4-20 pan head screws.	0.1
<b>W1032N</b>	\$30.00	Plated #10-32 spring nuts will fit all rack mounting angles with 7/32 diameter holes. Package of 20.	

## Touch-up paint



**WAGSE**

Touch-Up Paint	Price	Description	Wt. [lb]
<b>WAGSE</b>	\$17.50	ANSI-61 gray satin enamel in 12 oz. spray can. Use on existing enclosure and subpanel finishes.	1.5

## Enclosure Shipping Schedule

Same day	1-10 days
Color indicates shipping lead time in business days.	