



Multi-Wire Connectors

Features

- Available in 3A, 10A, 16A, 6B, 10B, 16B, and 24B sizes
- Heavy-duty metal housings in polyester powder-coated die-cast aluminum alloy or self-extinguishing thermoplastic housing
- Single locking system (one lever locked on two pegs) or double locking system (two levers locked on four pegs)
- Mechanical duration of 500 cycles
- Operating temperatures from -40 to 125°C [-40 to 257°F]
- IP65 degree of protection with enclosure when coupled
- Conforms with EN61984, VDE 0110, VDE 0627, and UL 1977 standards
- UL and CE approvals

Housings

Hoods

- Available with top entry and side entry cable passages
- Standard profiles
- Threaded cable passages with NPT threads
- Stainless steel or thermoplastic locking pegs

Bases, Couplers, and Covers

- Surface- and bulkhead-mounted bases
- Seal gaskets made of anti-aging, oil-resistant and fuel-resistant vinyl nitrile elastomer
- Locking levers made of galvanized steel or self-extinguishing glass-filled thermoplastic; guarantees perfect closing and sealing

Inserts

- Self-extinguishing thermoplastic reinforced with glass fibers
- Asymmetric guide rails prevent incorrect coupling
- Captive installation screws allow for easy and secure installation to bases and hoods
- Laser-printed or molded terminal/contact positions on both sides of insert
- Copper alloy contacts with hard silver plating - available with stainless steel captive screw terminal or machined crimp contact
- Wide contact surface for ground terminals
- IP20 without enclosures
- Suitable for stranded and solid conductors

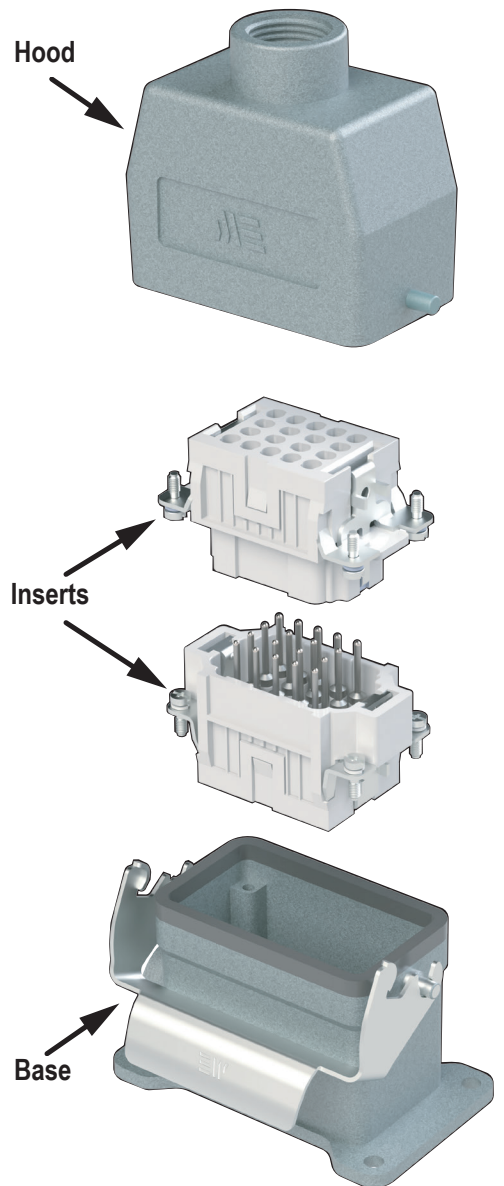

Agency Approvals

- UL Recognized File number E307105
- CE



To obtain the most current agency approval information, see the Agency Compliance & Certifications Checklist section on the specific part number's web page.

General Characteristics

Application Examples

- Electronic machinery
- Robots
- Control equipment
- Power connections
- Control and signal circuits
- Packaging machinery
- Theatrical applications
- Industrial equipment
- Electrical panels

Inserts

METEcon multi-wire connectors require one male and one female insert. The inserts are available in multiple pole configurations from 2-poles plus ground up to 108-poles plus ground and with termination sizes ranging from 26 to 12 AWG, 10 to 80 Amps.

METEcon inserts are made of UL 94 V-0 rated self-extinguishing thermoplastic resin rated at a maximum temperature of 125°C (257°F). The inserts are available in screw terminal and crimp-style contact block connections. The contacts are copper alloy with a hard silver-plated alloy. The plastic insulators are numbered on both sides by laser printing or molding in accordance with EN 60068-2-70.

- Suitable for use with alternating current (AC) or direct current (DC)
- Leading protective ground
- Polarized for correct mating
- Interchangeable for male and female inserts in hoods and bases
- Captive screws
- Exception: 3A has housing/hood specifically for female or for male.

Housings

The housings for the METEcon multi-wire connectors consist of a hood that mates with a base or a coupler.

They are made of die-cast aluminum with a polyester powder finish or from self-extinguishing thermoplastic and are suitable for use in industrial applications.

A single- or double-lever locking system assures coupling stability and protection against accidental opening. The locking system is comprised of stainless steel or glass-filled thermoplastic levers, with compatible interlocking pegs.

Size and Identification

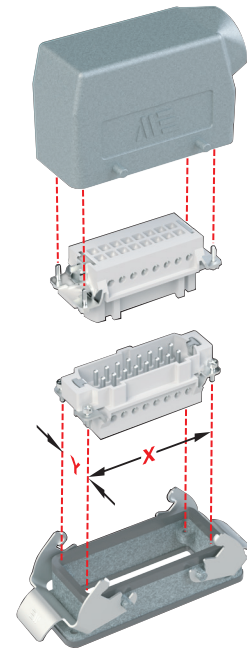

Size 16B

The size of each type of connector is determined by the distance between the center points of the four installation screws. These four points are common to both the insert and the housing. This is indicated by "X"- "Y" in the illustration above.

The table below lists the size identification and the actual X-Y distance for each type of connector offered.

Size	Distance X-Y
3A	21 x 21mm* [0.83 x 0.83in]
10A	49.5 x 16mm [1.95 x 0.63in]
16A	66 x 16mm [2.60 x 0.63in]
6B	44 x 27mm [1.73 x 1.06in]
10B	57 x 27mm [2.24 x 1.06in]
16B	77.5 x 27mm [3.05 x 1.06in]
24B	104 x 27mm [4.09 x 1.06in]

* The center distance cannot be given because the 3A inserts have only one screw: 21 x 21 indicates the size of the sectioned insert.

Conductor Termination

Overview

Two types of conductor termination are available for METEcon inserts:

- Screw terminations
- Crimp terminations

Screw Terminations

Screw terminations consist of contacts made of silver-plated copper alloy and are incorporated with a wire clamp (with the exception of the size 3A inserts and size 24B with 80A contacts) for firmly securing the conductors. The screw terminals use stainless steel captive screws and meet VDE 0609 / EN 60999 standards.

Proper conductor installation requires no special preparation when using inserts with the wire clamp terminals (no wire ferrules). The table below lists the current rating, maximum wire gauge, and stripping lengths.

Current Rating	Max Wire Gauge		Stripping Length mm [n]
	mm ²	AWG	
10A	2.5	14	7 [0.28]
16A	2.5	14	7 [0.28]
35A	6.0	10	7 [0.28]
16/80A	2.5/16	14/6	7.5 [0.3] / 14 [0.55]

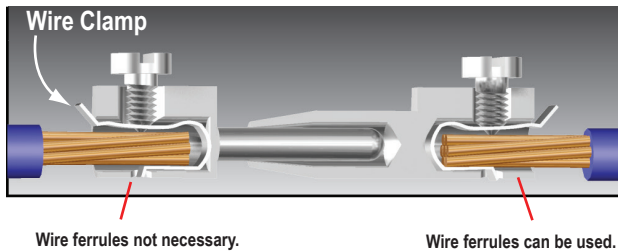

Screw Terminals with Clamps

The value of tensile strength of conductors in accordance with the dimensions of the screws and the wires are shown in the following table:

Wire Gauge mm ² [AWG]	1.5 [16]	2.5 [14]	4 [12]	6 [10]	10 [8]	16 [6]
Size of Screw	M3	M3	M3.5	M4	M4	M6
Tensile Strength of Stranded Wire (N)	40	50	60	80	90	100

Increasing the tightening torque does not necessarily improve the contact resistance. The screw torques are selected according to standard EN 60999-1, to provide excellent mechanical, thermal, and electrical behavior. The conductor or terminal may be damaged if the recommended values are significantly exceeded.

Insert Screw Specifications

Insert Size	Screw Type	Screw Size	Tightening Torque N·m [in·lb]	Recommended Screwdriver Size	Recommended Screwdriver Part Number
3A	10 Amp Terminal	M3	0.50 [4.4]	0.4 x 2.5	TW-SD-VSL-2
	Installation	M3			
	Ground	M3.5			
10A, 16A	16 Amp Terminal	M3	0.50 [4.4]	0.5 x 3.0	TW-SD-SL-1
	Installation	M3			
	Ground	M4			
6B, 10B	16 Amp Terminal	M3	0.50 [4.4]	Ph 0 - 0.8 x 4	TW-SD-VSL-3
	Installation	M3			
	Ground	M4		1.2 [10.6]	Ph 2 1.0 x 5.5
16B	35 Amp Terminal	M4	0.50 [4.4]	Ph 1 - 0.8 x 4	TW-SD-VSL-3
	16 Amp Terminal	M3			
	Installation	M3			
	Ground	M4		1.2 [10.6]	Ph 2 1.0 x 5.5
24B	80 Amp Terminal	M6	1.5 mm ² [16 AWG] 1.2 [10.6]	1.0 x 5.5	TW-SD-VSL-4
			2.5 mm ² [14 AWG] 2 [17.7]		
			4-16 mm ² [12-6 AWG] 3 [26.6]		
	16 Amp Terminal	M3	0.50 [4.4]	Ph 0 - 0.8 x 4	TW-SD-VSL-3
	Installation	M3			
Ground	M4	1.2 [10.6]	Ph 2 1.0 x 5.5	TW-SD-VSL-4	

Crimp Terminations

Crimp terminations consist of contacts made of silver-plated copper alloy. Crimp terminations are accomplished by applying a crimp contact to the conductor by means of a crimping tool. Crimp contacts are available in several sizes:

10 amp, 26-14 AWG ; 16 amp, 26-12 AWG

A perfect crimp connection is gas-tight, corrosion-free, and is equal to a cold weld of the parts being connected. Wires to be connected must be carefully matched with the correct wire size of crimp contacts.

The requirements for crimp connectors are depicted in IEC 60352, part 2.

Note: Low currents and voltages:

METEcon standard contacts (screw and crimp) have a silver-plated surface. This metal has excellent conductive properties. During the contact's lifetime, the silver surface generates a black oxide layer due to its affinity to sulphur (always present in the atmosphere). This layer is conductive smooth and very thin and is partly interrupted when the contacts are mated and non mated, thus guaranteeing very low contact resistances. In the case of very low current or voltage, small changes to the transmitted signal may be encountered.

Crimp Contact to Insert Installation

Proper installation of the crimp contacts is important for a good electrical and mechanical connection. The following steps will ensure correct installation.

Step 1: Select the Crimp Contacts

Select a crimp contact based on the rating of the Insert you are using; 10 or 16 amps; the gender (male or female), and the gauge of wire being used.

Step 2:

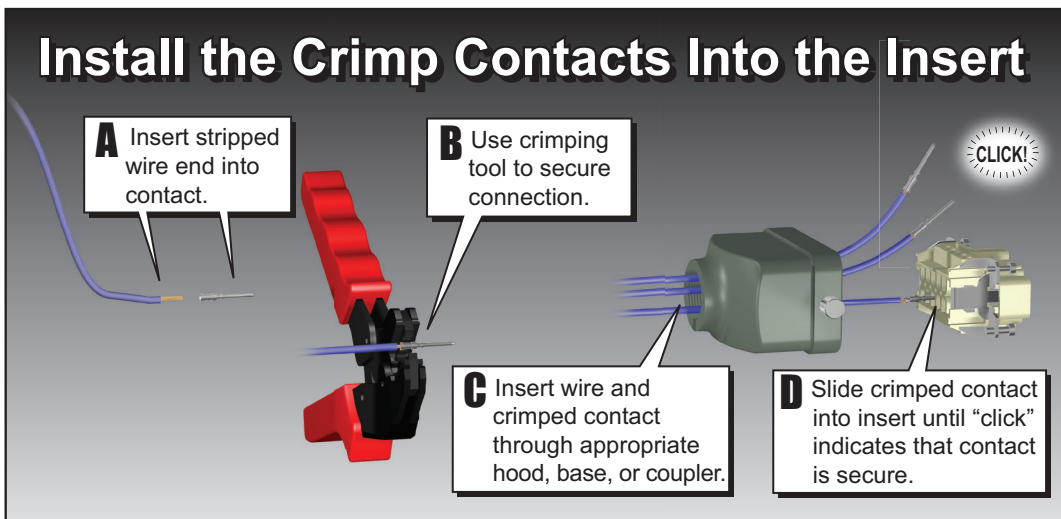

Step 3: Install the Insert into the Housing

Now that the crimp contacts are installed, the Insert can be placed into the housing by aligning the corner installation screws of the insert with the screw holes located in the corners of the housing. Tighten the screws according to the tightening torques listed in the Insert Screw Specifications table in this document.

Wire Entry Connection

METEcon openings for easy conduit and cable terminations. The openings come in NPT threaded sizes 3/8", 1/2", or 3/4".

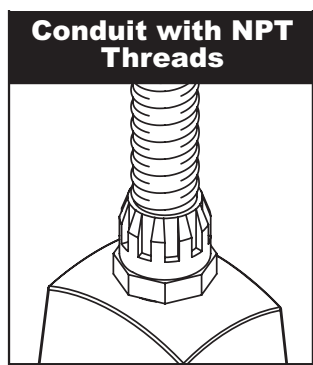

Secures NPT threaded flexible conduit directly to the housing.

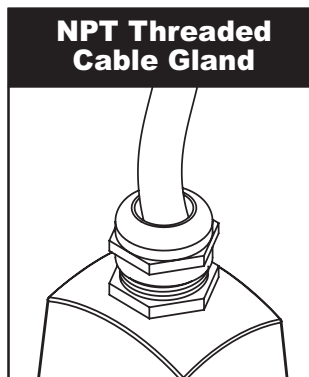

For securing a cable to the housing, use an NPT threaded cable gland.



Multi-Wire Connectors

Standards

The Inserts are designed and manufactured to conform with EN 61984, (IEC 61984), VDE 0627, and UL 1977/CSA C22.2 182.3 standards. They are certified and labeled with the cULus and CE marks. The connectors are therefore in conformance with both European/International and American systems. This permits them to be used in a wider range of applications worldwide.

• EN 61984	Connectors safety requirements and tests
• VDE 0627	Connectors (DIN VDE 0627)
• EN 60664-1	Insulation coordination for equipment within low-voltage systems
• VDE 0110	Table 4 concerning clearance and creepage distances
• EN 60512	Connectors for electronic equipment, tests, and measurements
• UL 1977	Component connectors for use in data, signal, control, and power applications
• CSA.C22.2 No. 182.3	Special use attachment, plugs, receptacles, and connectors
• EN 60529	Degree of protection provided by enclosures (IP degree)
• EN 60423	Conduits for electrical purposes. Outside diameters of conduits for electrical installations and thread for conduits and fittings

Directives and Declarations

LVD Directive

Directive 2006/95/EC of the European Parliament and of the council of 12 December 2006 on the harmonization of the laws of Members States relating to electrical equipment designed for use within certain voltage limits.

RoHS Directive

Directive 2011/65/EU and amendment (EU) 2015/863 restricts the use of the following ten substances:

Lead (Pb)

Mercury (Hg)

Cadmium (Cd)

Hexavalent chromium (Cr6+)

Polybrominated biphenyls (PBB)

Polybrominated diphenyl ether (PBDE)

Bis(2-ethylhexyl) phthalate (DEHP)

Butyl benzyl phthalate (BBP)

Regulation (EC) No 1907/2006 of the European Parliament and of the Council of 18 December 2006 concerning the Registration Evaluation, Authorization and Restriction of Chemicals (REACH), establishing a European Chemicals Agency, amending Directive 1999/45/EC and repealing Council Regulation (EEC) No 793/93 and Commission Regulation (EC) No 1488/94 as well as Council Directive 76/769/EEC and Commission Directives 91/155/EEC, 93/67/EEC, 93/105/EEC and 2000/21/EC.



WARNING - ACCORDING TO EN 61984, CONNECTORS SHOULD NOT BE COUPLED AND DECOUPLED UNDER ELECTRICAL LOAD.





Multi-Wire Connectors

Screw Terminal Basic Assembly

Crimp Contact Basic Assembly

Housing
(Size 16B Hood)



Strain Relief
(Cable Gland
Optional)

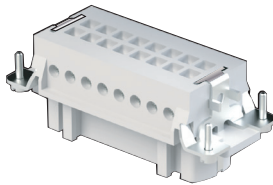

Female Insert
(Screw Type)

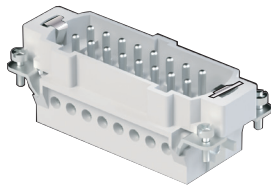

Male Insert
(Screw Type)

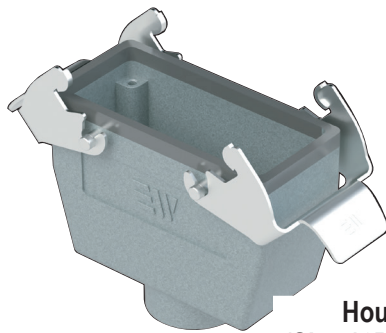

Housing
(Size 16B Coupler)



Strain Relief
(Cable Gland
Optional)



Strain Relief
(Cable Gland
Optional)

Housing
(Size 10B Hood)

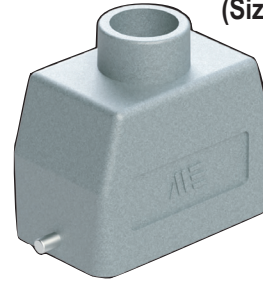

Crimp Contacts
(Female Contact)

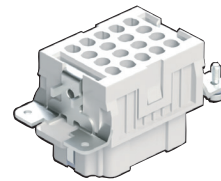

Female Insert
(Crimp Type)

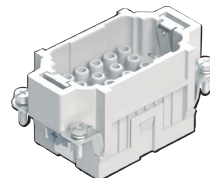

Male Insert
(Crimp Type)



Crimp Contacts
(Male Contact)

Strain Relief
(Cable Gland
Optional)

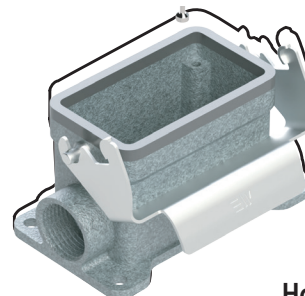

Housing
(Size 10B Surface
Mount)



Multi-Wire Connectors Specifications

Technical Characteristics													
Connector Size		6B			10B			16B					
Inserts	Number of Poles		6+PE	10+PE	24+PE	10+PE	18+PE	42+PE	6+PE	16+PE	32+PE	40+PE	72+PE
	UL/CSA Rated Voltage*		600 VAC/VDC										
	Maximum Rated Current		16A	10A		16A	10A		35A	16A		10A	
	EN 61984 (2001-11) Pollution Degree 3	Rated Voltage AC/DC		500V	250V		500V	250V		400/690V	500V		250V
		Impulse Withstand Voltage		6kV	4kV		6kV	4kV		6kV			4kV
	Continuous Current Carrying Capacity		Refer to Electrical Engineering section charts										
	Insulation Resistance		$\geq 10^{10} \Omega$										
	Material		PBT	Polycarbonate		PBT	Polycarbonate		PBT		Polycarbonate		
	Temperature Range		-40 to 125°C [-40 to 257°F]										
	Flammability		UL 94 V-0										
	Degree Protection	With Housing		IP65									
		Without Housing		IP20									
	Mechanical Working Life		500 Cycles										
Conductor Termination	Screw Terminals		√	N/A	N/A	√	N/A	N/A	√	√	N/A	N/A	N/A
	Crimp Contacts		N/A	√	√	N/A	√	√	N/A	N/A	√	√	√
Contacts	Material		Hard-silver plated (2μm Au) or gold plated copper alloy										
	Minimum Recommended Load (voltage & current)		5V / 5mA AC/DC										
	Contact Resistance		$\leq 1\text{m}\Omega$		$\leq 3\text{m}\Omega$	$\leq 1\text{m}\Omega$		$\leq 3\text{m}\Omega$	$\leq 1\text{m}\Omega$		$\leq 3\text{m}\Omega$		
	Screw Terminal Wire Size	mm ²	1.0 - 2.5	N/A		1.0 - 2.5	N/A		4.0-6.0	1.0-2.5	N/A		
		AWG	18 - 14	N/A		18 - 14	N/A		12 - 10	18 - 14	N/A		
	Screw Terminal Tightening Test Torque N·m [in·lb]		0.5 [4.4]	N/A		0.5 [4.4]	N/A		1.2 [10.6]	0.5 [4.4]	N/A		
	Screw Terminal Stripping Length (9mm)		7	N/A		7	N/A		7	7	N/A		
	Crimp Terminal Wire Size	mm ²	N/A	0.14 - 1.0	0.14 - 2.5	N/A	0.14 - 1.0	0.14 - 2.5	N/A	N/A	0.14 - 1.0	0.14 - 2.5	
		AWG	N/A	26 - 12	26 - 14	N/A	26 - 12	26 - 14	N/A	N/A	26 - 12	26 - 14	
Crimp Terminal Stripping Length (mm)		N/A	7.5	8	N/A	7.5	8	N/A	N/A	7.5	8		
Aluminum Hoods/Bases/ Couplers/Covers	Material		Die cast aluminum alloy										
	Locking Element		Carbon steel										
	Housings Seal		NBR (Nitrile)										
	Degree of Protection Acc. to EN 60529		IP65										
	Temperature Range		-40 to 125°C [-40 to 257°F]										
	Thread		NPT ASME B1.20.1										

* Connectors should not be coupled and decoupled under electrical load.

Multi-Wire Connectors

Size 16B

**29125****29023****290233032****290233040****290233072****29124****29022****290223032****290223040****290223072**

16B Inserts						
Insert Type	No. of Poles	6+PE	16+PE	32+PE	40+PE	72+PE
	Rated Voltage	600 VAC/VDC	600 VAC/VDC	600 VAC/VDC	600 VAC/VDC	600 VAC/VDC
	Max. Rated Current	35 amp	16 amp	16 amp	10 amp	10 amp
	Termination Type	Screw Terminals	Screw Terminals	Crimp Contacts	Crimp Contacts	Crimp Contacts
Male	Part Number	<u>29125</u>	<u>29023</u>	<u>290233032</u>	<u>290233040</u>	<u>290233072</u>
	Price	\$14.00	\$8.00	\$13.00	\$11.50:	\$17.50:
	Drawing Link	PDF	PDF	PDF	PDF	PDF
	Crimp Contact Size*	N/A	N/A	16 Amp METE 14106xxx series	10 Amp METE 14104xxx series	
	Weight g [oz]	80.74 [2.85]	92.99 [3.28]	58.51 [2.06]	50.35 [1.78]	56.88 [2.01]
Female	Part Number	<u>29124</u>	<u>29022</u>	<u>290223032</u>	<u>290223040</u>	<u>290223072</u>
	Price	\$14.50	\$8.50	\$13.50	\$12.00	\$18.00
	Drawing Link	PDF	PDF	PDF	PDF	PDF
	Crimp Contact Size*	N/A	N/A	16 Amp METE 14105xxx series	10 Amp METE 14103xxx series	
	Weight g [oz]	86.68 [3.06]	99.88 [3.52]	68.63 [2.42]	60.33 [2.13]	61.10 [2.16]

*Crimp contacts must be purchased separately. The XXX represents wire AWG. See Accessories section for complete part numbers.

Multi-Wire Connectors

Size 16B

**293642905****293632905****293612905S****29360S****293662905S****291552905****290432905****290562905S****29042S****291602905S****29651****29654S**

16B Hoods and Housings

Housing Component		Threaded Opening	Part Number	Price	Works With	Weight g [oz]	Drawing Link
Single Lever / 2 Pegs	Hood, Top Entry, (2-Peg), Aluminum	(1) 3/4 NPT threaded hole	<u>293642905</u>	\$10.50	METE size 16B single lever connector housings	167.83 [5.92]	<u>PDF</u>
	Hood, Side Entry, (2-Peg), Aluminum	(1) 3/4 NPT threaded hole	<u>293632905</u>	\$10.00	METE size 16B single lever connector housings	185.93 [6.56]	<u>PDF</u>
	Surface Mount, Side Entry, (Single Lever), Aluminum	(1) 3/4 NPT threaded hole	<u>293612905S</u>	\$18.00	METE size 16B 2-peg connector housings	240.41 [8.48]	<u>PDF</u>
	Bulkhead Base, (Single Lever), Aluminum	N/A	<u>29360S</u>	\$10.00	METE size 16B 2-peg connector housings	124.29 [4.38]	<u>PDF</u>
	Coupler, Top Entry, (Single Lever), Aluminum	(1) 3/4 NPT threaded hole	<u>293662905S</u>	\$16.00	METE size 16B 2-peg connector housings	209.56 [7.39]	<u>PDF</u>
Double Level / 4 Pegs	Hood, 4-Peg, Top Entry, Aluminum	(1) 3/4 NPT threaded hole	<u>291552905</u>	\$10.00	METE size 16B double lever connector housings	164.66 [5.81]	<u>PDF</u>
	Hood, 4-Peg, Side Entry, Aluminum	(1) 3/4 NPT threaded hole	<u>290432905</u>	\$8.00:	METE size 16B double lever connector housings	185.98 [6.56]	<u>PDF</u>
	Surface Mount, Double Lever, Side Entry, Aluminum	(1) 3/4 NPT threaded hole	<u>290562905S</u>	\$15.00:	METE size 16B 4-peg connector housings	249.48 [8.80]	<u>PDF</u>
	Bulkhead Housing, Double Lever, Aluminum	N/A	<u>29042S</u>	\$8.50	METE size 16B 4-peg connector housings	130.64 [4.61]	<u>PDF</u>
	Coupler Housing, Double Lever, Top Entry, Aluminum	(1) 3/4 NPT threaded hole	<u>291602905S</u>	\$16.00	METE size 16B 4-peg connector housings	217.73 [7.68]	<u>PDF</u>
	Cover Housing, 4-Peg, Plastic	N/A	<u>29651</u>	\$2.00	METE size 16B double lever connector housings	18.14 [0.64]	<u>PDF</u>
	Cover Housing, Double Lever, Plastic	N/A	<u>29654S</u>	\$5.50:	METE size 16B 4-peg connector housings	73.94 [2.61]	<u>PDF</u>

Electrical Engineering Data - Load Diagrams

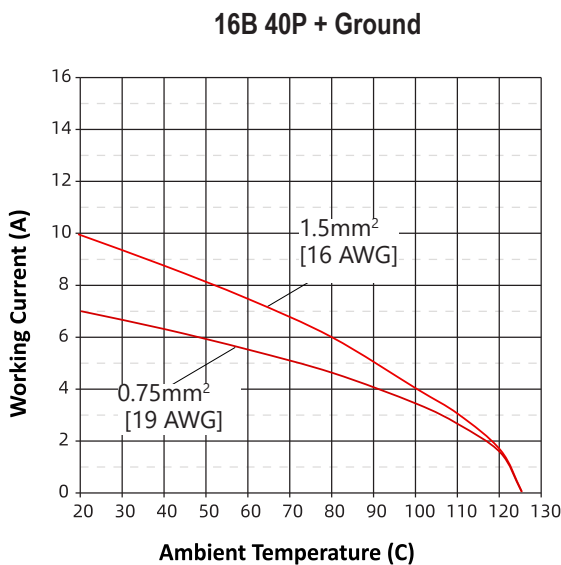
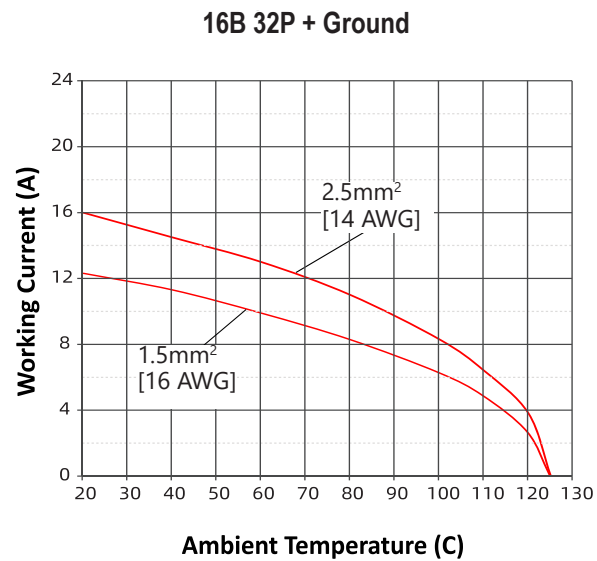
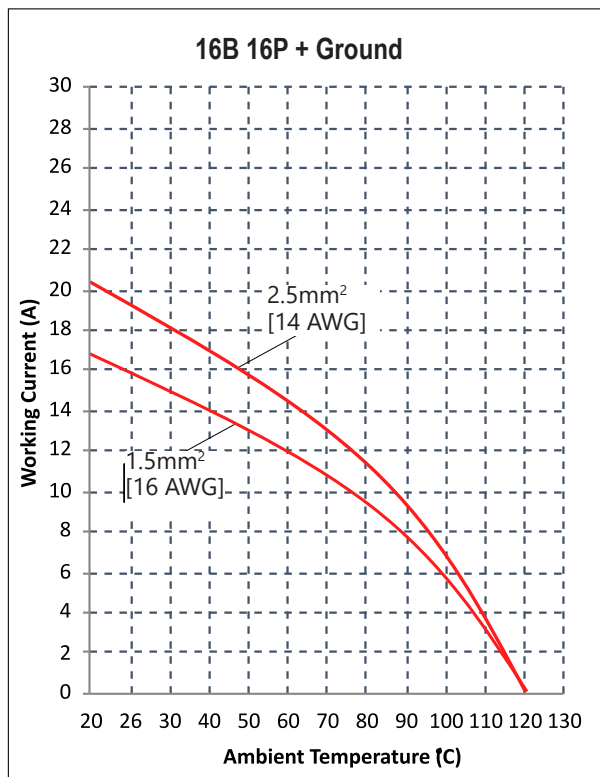
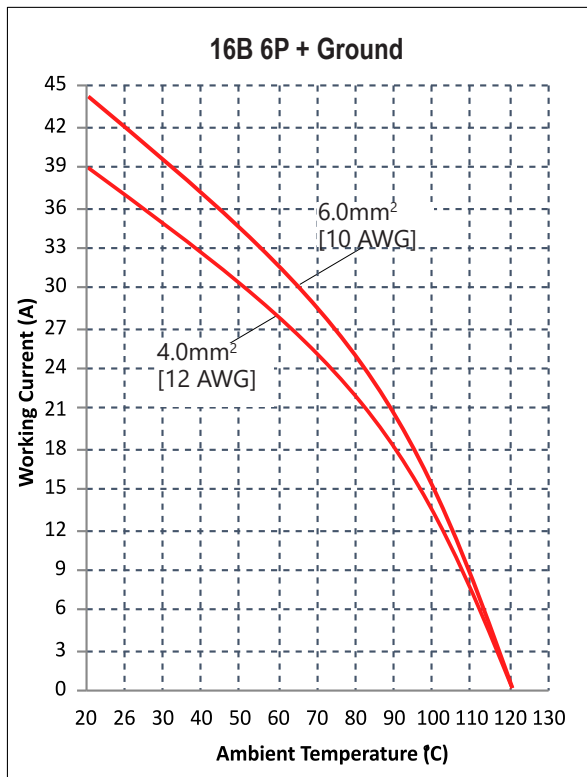



Multi-Wire Connectors

Electrical Engineering Data - Load Diagrams

16B 72P + Ground

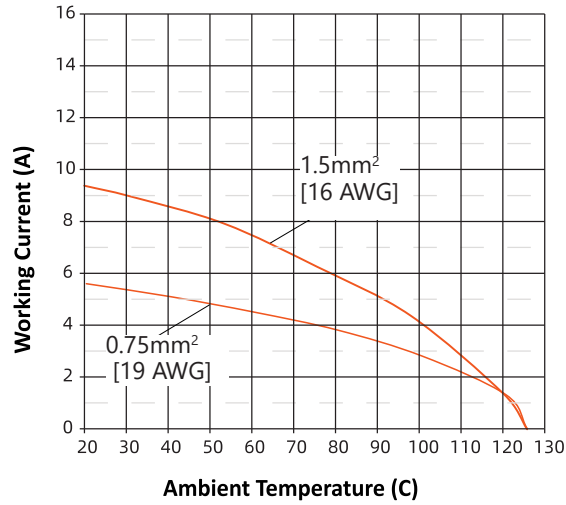



Multi-Wire Connectors Accessories

Crimp Contacts - 10 and 16 Amp

Crimp contacts are made of hard silver-plated alloy. Wires to be connected must be carefully matched with the correct wire size of crimp contacts. Crimp contacts should be installed using a crimping tool.

10 Amp Crimp Contacts - 100/Pack							
Male	Price	Weight g [oz]	Female	Price	Weight g [oz]	Wire Gauge mm ² [AWG]	Stripping Length
14104164	\$40.00	71.67 [2.53]	14103164	\$45.00	68.95 [2.43]	0.14-0.37 [26-22]	8mm [0.31in]
14104264	\$40.00	70.31 [2.48]	14103264	\$45.00	68.49 [2.42]	0.5 [20]	
14104364	\$40.00	67.59 [2.38]	14103364	\$45.00	67.13 [2.37]	0.75 [18]	
14104564	\$40.00	66.23 [2.34]	14103564	\$45.00	66.68 [2.35]	1.5 [16]	
14104664	\$40.00	61.60 [2.17]	14103664	\$45.00	62.60 [2.21]	2.5 [14]	



Male Crimp Contact



Female Crimp Contact



Male Crimp Contact



Female Crimp Contact

16 Amp Crimp Contacts - 100/Pack							
Male	Price	Weight g [oz]	Female	Price	Weight g [oz]	Wire Gauge mm ² [AWG]	Stripping Length
14106164	\$35.50	120.43 [4.25]	14105164	\$40.00	156.95 [5.54]	0.14-0.37 [26-22]	7.5mm [0.29in]
14106264	\$35.50	135.17 [4.77]	14105264	\$40.00	162.84 [5.74]	0.5 [20]	
14106364	\$35.50	131.09 [4.62]	14105364	\$40.00	146.51 [5.17]	0.75 [18]	
14106564	\$35.50	131.32 [4.63]	14105564	\$40.00	152.86 [5.39]	1.5 [16]	
14106664	\$35.50	139.71 [4.93]	14105664	\$40.00	166.47 [5.87]	2.5 [14]	
14106864	\$35.50	136.53 [4.82]	14105864	\$40.00	154.68 [5.46]	4.0 [12]	

Crimp Contact Tools				
Part Number	Price	Qty	Description	Weight [lb]
ZP-MC-CT1	\$775.00	1	Crimping tool w/die set and locator	1.593
ZP-MC-CT2	\$112.00		Crimping tool w/die set only, no locator	0.814
ZP-MC-RT1	\$116.00		Removal tool for 10A contacts	0.081
ZP-MC-RT2	\$105.00		Removal tool for 16A contacts	0.086



[ZP-MC-CT1](#)



[ZP-MC-CT2](#)



[ZP-MC-RT1](#)



[ZP-MC-RT2](#)