

IP69K-rated M8 Sensor Cables

Cables with quick-disconnect plugs

- Industry standard axial and right-angle M8 connectors with open leads
- Available in 2m, 5m, and 10m cable lengths
- PVC (polyvinyl chloride) jacket for food and beverage industrial applications
- IP69K rating, suitable for food and beverage industrial applications
- 316L stainless steel coupling nut
- EPDM O-ring



M8 Quick-Disconnect Cables						
Part Number	Price	Length m (ft)	Poles	Connector	Jacket	Dimensions
EVT421	\$10.50	2 (6.56)	4	Axial female	Orange PVC	Figure 1
EVT422	\$13.50	5 (16.4)	4	Axial female	Orange PVC	Figure 1
EVT423	\$18.50	10 (32.81)	4	Axial female	Orange PVC	Figure 1
EVT424	\$10.50	2 (6.56)	4	Right-angle, female	Orange PVC	Figure 2
EVT425	\$13.50	5 (16.4)	4	Right-angle, female	Orange PVC	Figure 2
EVT426	\$18.50	10 (32.81)	4	Right-angle, female	Orange PVC	Figure 2

Patch cables with quick-disconnect plugs on each end

- Industry standard M8 screw-lock connectors
- One male and one female connector
- Axial and right-angle connector models
- 0.6 m, 1m, 2m, and 5m cable lengths
- PVC (polyvinyl chloride) jacket for food and beverage industrial applications
- IP69K rating, suitable for food and beverage industrial applications
- 316L stainless steel coupling nut
- EPDM O-ring



M8 Patch Cables with Quick-Disconnect on Each End (Euro, Micro DC-Single Key)						
Part Number	Price	Length m (ft)	Poles	Connectors	Jacket	Dimensions
EVT428	\$15.50	0.6 (1.97)	4	Axial female to axial male	Orange PVC	Figure 3
EVT429	\$16.50	1 (3.28)	4	Axial female to axial male	Orange PVC	Figure 3
EVT430	\$20.50	2 (6.56)	4	Axial female to axial male	Orange PVC	Figure 3
EVT431	\$23.50	5 (16.4)	4	Axial female to axial male	Orange PVC	Figure 3
EVT433	\$15.50	0.6 (1.97)	4	Axial male to right angle female	Orange PVC	Figure 4
EVT434	\$16.50	1 (3.28)	4	Axial male to right angle female	Orange PVC	Figure 4
EVT435	\$20.50	2 (6.56)	4	Axial male to right angle female	Orange PVC	Figure 4
EVT436	\$23.50	5 (16.4)	4	Axial male to right angle female	Orange PVC	Figure 4

IP69K-rated M8 Sensor Cables

Cable Specifications	
Specification	M8
Nominal Voltage	50VAC / 60VDC
Max Current	3A
Protection Degree	IEC IP65 / IP67 / IP68 / IP69K
Material Nut	316L stainless steel
Jacket Material	Polyvinyl chloride (PVC)
Housing Material	Polyvinyl chloride (PVC)
Contacts Material	Gold plated
Tightening Torque	0.3 to 0.5 N·m
Conductors Cross Section (AWG)	22AWG
Ø Outer Cable	4.9 mm
Temperature Range	-25° to 80°C (-13° to 176°F)
Environmental	Silicone free
Bending Radius	Min. 10 x cable diameter
Agency Approvals	UL E191684

UL Reference	
Part Number	UL Catalog Number
EVT421	ADOGF040VAS0002E04
EVT422	ADOGF040VAS0005E04
EVT423	ADOGF040VAS0010E04
EVT424	ADOAF040VAS0002E04
EVT425	ADOAF040VAS0005E04
EVT426	ADOAF040VAS0010E04
EVT428	VDOGF040VAS00.6E04STGF040VAS
EVT429	VDOGF040VAS0001E04STGF040VAS
EVT430	VDOGF040VAS0002E04STGF040VAS
EVT431	VDOGF040VAS0005E04STGF040VAS
EVT433	VDOAF040VAS00.6E04STGF040VAS
EVT434	VDOAF040VAS0001E04STGF040VAS
EVT435	VDOAF040VAS0002E04STGF040VAS
EVT436	VDOAF040VAS0005E04STGF040VAS

Note: To obtain the most current agency approval information, see the Agency Approval Checklist section on the specific part number's web page.

M8 Cables Mounting Instructions

Socket Appearance

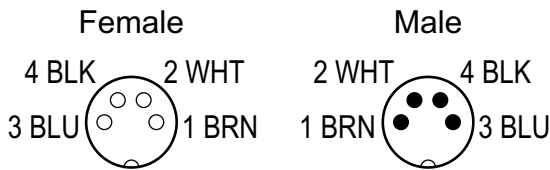

Wiring Diagrams

EVT421, EVT422, EVT423, EVT424, EVT425, EVT426

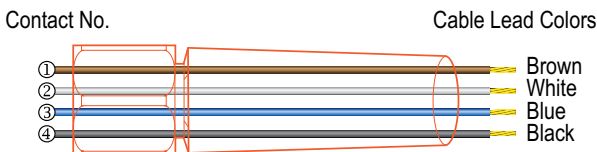

EVT428, EVT429, EVT430, EVT431, EVT433, EVT434, EVT435, EVT436

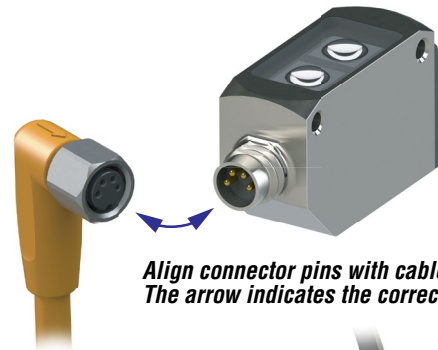
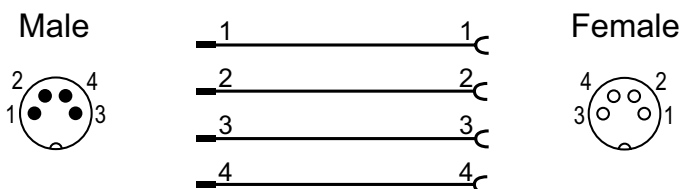

Align connector pins with cable socket. The arrow indicates the correct position.

For applications in harsh environments, tighten the coupling nut with a 9mm wrench to a torque range from 0.3 – 0.5 N·m.

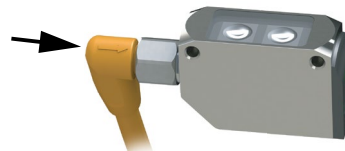
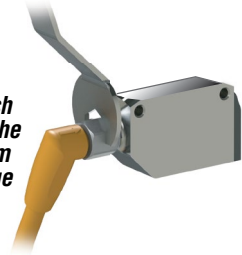

To remove, press the connector against the sensor and loosen the coupling nut.

IP69K-rated M8 Sensor Cables

Dimensions

mm [inches]

Figure 1

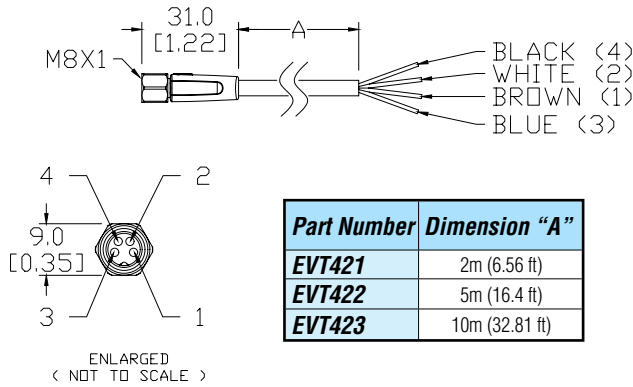

Figure 2

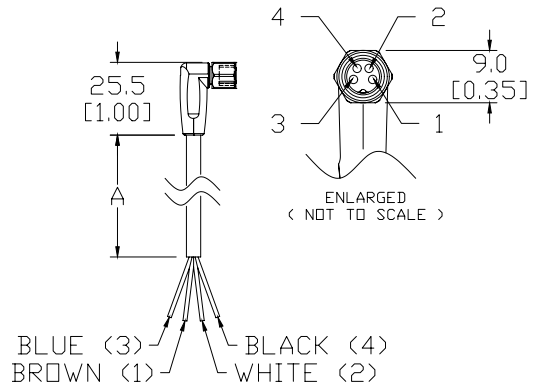

Figure 3

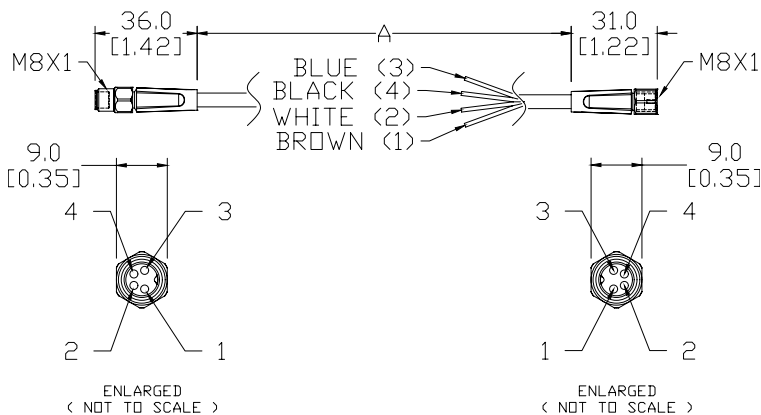

Figure 4

