



stay connected

Connection Cables - Sensor and Signal

FDA Compliant M12 A-coded Cable to Pigtail

Features

- Industry standard axial and 90-degree M12 connectors with open leads
- 2m [6.5 ft], 3m [9.8 ft], 5m [16.4 ft], 7m [22.9 ft], 10m [32.8 ft], 15m [49.2 ft], 20m [65.6 ft] and 25m [82ft] cable lengths
- IP69K rated to withstand high pressure, high temperature wash-down applications
- Food grade TPE-S (Styrene-Butadiene Thermoplastic Elastomer) jacket for food and beverage industrial applications

M12 A-Coded Cable to Pigtail									
Part Number	Price	Number of Wires	Connector	Cable Jacket/ Wire Insulation Material	Jacket Color	Dimensions (mm [in])			
						A	B	C	L (m [ft])
7024-12181-3150500	\$19.50	3	Axial female	TPE-S/PP	Ice blue	39 [1.5]	15 [0.6]	n/a	5 [16.4]
7024-12221-3210200	\$16.00	4							2 [6.5]
7024-12221-3210300	\$18.50								3 [9.8]
7024-12221-3210500	\$20.50								5 [16.4]
7024-12221-3210700	\$25.00								7 [22.9]
7024-12221-3211000	\$29.50								10 [32.8]
7024-12221-3211500	\$37.50								15 [49.2]
7024-12221-3212000	\$47.00								20 [65.6]
7024-12221-3212500	\$56.00								25 [82]
7024-12241-3390200	\$20.50	5							2 [6.5]
7024-12241-3390300	\$22.00								3 [9.8]
7024-12241-3390500	\$25.00								5 [16.4]
7024-12241-3390700	\$29.50								7 [22.9]
7024-12241-3391000	\$34.50								10 [32.8]
7024-12241-3391500	\$45.50								15 [49.2]
7024-12241-3392000	\$55.00								20 [65.6]
7024-12241-3392500	\$63.00		25 [82]						
7024-12321-3150500	\$19.50	3	90-degree female	TPE-S/PP	Ice blue	37 [1.46]	15 [0.6]	29 [1.1]	5 [16.4]
7024-12341-3210200	\$16.00	4							2 [6.5]
7024-12341-3210300	\$18.50								3 [9.8]
7024-12341-3210500	\$20.50								5 [16.4]
7024-12341-3210700	\$25.00								7 [22.9]
7024-12341-3211000	\$29.50								10 [32.8]
7024-12341-3211500	\$37.50								15 [49.2]
7024-12341-3212000	\$47.00								20 [65.6]
7024-12341-3212500	\$56.00								25 [82]
7024-12361-3390200	\$20.50	5							2 [6.5]
7024-12361-3390300	\$22.00								3 [9.8]
7024-12361-3390500	\$25.00								5 [16.4]
7024-12361-3390700	\$29.50								7 [22.9]
7024-12361-3391000	\$34.50								10 [32.8]
7024-12361-3391500	\$45.50								15 [49.2]
7024-12361-3392000	\$55.00								20 [65.6]
7024-12361-3392500	\$63.00		25 [82]						

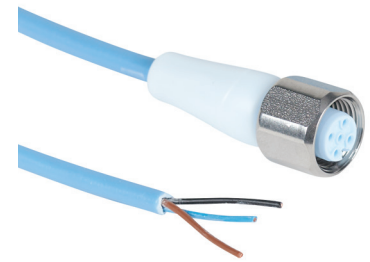

[7024-12181-3150500](#)

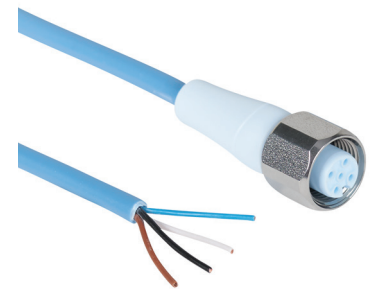

[7024-12221-3210200](#)

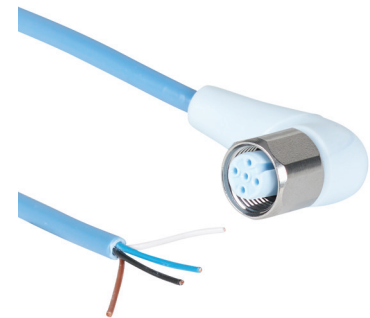

[7024-12341-3210200](#)

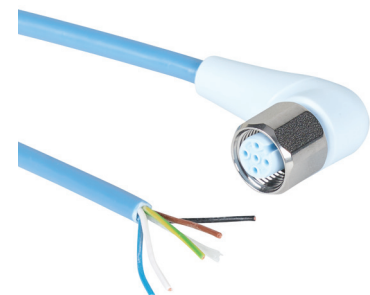

[7024-12361-3390300](#)

Connection Cables - Sensor and Signal

M12 A-coded Cable to Pigtail Specifications			
Model	7024 Series		
Type	3-Wire, 5-Pole	4-Wire, 5-Pole	5-Wire, 5-Pole
Max Voltage	250 VAC/VDC		125 VAC/VDC
Max Voltage - UL Rating	30 VAC/VDC		
Max contact Per Contact	4A		
Protection Degree	IP65 / IP68 / IP69K		
Nut Material	Stainless steel		
Cable Jacket/Wire Insulation Material	TPE-S/PP		
Contacts Material	Copper-Tin alloy		
Tightening Torque	0.6 N·m [0.44 ft-lb]		
Conductors Cross Section	0.34 mm ² [22AWG]		
Ø Outer Cable	4.3 mm [0.17 in]	4.7 mm [0.18 in]	5.0 mm [0.20 in]
Temperature Range - Stationary Use	-40 to 105°C [-40 to 221°F]		
Temperature Range - Flexible Use	-25 to 105°C [-13 to 221°F]		
Min Bend Radius	Stationary use: 5 x cable diameter; Flexible use: 10 x cable diameter		
Approvals*	cULus		

* To obtain the most current agency approval information, see the Agency Compliance & Certifications Checklist section on the specific part number's web page.

Dimensions

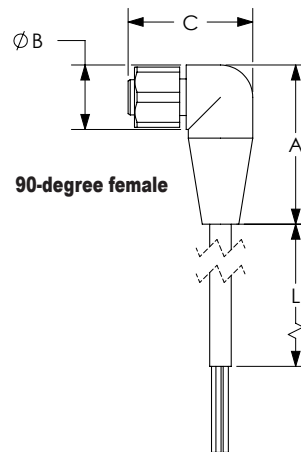
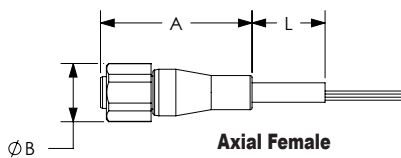

Contact Diagrams

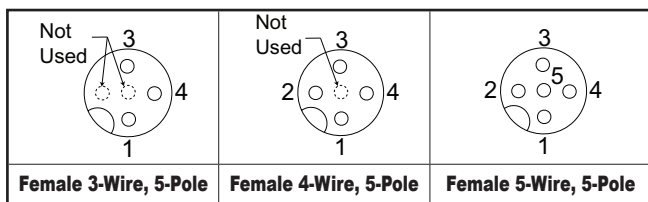

Wiring Diagrams

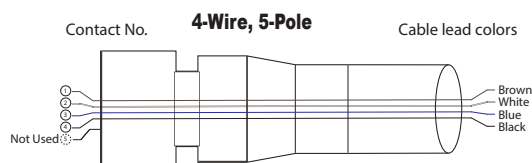
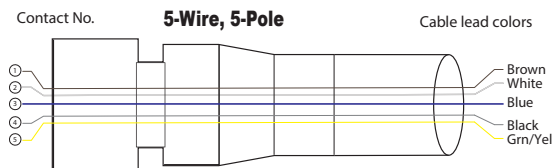
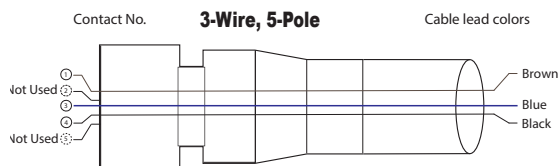

FDA Compliant M12 A-Coded Male to Female Cables

Features

- Available patch cables include:
 - Industry standard M12 screw-lock connectors
 - One male and one female connector
 - Axial and 90-degree connector models
 - 1m [3.2 ft], 3m [9.8 ft] and 5m [16.4 ft] cable lengths
- IP69K rating, suitable for food and beverage industrial applications
- TPE-S (Styrene-Butadiene Thermoplastic Elastomer) jacket for food and beverage industrial applications



7024-40021-3210100



7024-40261-3210100

M12 A-coded Male to Female Cables (Euro, Micro DC-Single Key)										
Part Number	Price	Number of Wires	Connectors	Cable Jacket/ Wire Insulation Material	Jacket Color	Dimensions (mm [in])				
						A	B	C	D	L (m [ft])
7024-40021-3210100	\$23.50	4	Axial male to axial female	TPE-S /PP	Ice Blue	42 [1.65]	39 [1.5]	15 [0.6]	n/a	1 [3.2]
7024-40021-3210300	\$27.00									3 [9.8]
7024-40021-3210500	\$30.50									5 [16.4]
7024-40261-3210100	\$26.00		90-degree male to 90-degree female			32 [1.26]	29 [1.1]	15 [0.6]	37 [1.46]	1 [3.2]
7024-40261-3210300	\$29.50									3 [9.8]
7024-40261-3210500	\$33.50									5 [16.4]
7024-40041-3390100	\$27.00	5	Axial male to axial female			42 [1.65]	39 [1.5]	15 [0.6]	n/a	1 [3.2]
7024-40041-3390300	\$30.50									3 [9.8]
7024-40041-3390500	\$33.50									5 [16.4]

M12 A-coded Male to Female Cables Specifications		
Model	7024 Series	
Type	4-Wire, 5-Pole	5-Wire, 5-Pole
Max Voltage	250 VAC/VDC	125 VAC/VDC
Max Voltage - UL Rating	30 VAC/VDC	
Max Current Per Contact	4A	
Protection Degree	IP65 / IP68 / IP69K	
Nut Material	Stainless steel	
Cable Jacket/Wire Insulation Material	TPE-S/PP	
Contact Material	Copper-Tin Alloy	
Tightening Torque	0.6 N·m [0.44 ft-lb]	
Conductors Cross Section	0.34 mm ² [22AWG]	
Ø Outer Cable	4.7 mm [0.18 in]	5.0 mm [0.20 in]
Temperature Range - Stationary Use	-40 to 105°C [-40 to 221°F]	
Temperature Range - Flexible Use	-25 to 105°C [-13 to 221°F]	
Min Bend Radius	Stationary use: 5 x cable diameter; Flexible use: 10 x cable diameter	
Approvals*	cULus	

* To obtain the most current agency approval information, see the Agency Compliance & Certifications Checklist section on the specific part number's web page.

Connection Cables - Sensor and Signal

Dimensions

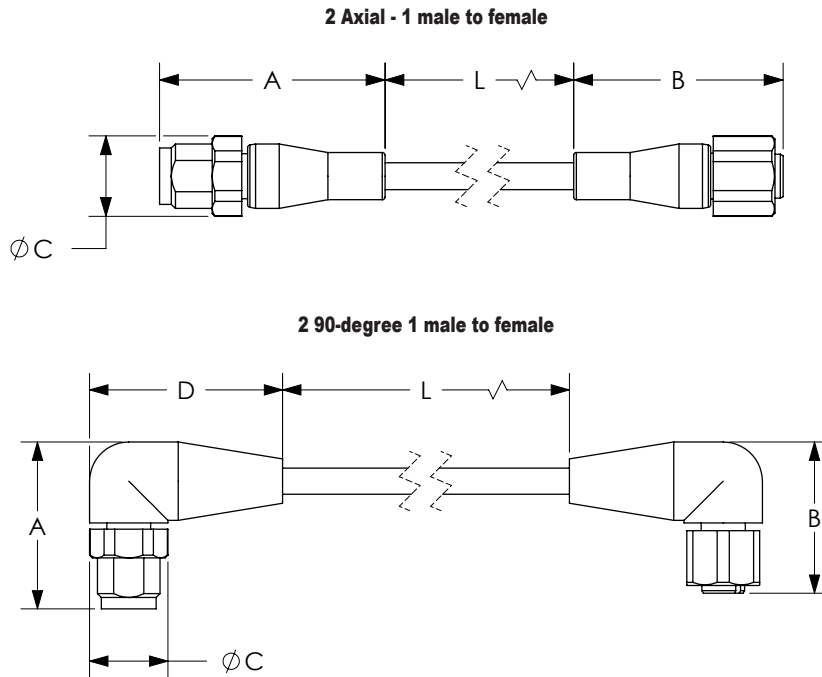

Contact Diagrams

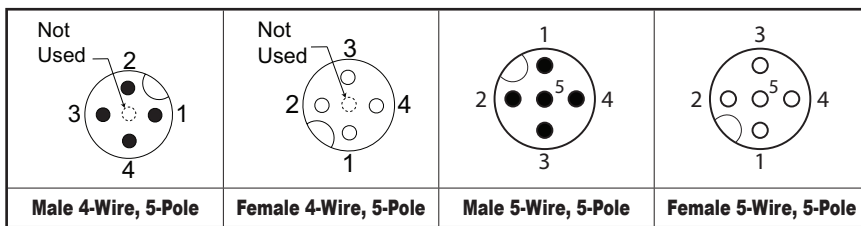

Wiring Diagrams

