

HydroMode™ Potable Water Push-to-Connect Fittings

HydroMode push-to-connect union Y fitting with acetel body and synthetic rubber o-ring. For use with polyethylene and other flexible tubing. Five fittings per package.

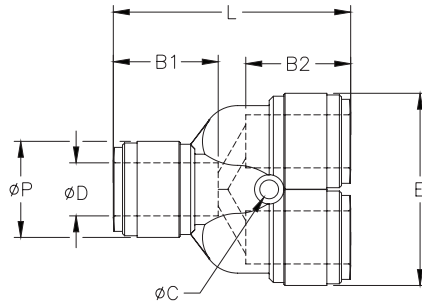

HydroMode™ Union Y										
Inch Sizes - dimensions in millimeters (mm) unless otherwise noted										
Part No.	Price	Size (inch)	ØD (inch)	B1	B2	ØP	L	Ø	Package Weight (lbs)	Qty. per pack
UY532-P	\$12.00	5/32 in.	5/32	14.7	14.7	13.8	33.7	3.3	0.1	5
UY14-P	\$12.00	1/4 in.	1/4	16.9	16.9	15.5	38.8	3.3	0.1	5
UY516-P	\$13.00	5/16 in.	5/16	17.5	17.5	17.6	41.0	4.5	0.1	5
UY38-P	\$12.00	3/8 in.	3/8	20.2	20.2	20.0	46.4	4.5	0.2	5
UY12-P	\$15.00	1/2 in.	1/2	25.1	25.1	23.0	56.8	4.5	0.3	5

HydroMode push-to-connect NPT stem adapter fitting with acetel body and synthetic rubber o-ring. Five fittings per package.

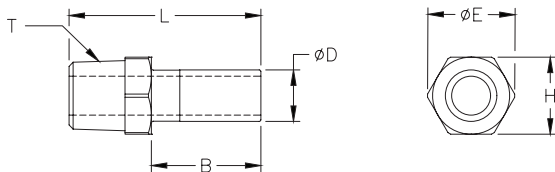

HydroMode™ NPT Stem Adapter											
Inch Sizes - dimensions in millimeters (mm) unless otherwise noted											
Part No.	Price	Size (inch)	ØD (inch)	T (NPTF)	B	ØE	H (inch)	L	Package Weight (lbs)	Qty. per pack	
SA532-18N-P	\$4.00	5/32 in. x 1/8 NPT	5/32	1/8	18.0	14.1	12.7 (1/2)	33.1	0.1	5	
SA532-14N-P	\$4.00	5/32 in. x 1/4 NPT	5/32	1/4	18.0	17.8	15.8 (5/8)	37.2	0.1	5	
SA14-18N-P	\$4.00	1/4 in. x 1/8 NPT	1/4	1/8	19.0	14.1	12.7 (1/2)	34.1	0.1	5	
SA14-14N-P	\$4.25	1/4 in. x 1/4 NPT	1/4	1/4	19.0	17.8	15.8 (5/8)	38.2	0.1	5	
SA516-18N-P	\$4.00	5/16 in. x 1/8 NPT	5/16	1/8	20.0	14.1	12.7 (1/2)	35.1	0.1	5	
SA516-14N-P	\$4.25	5/16 in. x 1/4 NPT	5/16	1/4	20.0	17.8	15.8 (5/8)	39.2	0.1	5	
SA516-38N-P	\$4.25	5/16 in. x 3/8 NPT	5/16	3/8	20.0	21.5	19.0 (3/4)	40.3	0.1	5	
SA38-14N-P	\$4.25	3/8 in. x 1/4 NPT	3/8	1/4	23.0	17.8	15.8 (5/8)	42.2	0.1	5	
SA38-38N-P	\$4.50	3/8 in. x 3/8 NPT	3/8	3/8	23.0	21.5	19.0 (3/4)	43.3	0.1	5	
SA12-38N-P	\$4.50	1/2 in. x 3/8 NPT	1/2	3/8	27.0	21.5	19.0 (3/4)	47.3	0.1	5	
SA12-12N-P	\$5.00	1/2 in. x 1/2 NPT	1/2	1/2	27.0	26.8	23.8 (15/16)	51.3	0.1	5	

HydroMode™ Potable Water Push-to-Connect Fittings

HydroMode push-to-connect fittings are designed to work with potable water and beverages. Installing or removing flexible tubing is quick and easy. All fittings are made of NSF approved materials with NSF-51® and NSF-61® certifications. The body and collet of the fittings are made from polyoxymethylene (POM) also known as acetal, while the o-rings are made from ethylene propylene diene monomer (EPDM) which is a type of synthetic rubber.

Features

- Designed for potable water and beverages
- NSF-51 and NSF-61 certified
- Easy tubing installation and removal
- Optional retaining clips prevent accidental tube removal
- Fittings rated for up to 145psi at 70°C (158°F)

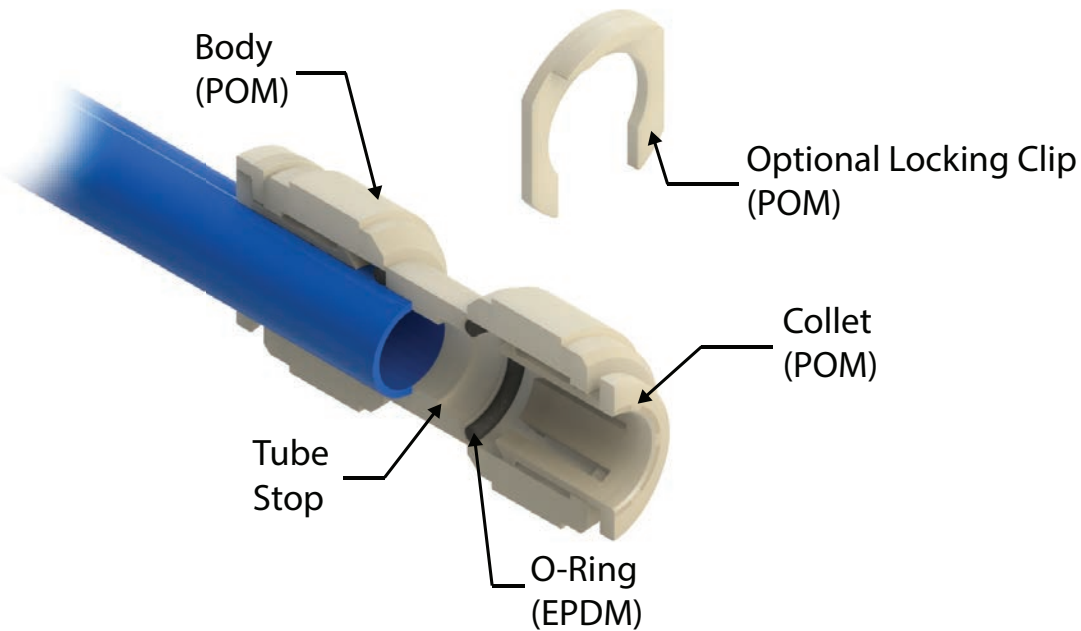

*Push-to-Connect Fitting
Cut-away Diagram*