

NEMA 4 and 4X Extra Deep Stainless Steel Pushbutton



Applications

- Designed to accept standard heavy duty oil-tight pushbuttons, switches and pilot lights.
- Provides protection from dirt, dust, oil and water.

Construction

- Smooth continuously welded seams.
- Welded brackets provide for enclosure mounting.
- Captive cover screws fasten into threaded, sealed wells.
- Larger enclosures provide internally hinged removable covers, designed to hold the cover open during wiring (see drawings).
- Oil-resistant gasket and adhesive.
- A bonding stud is provided on the door and a grounding stud is provided on the enclosure.

Finish

- Natural stainless steel with a #4 smooth brushed finish.

Listings

- UL 508A Type 4 and 4X [UL File E65324]
- CSA Type 4 and 4X [CSA File LR21001]
- Complies with
 - NEMA Type 4 and 4X
 - IEC 60529, IP66
- All appropriate components are required to maintain these standards.



Shipping Schedule	
Same day	1 - 15 days
Color indicates shipping lead time in business days.	

NEMA 4 and 4X Extra Deep Stainless Steel Pushbutton											
304 Stainless Steel				316 Stainless Steel				Console Size HxWxD	# Holes	Steel Gauge	Hinged
22mm	Price	30mm	Price	22mm	Price	30mm	Price				
1437MSSA	\$153.00	1437SSA	\$148.00	1437MS16A	\$199.00	1437S16A	\$184.00	4.31 x 4.31 x 4.91 [109 x 109 x 125]	1	16	No
1437MSSB	\$188.00	1437SSB	\$182.00	1437MS16B	\$244.00	1437S16B	\$226.00	6.31 x 4.31 x 4.92 [160 x 109 x 125]	2	14	Yes
1437MSSC	\$218.00	1437SSC	\$211.00	1437MS16C	\$283.00	1437S16C	\$262.00	8.31 x 4.31 x 4.92 [211 x 109 x 125]	3		
1437MSSD	\$244.00	1437SSD	\$237.00	1437MS16D	\$319.00	1437S16D	\$294.00	10.31 x 4.31 x 4.92 [262 x 109 x 125]	4		
-	-	1437SSS	\$467.00	-	-	1437S16S	\$557.00	12.06 x 11.06 x 4.92 [306 x 281 x 125]	16		

Note: Dimensions in inches [millimeters].

NEMA 4 and 4X Extra Deep Stainless Steel Pushbutton



Dimensions

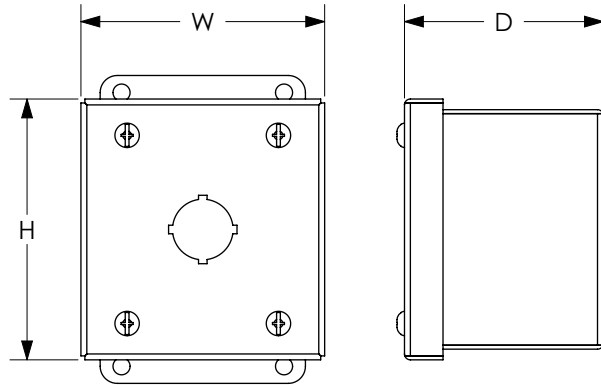

22mm Hole Placement

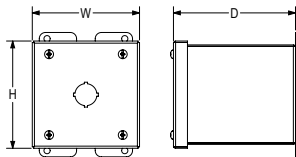

33mm Hole Placement

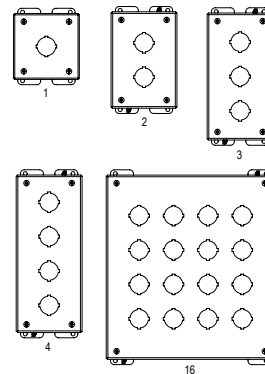
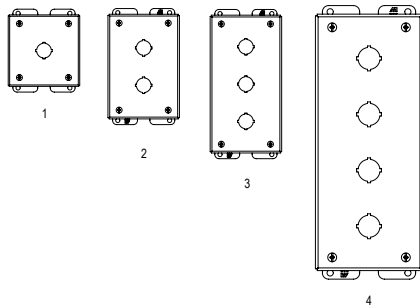
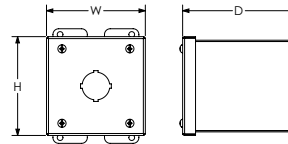

See our website: www.AutomationDirect.com for complete engineering drawings.