







Pneumatic GVP Series Miniature Solenoid Valve Manifolds



NITRA manifolds designed to work with 15mm wide GVP series valves.

- Single to 4 stations
- #10-32 threaded or 1/8in NPT female ports
- Precision machined
- Compact
- Anodized aluminum for corrosion resistance
- Made in USA



Nitra Pneumatic GVP Series 15mm Miniature Solenoid Valve Manifolds					
Item	Part No.	Description	A inches [mm]	Price	Weight (lbs)
	<u>GM-321</u>	NITRA pneumatic valve manifold, anodized aluminum, rectangular, (1) station, #10-32 female threaded inlet(s), #10-32 female threaded outlet(s), #10-32 female threaded exhaust(s). For use with GVP-22 and GVP-32 series solenoid valves.	N/A	\$18.00	0.05
	<u>GM-322</u>	NITRA pneumatic valve manifold, anodized aluminum, rectangular, (2) stations, 1/8in female NPT inlet(s), #10-32 female threaded outlet(s), 1/8in female NPT exhaust(s). For use with GVP-22 and GVP-32 series solenoid valves.	2.13 [54.0]	\$22.00	0.15
	<u>GM-324</u>	NITRA pneumatic valve manifold, anodized aluminum, rectangular, (4) stations, 1/8in female NPT inlet(s), #10-32 female threaded outlet(s), 1/8in female NPT exhaust(s). For use with GVP-22 and GVP-32 series solenoid valves.	3.37 [85.7]	\$29.50	0.25
	<u>GM-321-18N</u>	NITRA pneumatic valve manifold, anodized aluminum, rectangular, (1) station, 1/8in female NPT inlet(s), 1/8in female NPT outlet(s), vent hole exhaust(s). For use with GVP-22 and GVP-32 series solenoid valves.	N/A	\$20.50	0.6

Assembly Example

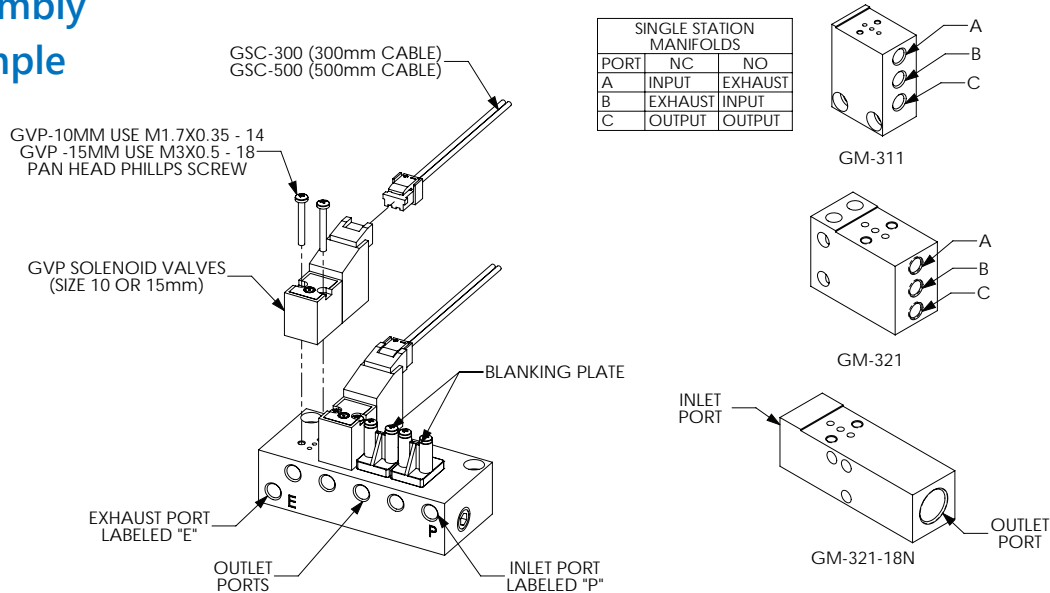



Pneumatic GVP Series Miniature Solenoid Valve Manifolds

Dimensions

mm [inches]

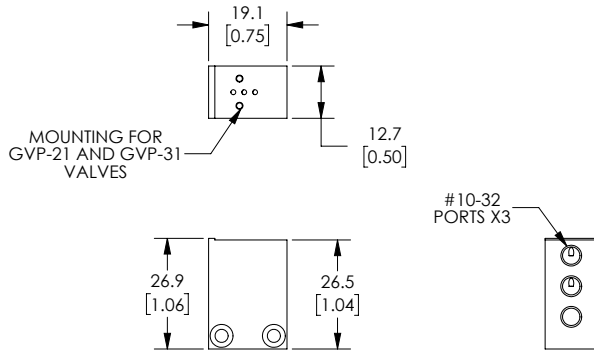

Part No. GM-311

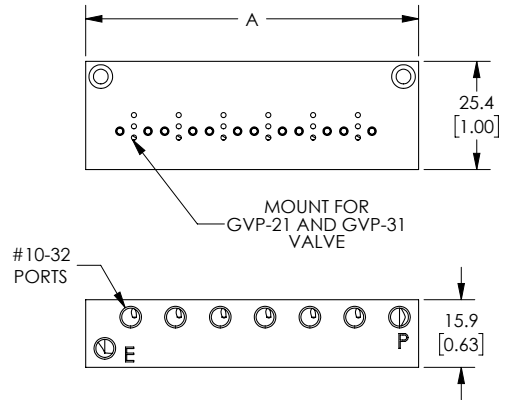

Part No. GM-312, GM-314, GM-316

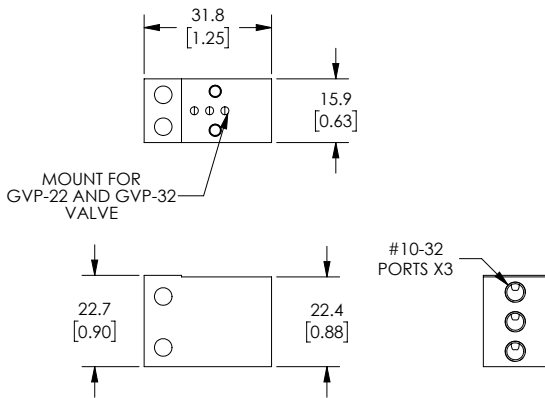

Part No. GM-321

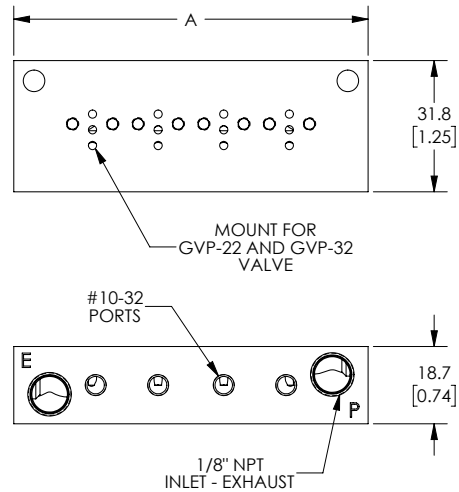

Part No. GM-322, GM-324

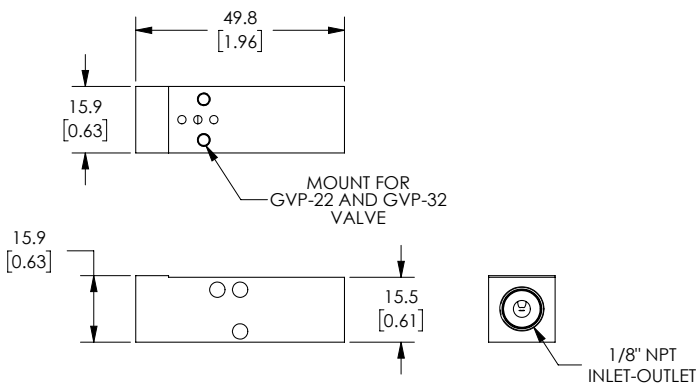





Part No. GM-321-18N

See our website www.AutomationDirect.com for complete Engineering drawings.



Pneumatic GVP Series Miniature Solenoid Manifold Accessories



Nitra Pneumatic GVP Series Miniature Solenoid Valve Manifold Accessories				
Item	Part No.	Description	Price	Weight (lbs)
	<u>GM-31BP</u>	NITRA blanking plate, nylon. For use with GM-31 series manifolds. Gasket and mounting screws included.	\$4.75	0.05
	<u>GM-32BP</u>	NITRA blanking plate, nylon. For use with GM-32 series manifolds. Gasket and mounting screws included.	\$4.00	0.05
	<u>GSC-300</u>	NITRA solenoid valve cable, miniature pin plug to pigtail, 11.8in/300mm cable length. For use with GVP series solenoid valves.	\$4.25	0.05
	<u>GSC-500</u>	NITRA solenoid valve cable, miniature pin plug to pigtail, 19.6in/500mm cable length. For use with GVP series solenoid valves.	\$4.25	0.05

Dimensions

mm [inches]

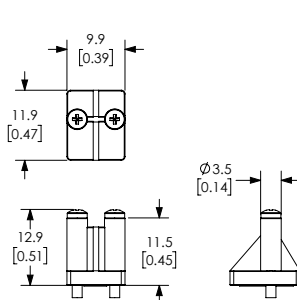

Part No. GM-31BP

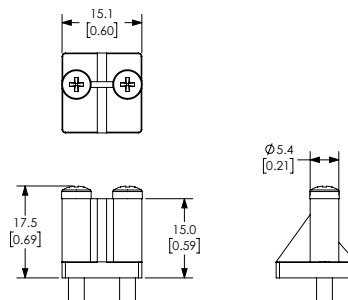

Part No. GM-32BP

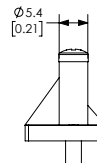

See our website www.AutomationDirect.com for complete Engineering drawings.