



Pneumatic GVP Series Miniature Solenoid Valves



Part No. GVP-211C-12D



Part No. GVP-321C-12D

NITRA™ pneumatic miniature solenoid valves are an excellent choice for many automation applications with low flow requirements. Valves must be mounted to a GM-3 series manifold (sold separately).

Features

- 10mm and 15mm valve widths
- Available in 2-way or 3-way normally closed configurations
- 12 or 24 VDC solenoids
- GM-3 series manifolds sold separately



See www.AutomationDirect.com for a wide variety of fitting options

Diagram "A"

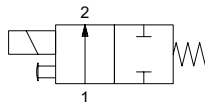

2-way, 2-position, Spring Return

Diagram "B"

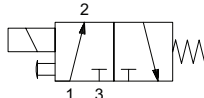

3-way, 2-position, Spring Return

GVP Series Miniature Solenoid Valves							
Model	GVP-211C-12D	GVP-211C-24D	GVP-311C-12D	GVP-311C-24D	GVP-221C-12D	GVP-321C-12D	GVP-321C-24D
Price	\$30.00	\$30.00	\$30.00	\$30.00	\$26.00	\$26.00	\$26.00
Weight (lbs)	0.05				0.1		
Size	10mm				15mm		
Valve Type	2-way, 2-position, Normally Closed		3-way, 2-position, Normally Closed		2-way, 2-position, Normally Closed	3-way, 2-position, Normally Closed	
Acting Diagram	A		B		A	B	
Fluid	Air or Inert Gas (to be filtered by 40µ filter element)						
Min. / Max. Pressure	0 to 105 psi (0 to 7.24 bar)						
Flow (Cv)	0.013	0.13	0.13	0.13	0.047	0.47	0.47
Port	Requires GM type 10mm or 15mm manifolds for operation						
Voltage	12VDC	24VDC	12VDC	24VDC	12VDC	12VDC	24VDC
Continuous ON Power	1.3 W				1.6 W		
Expected Life	50,000,000 cycles at max 3 cycles/second						
Wiring	Connector Receptacle (Wire connector required)				18" Flying Leads		
Response Time	6ms (on), 8ms (off)						
Indication	LED						
Temperature - Operation and Storage	14-122°F (-10-50°C)						
Lubrication	Not Required						
Body	Glass-filled nylon						
Protection	n/a						



Pneumatic GVP Series Miniature Solenoid Valves

Dimensions

mm [inches]

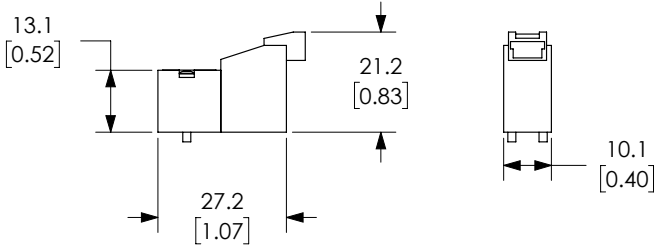

GVP-x11C-xxD

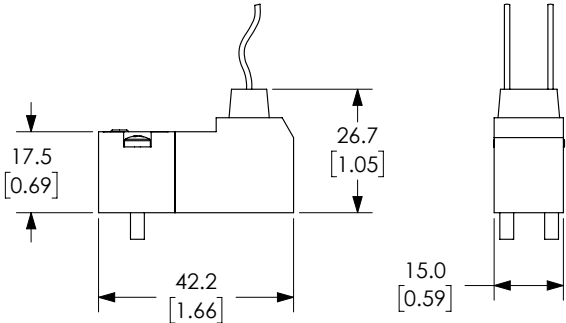

GVP-x21C-xxD

See our website www.AutomationDirect.com for complete Engineering drawings.







Pneumatic GVP Series Miniature Solenoid Valve Manifolds



NITRA manifolds designed to work with 10mm wide GVP series valves.

- Single to 6 stations
- #10-32 female threaded ports
- Precision machined
- Compact
- Anodized aluminum for corrosion resistance
- Made in USA



Nitra Pneumatic GVP Series 10mm Miniature Solenoid Valve Manifolds					
Item	Part No.	Description	A inches [mm]	Price	Weight (lbs)
	GM-311	NITRA pneumatic valve manifold, anodized aluminum, rectangular, 1 stations, #10-32 female threaded inlet(s), #10-32 female threaded outlet(s), #10-32 female threaded exhaust(s). For use with GVP-21 and GVP-31 series solenoid valves.	N/A	\$16.50	0.05
	GM-312	NITRA pneumatic valve manifold, anodized aluminum, rectangular, 2 stations, #10-32 female threaded inlet(s), #10-32 female threaded outlet(s), #10-32 female threaded exhaust(s). For use with GVP-21 and GVP-31 series solenoid valves.	1.42 [36.1]	\$23.00	0.05
	GM-314	NITRA pneumatic valve manifold, anodized aluminum, rectangular, 4 stations, #10-32 female threaded inlet(s), #10-32 female threaded outlet(s), #10-32 female threaded exhaust(s). For use with GVP-21 and GVP-31 series solenoid valves.	2.25 [78.2]	\$25.50	0.10
	GM-316	NITRA pneumatic valve manifold, anodized aluminum, rectangular, 6 stations, #10-32 female threaded inlet(s), #10-32 female threaded outlet(s), #10-32 female threaded exhaust(s). For use with GVP-21 and GVP-31 series solenoid valves.	3.08 [78.2]	\$30.00	0.15

Assembly Example

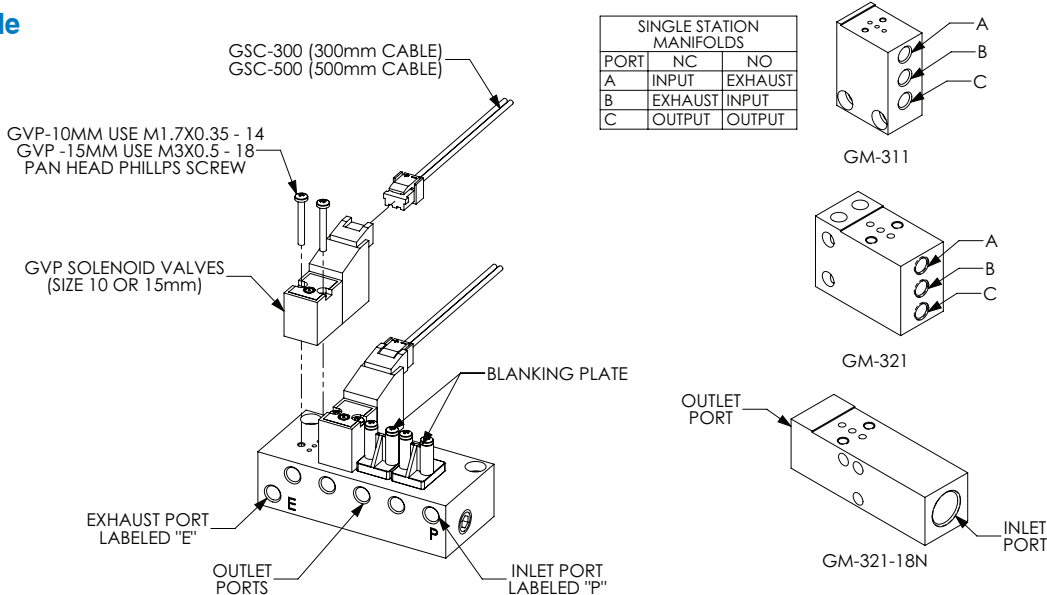







Pneumatic GVP Series Miniature Solenoid Valve Manifolds



NITRA manifolds designed to work with 15mm wide GVP series valves.

- Single to 4 stations
- #10-32 threaded or 1/8in NPT female ports
- Precision machined
- Compact
- Anodized aluminum for corrosion resistance
- Made in USA



Nitra Pneumatic GVP Series 15mm Miniature Solenoid Valve Manifolds					
Item	Part No.	Description	A inches [mm]	Price	Weight (lbs)
	GM-321	NITRA pneumatic valve manifold, anodized aluminum, rectangular, 1 stations, #10-32 female threaded inlet(s), #10-32 female threaded outlet(s), #10-32 female threaded exhaust(s). For use with GVP-22 and GVP-32 series solenoid valves.	N/A	\$17.00	0.05
	GM-322	NITRA pneumatic valve manifold, anodized aluminum, rectangular, 2 stations, 1/8in female NPT inlet(s), #10-32 female threaded outlet(s), 1/8in female NPT exhaust(s). For use with GVP-22 and GVP-32 series solenoid valves.	2.13 [54.0]	\$21.00	0.15
	GM-324	NITRA pneumatic valve manifold, anodized aluminum, rectangular, 4 stations, 1/8in female NPT inlet(s), #10-32 female threaded outlet(s), 1/8in female NPT exhaust(s). For use with GVP-22 and GVP-32 series solenoid valves.	3.37 [85.7]	\$28.00	0.25
	GM-321-18N	NITRA pneumatic valve manifold, anodized aluminum, rectangular, 1 stations, 1/8in female NPT inlet(s), 1/8in female NPT outlet(s), 1/8in female NPT exhaust(s). For use with GVP-22 and GVP-32 series solenoid valves.	N/A	\$19.50	0.6

Assembly Example

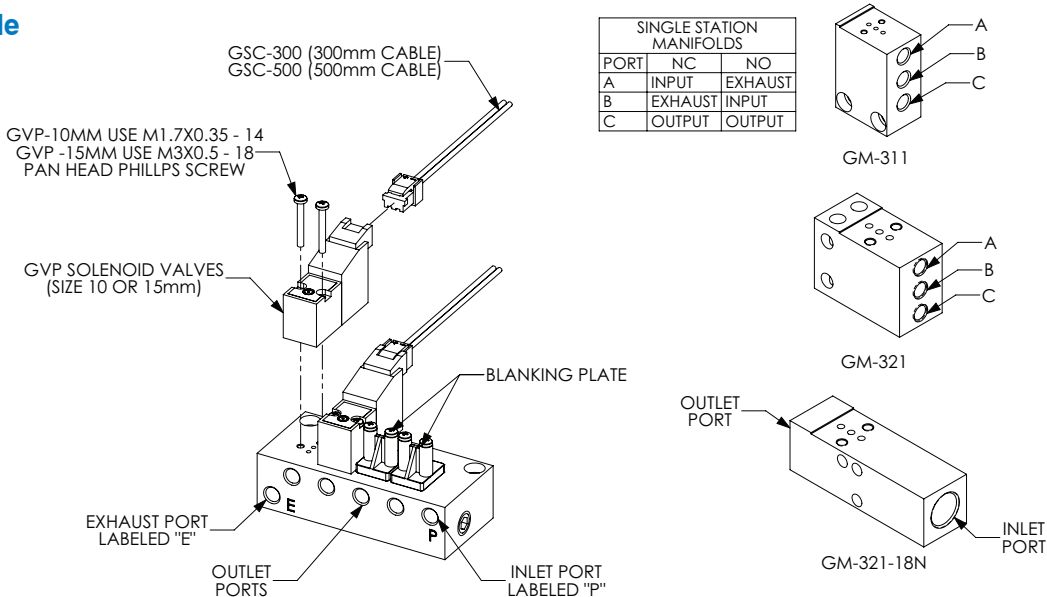



Pneumatic GVP Series Miniature Solenoid Valve Manifolds

Dimensions

mm [inches]

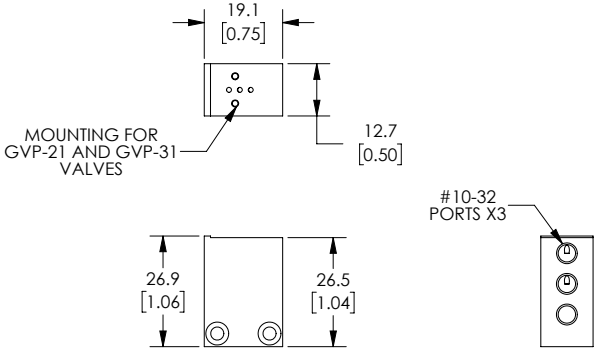

Part No. GM-311

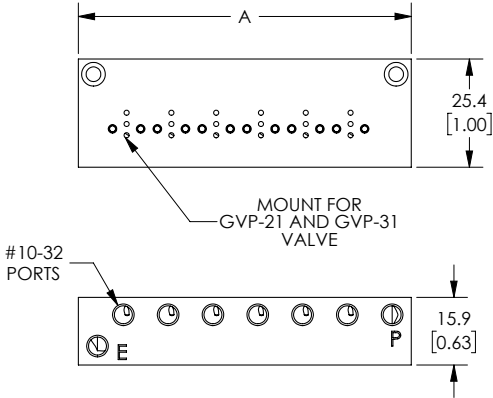

Part No. GM-312, GM-314, GM-316

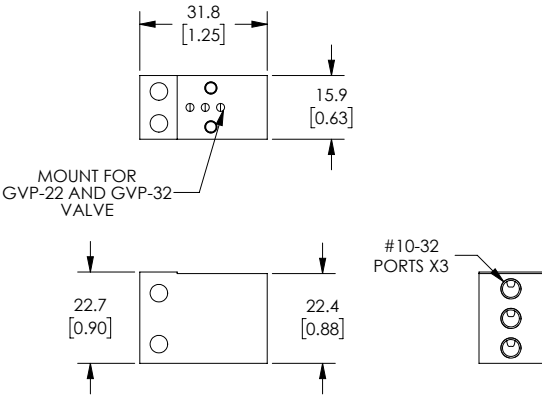

Part No. GM-321

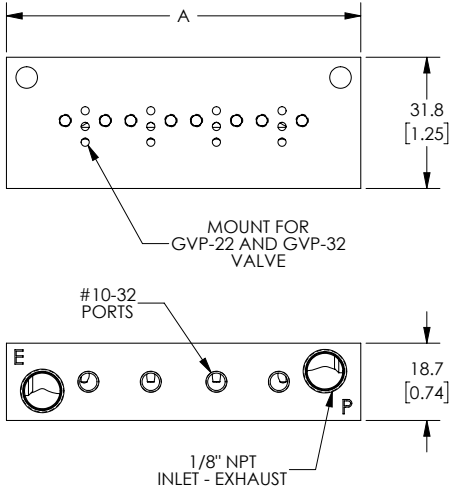

Part No. GM-322, GM-324

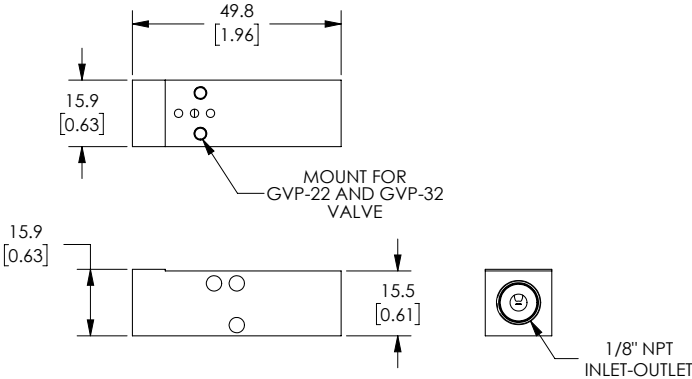





Part No. GM-321-18N

See our website www.AutomationDirect.com for complete Engineering drawings.



Pneumatic GVP Series Miniature Solenoid Manifold Accessories



Nitra Pneumatic GVP Series Miniature Solenoid Valve Manifold Accessories				
Item	Part No.	Description	Price	Weight (lbs)
	GM-31BP	NITRA blanking plate, nylon. For use with GM-31 series manifolds. Gasket and mounting screws included.	\$4.75	0.05
	GM-32BP	NITRA blanking plate, nylon. For use with GM-32 series manifolds. Gasket and mounting screws included.	\$4.00	0.05
	GSC-300	NITRA solenoid valve cable, miniature pin plug to pigtail, 11.8in/300mm cable length. For use with GVP series solenoid valves.	\$4.25	0.05
	GSC-500	NITRA solenoid valve cable, miniature pin plug to pigtail, 19.6in/500mm cable length. For use with GVP series solenoid valves.	\$4.25	0.05

Dimensions

mm [inches]

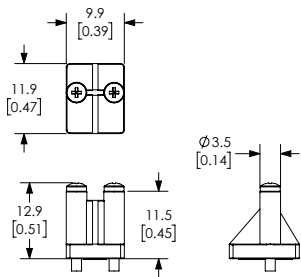

Part No. GM-31BP

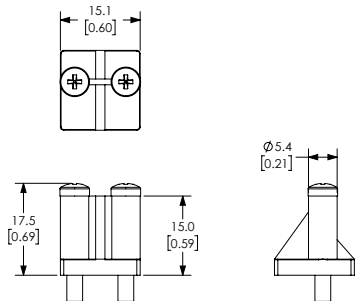

Part No. GM-32BP

See our website www.AutomationDirect.com for complete Engineering drawings.