

Fuji Miniature DIN Super Timers



Overview

The ST7P is a compact and highly accurate timer. It is an on-delay operation type with a single timing range. These timers are designed to optimize mounting space in small areas. Mounting is by DIN rail or by securing directly to a panel with a fastener.

Features

- Highly accurate, with a repeat accuracy within $\pm 1\%$ at maximum setting time
- ST7P models offer a number of timing ranges. Please see Selection Guide below
- Large dial makes time setting easy
- LED indicators make it easy to monitor timer operation
- ST7P series meets UL and CSA standards

Fuji Miniature DIN Super Timers Selection Chart

Part Number	Price	Description	Voltage	Time Range
<u>ST7P-2A15S-ADC</u>	\$51.00	Mini-DIN on-delay timer with timing range of 0.4s to 5s. Input power is 100-120 VAC. DPDT relay output. UL, CSA, TÜV approved	100-120VAC	0.4 seconds to 5 seconds
<u>ST7P-2A13T-ADC</u>	\$51.00	Mini-DIN on-delay timer with timing range of 2s to 30s. Input power is 100-120 VAC. DPDT relay output. UL, CSA, TÜV approved		2 seconds to 30 seconds
<u>ST7P-2A16T-ADC</u>	\$51.00	Mini-DIN on-delay timer with timing range of 4s to 60s. Input power is 100-120 VAC. DPDT relay output. UL, CSA, TÜV approved		4 seconds to 60 seconds
<u>ST7P-2A11N-ADC</u>	\$51.00	Mini-DIN on-delay timer with timing range of 1 min. to 10 min. Input power is 100-120 VAC. DPDT relay output. UL, CSA, TÜV approved		1 minute to 10 minutes
<u>ST7P-2A16N-ADC</u>	\$51.00	Mini-DIN on-delay timer with timing range of 4 min. to 60 min. Input power is 100-120 VAC. DPDT relay output. UL, CSA, TÜV approved		4 minutes to 60 minutes
<u>ST7P-2DE5S-ADC</u>	\$51.00	Mini-DIN on-delay timer with timing range of 0.4s to 5s. Input power is 24 VDC. DPDT relay output. UL, CSA, TÜV approved	24VDC	0.4 seconds to 5 seconds
<u>ST7P-2DE3T-ADC</u>	\$51.00	Mini-DIN on-delay timer with timing range of 2s to 30s. Input power is 24 VDC. DPDT relay output. UL, CSA, TÜV approved		2 seconds to 30 seconds
<u>ST7P-2DE6T-ADC</u>	\$51.00	Mini-DIN on-delay timer with timing range of 4s to 60s. Input power is 24 VDC. DPDT relay output. UL, CSA, TÜV approved		4 seconds to 60 seconds
<u>ST7P-2DE1N-ADC</u>	\$49.00	Mini-DIN on-delay timer with timing range of 1 min. to 10 min. Input power is 24 VDC. DPDT relay output. UL, CSA, TÜV approved		1 minute to 10 minutes
<u>ST7P-2DE6N-ADC</u>	\$49.00	Mini-DIN on-delay timer with timing range of 4 min. to 60 min. Input power is 24 VDC. DPDT relay output. UL, CSA, TÜV approved		4 minutes to 60 minutes
<u>TP88X2</u>	\$9.25	DIN rail/surface mount socket for ST7P series timers. UL, CSA, TÜV approved	N/A	N/A

Dimensions

mm [inches]

Timer and Socket Assembly

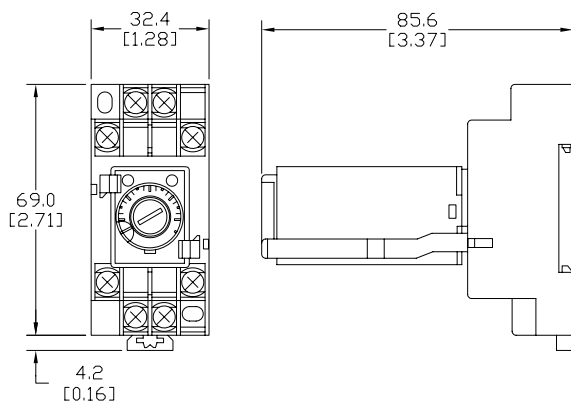

Control

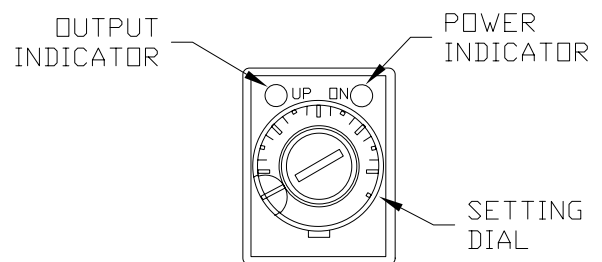

Fuji Miniature DIN Super Timer Specifications

Fuji Miniature DIN Super Timers Specifications			
Repeat Accuracy	±01% at maximum setting time		
Reset Time	0.1 second or less		
Maximum Operating Cycle	1800 cycles/hour		
Operating Voltage Range	<table border="1"> <tr> <td>85-132 VAC 50/60 Hz ST7P-2A15S-ADC ST7P-2A13T-ADC ST7P-2A16T-ADC ST7P-2A11N-ADC ST7P-2A16N-ADC</td> <td>20.4-26.4 VDC ST7P-2DE5S-ADC ST7P-2DE3T-ADC ST7P-2DE6T-ADC ST7P-2DE1N-ADC ST7P-2DE6N-ADC</td> </tr> </table>	85-132 VAC 50/60 Hz ST7P-2A15S-ADC ST7P-2A13T-ADC ST7P-2A16T-ADC ST7P-2A11N-ADC ST7P-2A16N-ADC	20.4-26.4 VDC ST7P-2DE5S-ADC ST7P-2DE3T-ADC ST7P-2DE6T-ADC ST7P-2DE1N-ADC ST7P-2DE6N-ADC
85-132 VAC 50/60 Hz ST7P-2A15S-ADC ST7P-2A13T-ADC ST7P-2A16T-ADC ST7P-2A11N-ADC ST7P-2A16N-ADC	20.4-26.4 VDC ST7P-2DE5S-ADC ST7P-2DE3T-ADC ST7P-2DE6T-ADC ST7P-2DE1N-ADC ST7P-2DE6N-ADC		
Operating Temperature Range	-10 to +50°C [14 to 122°F]		
Humidity	35 to 85% (no condensation)		
Contact Ratings	3A @ 240 VAC resistive load, 1 A @120 VAC inductive load; 3A @ 30 VDC resistive load, 0.5 A @ 30 VDC inductive load		
Power Consumption	Approx. 1.2 VA at 100 VAC, approx. 1.5 VA at 200 VAC, 1.1 W at 24 VDC.		
Insulation Resistance	100MΩ at 500 VDC insulation tested		
Surge Voltage *	3000 Volts		
Dielectric Strength	2000 VAC 1 min. between current carrying part and non-current carrying part 2000 VAC 1 min. between output contact and control circuit 1000 VAC 1 min. between open contacts		
Vibration	Malfunction durability: 10 to 55Hz, 0.5mm double amplitude Mechanical durability: 10 to 55Hz, 0.7mm double amplitude		
Shock	Malfunction durability: 50m/s ² Mechanical durability: 1000m/s ²		
Life Expectancy	Mechanical: 50 million operations (No load; operation cycle 1800/hr.) Electrical: 500,000 operations (3A @ 220 VAC, resistive load; operation cycle 1800/hr.)		
Weight	36.288 g [1.28 oz]		
Agency Approvals and Standards **	UL file no.: Body - E44592, Socket - E90265; TÜV license no: R9551799		

* Note: If surge voltage exceeds 3000V, use surge suppressors.

** To obtain the most current agency approval information, see the Agency Compliance & Certifications Checklist section on the specific part number's web page.

Fuji Miniature DIN Timers, Dimensions, Timing and Wiring

Dimensions

mm [inches]

ST7P Timer

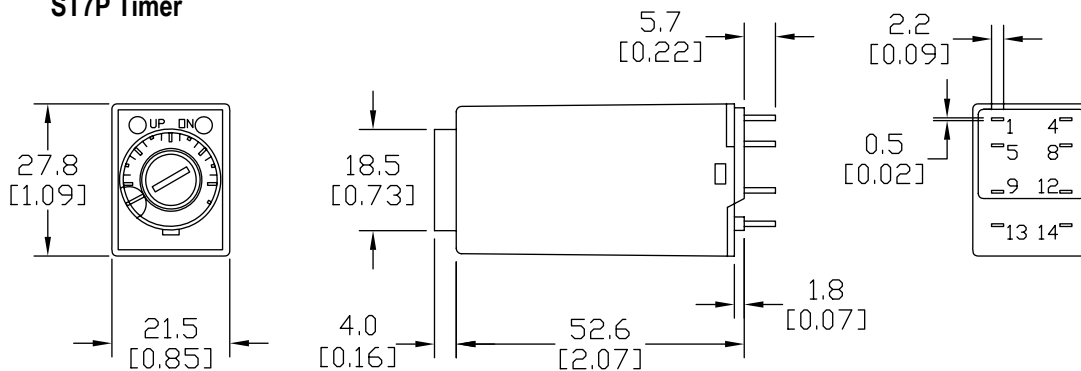

TP88X2 Socket

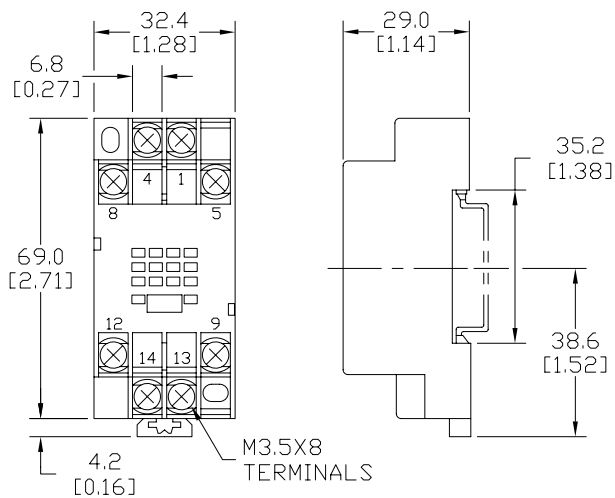

Panel Mounting

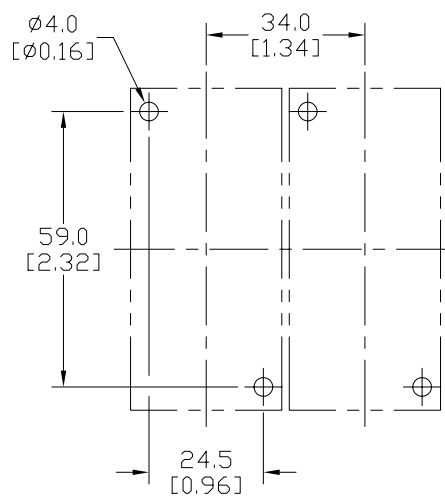

Wiring Diagram

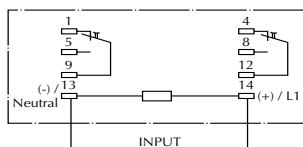

Sockets/Screw Terminal and Rail Mounting

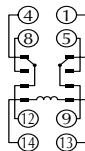

Timing Diagram

