

Fuji Electric Command 22mm Buzzers



DR22B8-EB

Command 22mm Buzzers						
Part Number	Qty	Price	Sound Type	Sound Level	LED Indicator	Operating Voltage
DR22B8-EB	1	\$29.00	Intermittent/continuous electronic sound	80dB @ 0.1 m 60dB @ 1m	-	12-24V AC/DC
DR22B8-HB	1	\$29.00				100-110VAC
DR22B5-EB	1	\$39.00	Intermittent/continuous electronic sound	90dB @ 0.1 m 70dB @ 1m	Red	12-24V AC/DC
DR22B5-HB	1	\$39.00				100-110VAC



DR22B5-HB

Specifications		
	DR22B5	DR22B8
Rated insulation voltage	Without transformer: 60V AC/DC With transformer: 250VAC	
Durability	1000h	
Frequency	2.4 to 3.3 kHz	
Intermittent cycle	Approx. 170-cycle/min	
Dielectric strength	Without transformer: 1000VAC 1 minute With transformer: 2000VAC 1 minute	
Insulation resistance	100MΩ or more (500VDC megger)	
Pollution degree	3	
Vibration	Resonance: 10 to 55Hz, double amplitude 0.1 mm Constant: 16.7 Hz, double amplitude 3.0 mm	
Shock	Mechanical durability: 500 m/s ²	
Ambient temperature	-20° to +60°C [-4° to +140°F] no condensation or no icing	
Storage temperature	-30° to +70°C [-22° to +158°F]	
Humidity	45 to 85% RH (within -5° to 40°C [23° to 104°F])	
Degree of protection	IP00	IP54

Current Consumption	
24V AC/DC	40mA AC, 25mA DC
110VAC	30mA AC

Dimensions mm [in]

DR22B8-EB

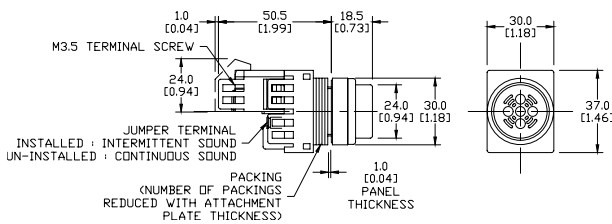

DR22B8-HB

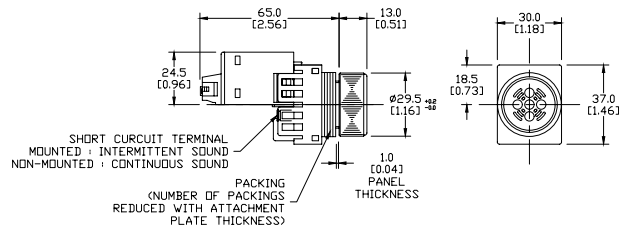

DR22B5-EB

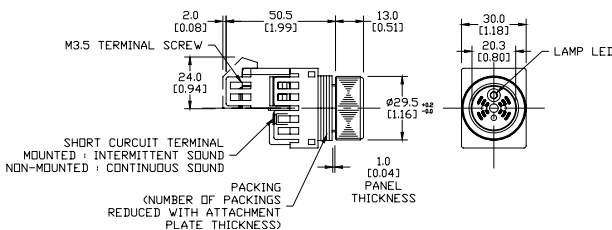

DR22B5-HB

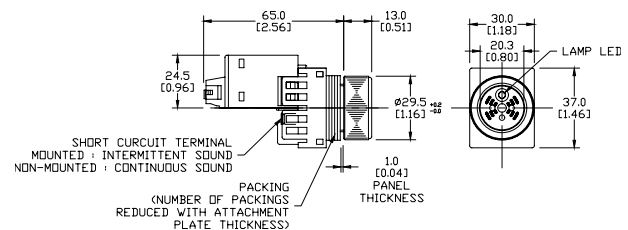

Please see our website www.AutomationDirect.com for complete engineering drawings. Dimensions are approximate. Not for construction purposes.

Fuji Electric Command Series 22mm Pilot Devices Specifications

Specifications (indoor use)			
	Pushbuttons Emergency stop pushbuttons Selector switches	Joysticks	Pilot Lights
Rated thermal current (contact block)	A600 / P600	-	-
Mechanical durability	See durability table below	250,000 operations	-
Electrical durability	500,000 operations at 220V AC 6A 1 million operations at 220V AC 3A	100,000 operations at 220V AC 1A (Res. load)	-
Operating frequency	1200 operations/hour (On-load factor: 40%)		-
Operating force (Avg)	9N – Pushbuttons 30-45 N – Emergency stop pushbuttons 0.15 - 0.1 N-m – Selector switches	Less than 100N	
Positive opening operation	All functions incorporating a N.C. contact are positive-opening operation.		
Dielectric strength	2,500VAC, 1 minute (w/o transformer 2000VAC)	2000VAC, 1 minute (Pilot light with transformer: 2500 VAC, 1minute)	
Insulation resistance	100MΩ or more (500VDC megger)		
Rated impulse dielectric strength	6kV	-	6kV
Conditional short-circuit current	1000A		-
Short-circuit protective device	Fuse 15A (recommended, not supplied)	Fuse 1A (recommended, not supplied)	-
Pollution degree	3		
Vibration	Resonance: 10 to 55Hz, double amplitude 0.1 mm* / Constant: 16.7 Hz, double amplitude 3mm		
Shock	Malfunction durability: 100 m/s ² ** /	Mechanical durability: 500 m/s ²	Mechanical durability: 500 m/s ²
Ambient temperature (no condensation or no icing)	-20° to +70°C [-4° to +158°F] Illuminated type: -20° to -50°C [-4° to -58°F]	-5° to +60°C [+23° to +140°F]	-20° to +50°C [-4° to +122°F]
Temperature ratings	Storage: -40° to +80°C [-40° to +176°F]		
Humidity	45 to 85% RH (within -5° to +40°C)		
Degree of protection	IP65		
Initial contact resistance	≤ 50mΩ	-	-
Terminal markings	IEC 60445	-	-
Connections	AWG 18 to AWG 14; Stripping length: 8mm to 11mm / Tightening torque: 0.8 to 1.0 N-m, 7.1 in-lb to 8.8 in-lb		
Contacts operation	Self-cleaning types. Slow action. Positive opening.		
Operation frequency	1,200 cycle/hour (Application ratio 40%)	-	-
Utilization category/contact ratings	AC-15: 24VAC at 6A, 110VAC at 6A DC-13: 24VDC at 4A, 110VDC at 1.3 A	AC-1: 110VAC at 0.3 A DC-13: 24VDC at 0.7 A, 110VDC at 0.15 A	-
Rated insulation voltage	600V AC/DC***	250V AC/DC	250V AC/DC (w/transformer 600VAC)
Materials	Enclosure: Polyamide / Contacts: silver, nickel		
Standards	UL 508, CSA C22.2, No.14, TUV - EN60947-5-1		
Approvals	UL file E44592, CSA file LR20479		

* Emergency stop type: 10 to 500 Hz, double amplitude 0.7mm(acceleration 50m/s²), according to test condition of EN60947-5-5 (1998)

** Emergency stop type: 150 m/s²

*** Illuminated type without transformer

To obtain the most current agency approval information, see the Agency Approval Checklist section on the specific part number's web page.

Mechanical Durability		
		Operations
Pushbutton switch Illuminated pushbutton switch E-stop pushbutton switch E-stop illuminated pushbutton	Momentary action	5 million
	Alternate action	1 million
	Push-lock, turn-reset	100,000
	Push-lock, pull-reset	30,000
Selector switch	Maintained 1, 2, 3, 4-contact	1 million
	Maintained 5, 6-contact	500,000
	Spring return, spring/manual return	200,000
Illuminated selector switch	Maintained	
	Without transformer 1, 2, 3-contact	1 million
	4-contact	500,000
	With transformer 1, 2-contact	1 million
	3-contact	500,000
Spring return, spring/manual return	200,000	

Note: Key insertion/removal durability for selector switch key types

• Key type 10,000

22mm Pilot Devices Cutouts

AR22 pilot devices can be mounted in either 22.3 or 25.5 mm diameter holes as shown in the figure below without any extra adapter.

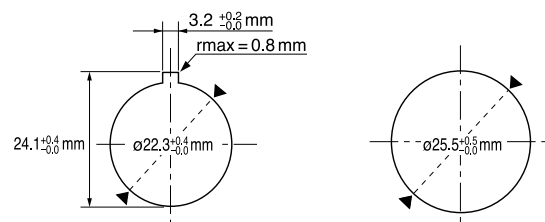

Note: If key washer or legend plate is not used, 3.2 mm-wide location holes do not need to be cut out.

Fuji Electric 22mm Pilot Devices Overview

Pushbuttons, Selectors, Pilot Lights, Joysticks, Buzzers

Fuji Electric AR22 pilot devices can be mounted on panels up to 6mm thick by securing the operator with a locking nut from behind the panel without needing any adjustment.

Easy mounting

Fuji AR22 pilot devices can be mounted on panels between 1 and 6mm thick and are mountable in panel cutouts of 22.3 or 25.5 mm. The button and lens can be mounted on a panel while the operator is engaged.

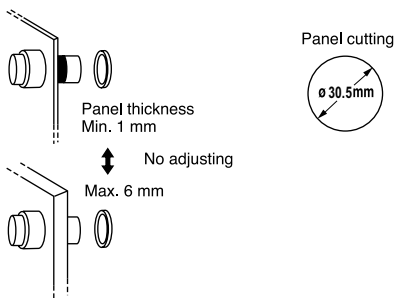

Wiring

These pilot devices can be wired in both vertical and lateral directions making wiring in narrow spaces easier. Contact block color coding makes wiring even easier.

1NO: Blue, 1NC: Red

Lamp terminal and transformer unit: black

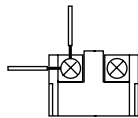

Short depth

Fuji AR22 pilot devices are designed to occupy less space than traditional 22mm devices.



AR22FOR-01RZA



AR22FOL-10E3YZA



DR22E3L-E3SZA



AR22VOR-01R



AR22PR-210BZA



DR22B8-EB

Quick contact block and transformer replacement

Fuji AR22 pilot devices have a snap-on mounting that makes replacing or adding a contact block and transformer unit easier.

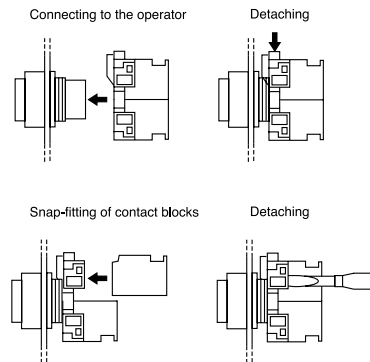

Safety

AR22 pilot devices include terminal covers for added safety and security. Emergency stop pushbuttons include a trigger action mechanism that prevents the contacts from moving until the button is pushed and locked.

Protection

AR22 pilot devices feature oil and dust-tight operator construction (IP65), except for buzzers DR22B5 (IP00), DR22B8 (IP54).

