

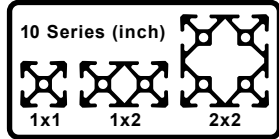

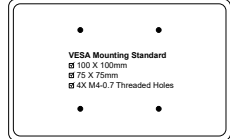

FATH® T-Slotted Rail Accessories

Monitor Mounts





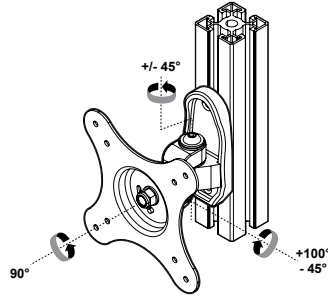
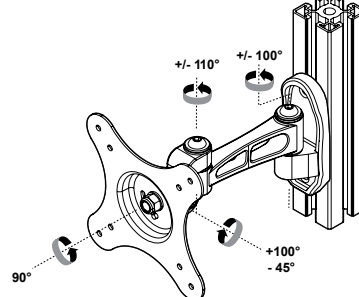
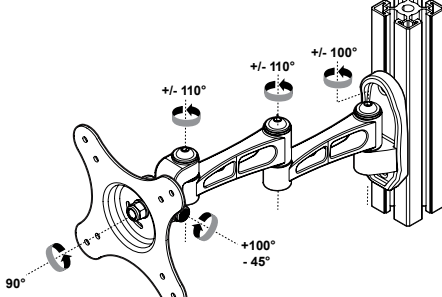





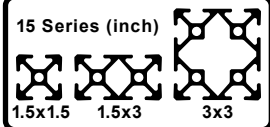

10 Series Monitor Mounts							
<ul style="list-style-type: none"> Fits monitors with VESA mounting standard Durable steel construction Powder coat finish Mounting hardware included for several mounting locations 		Fits  Slot Size 6					
Part Number	Part Image	Price	Description	Load Rating kg [lb]	Pack Quantity	Installation Instructions Link	Drawing Link
162893		\$42.00	Swivel Monitor Mount	15 [33.1]	1	PDF	PDF
162894		\$50.00				PDF	PDF
162895		\$58.00				PDF	PDF

Monitor Mounts Adjustments		
 <p>162893</p>	 <p>162894</p>	 <p>162895</p>

FATH® T-Slotted Rail Accessories

Monitor Mounts



15 Series Monitor Mounts							
<ul style="list-style-type: none"> Fits monitors with VESA mounting standard Durable steel construction Mounting hardware included for several mounting locations 		Fits  Slot Size 8					
Part Number	Part Image	Price	Description	Load Rating kg [lb]	Pack Quantity	Installation Instructions Link	Drawing Link
162893		\$42.00	Swivel Monitor Mount	15 [33.1]	1	PDF	PDF
162894		\$50.00				PDF	PDF
162895		\$58.00				PDF	PDF
162896		\$92.00	Monitor Mounting Joint			PDF	PDF
162897		\$92.00	Monitor Holder			PDF	PDF
162899		\$325.00	4-Axis Mounting Support	10 [22.0]		PDF	PDF
162900		\$375.00	5-Axis Mounting Support			PDF	PDF
162901		\$600.00	4-Axis Workstation	8 [17.6]	PDF	PDF	

FATH® T-Slotted Rail Accessories

Workstation Components



15 Series Workstation Components

Fits Slot Size 8

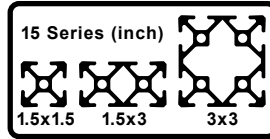

Part Number	Part Image	Price	Description	Load Rating kg [lb]	Pack Quantity	Material	Drawing Link
162902		\$185.00	Keyboard Holder (requires mounting solution, designer's choice)	n/a	1	Aluminum/nylon	PDF
162906		\$8.00	Magnetic Holder			Nylon/steel	PDF
162964		\$9.00	Grab Tray			Nylon	PDF
162965		\$2.00	Label Clip			PVC	PDF

Workstation Components Installation

Keyboard Holder (mounting example)

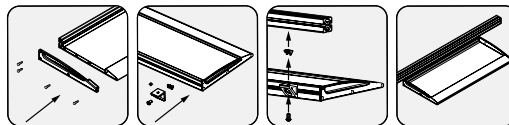

Magnetic Holder

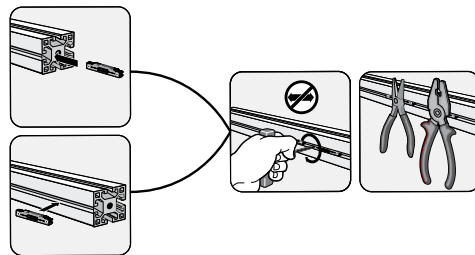

Grab Tray

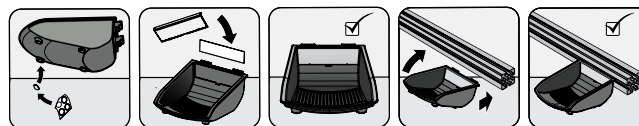

Label Clip

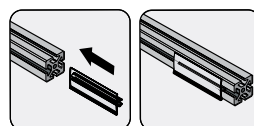

FATH® T-Slotted Rail Accessories

Monitor Mounts







30 Series Monitor Mounts							
<ul style="list-style-type: none"> Fits monitors with VESA mounting standard Durable steel construction Powder coat finish Mounting hardware included for several mounting locations 		Fits Slot Size 8					
Part Number	Part Image	Price	Description	Load Rating kg [lb]	Pack Quantity	Installation Instructions Link	Drawing Link
162893		\$42.00	Swivel Monitor Mount	15 [33.1]	1	PDF	PDF
162894		\$50.00				PDF	PDF
162895		\$58.00				PDF	PDF

Monitor Mounts Adjustments		
<p>162893</p>	<p>162894</p>	<p>162895</p>

FATH® T-Slotted Rail Accessories

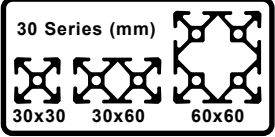
Workstation Components



30 Series Workstation Components							
		Fits  Slot Size 8					
Part Number	Part Image	Price	Description	Load Rating kg [lb]	Pack Quantity	Material	Drawing Link
162902		\$185.00	Keyboard Holder	n/a	1	Aluminum/nylon	PDF
162964		\$9.00	Grab Tray			Nylon	PDF
162965		\$2.00	Label Clip			PVC	PDF

Workstation Components Installation

Keyboard Holder (mounting example)

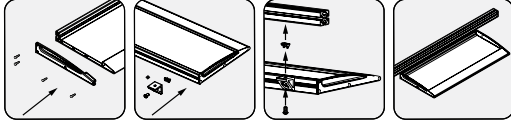

Grab Tray





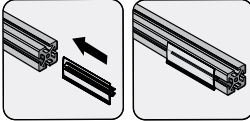





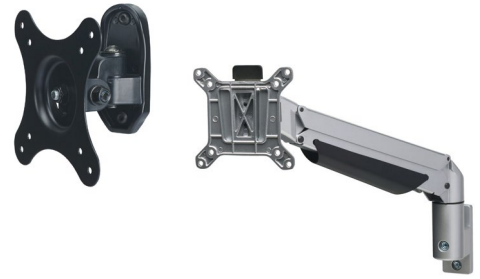

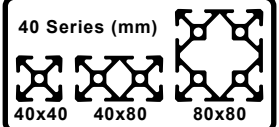

Label Clip



FATH® T-Slotted Rail Accessories

Monitor Mounts







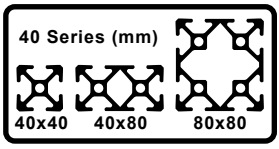

40 Series Monitor Mounts							
<ul style="list-style-type: none"> Fits monitors with VESA mounting standard Durable steel construction Mounting hardware included for several mounting locations 		Fits  Slot Size 8					
Part Number	Part Image	Price	Description	Load Rating kg [lb]	Pack Quantity	Installation Instructions Link	Drawing Link
162893		\$42.00	Swivel Monitor Mount	15 [33.1]	1	PDF	PDF
162894		\$50.00				PDF	PDF
162895		\$58.00				PDF	PDF
162896		\$92.00	Monitor Mounting Joint			PDF	PDF
162897		\$92.00	Monitor Holder			PDF	PDF
162899		\$325.00	4-Axis Mounting Support	10 [22.0]		PDF	PDF
162900		\$375.00	5-Axis Mounting Support			PDF	PDF
162901		\$600.00	4-Axis Workstation	8 [17.6]	PDF	PDF	

FATH® T-Slotted Rail Accessories

Workstation Components



40 Series Workstation Components							
		Fits  Slot Size 8					
Part Number	Part Image	Price	Description	Load Rating kg [lb]	Pack Quantity	Material	Drawing Link
162902		\$185.00	Keyboard Holder (requires mounting solution, designer's choice)	n/a	1	Aluminum/nylon	PDF
162906		\$8.00	Magnetic Holder			Nylon/steel	PDF
162909		\$5.25	Top Angle Clamp			Nylon/steel	PDF
162964		\$9.00	Grab Tray			Nylon	PDF
162965		\$2.00	Label Clip			PVC	PDF

Workstation Components Installation

Keyboard Holder (mounting example)

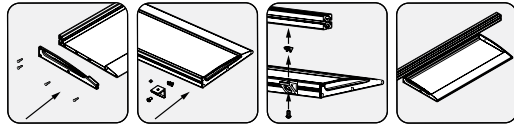

Magnetic Holder

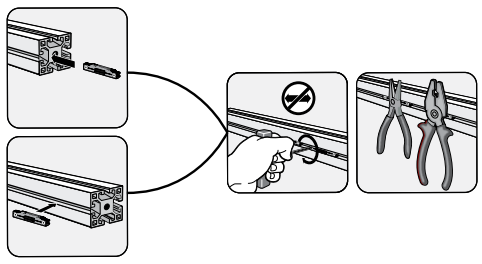

Grab Tray

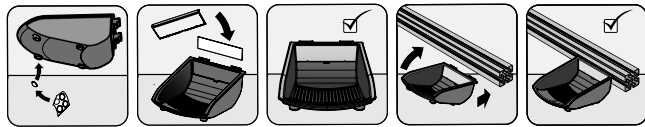



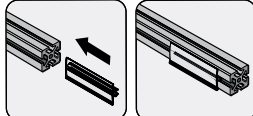





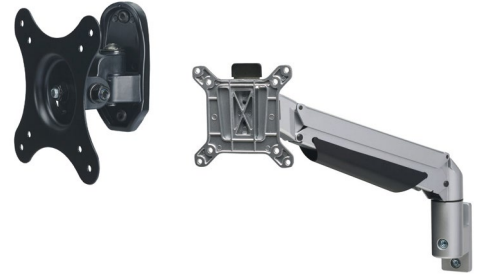

Label Clip

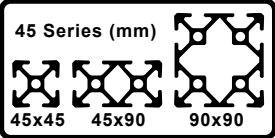
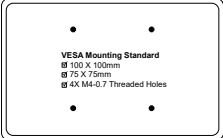

FATH® T-Slotted Rail Accessories

Monitor Mounts



45 Series Monitor Mounts							
<ul style="list-style-type: none"> Fits monitors with VESA mounting standard Durable steel construction Powder coat finish Mounting hardware included for several mounting locations 		Fits  Slot Size 10					
Part Number	Part Image	Price	Description	Load Rating kg [lb]	Pack Quantity	Installation Instructions Link	Drawing Link
162893		\$42.00	Swivel Monitor Mount	15 [33.1]	1	PDF	PDF
162894		\$50.00				PDF	PDF
162895		\$58.00				PDF	PDF
162896		\$92.00	Monitor Mounting Joint			PDF	PDF
162898		\$93.00	Monitor Holder			PDF	PDF
162899		\$325.00	4-Axis Mounting Support	10 [22.0]		PDF	PDF
162900		\$375.00	5-Axis Mounting Support			PDF	PDF
162901		\$600.00	4-Axis Workstation	8 [17.6]	PDF	PDF	

FATH® T-Slotted Rail Accessories

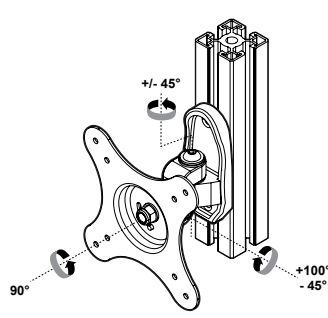
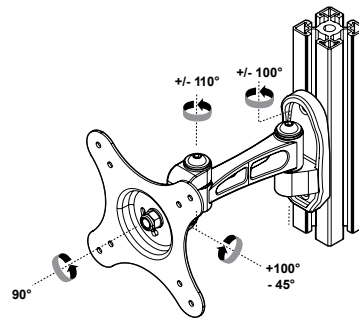
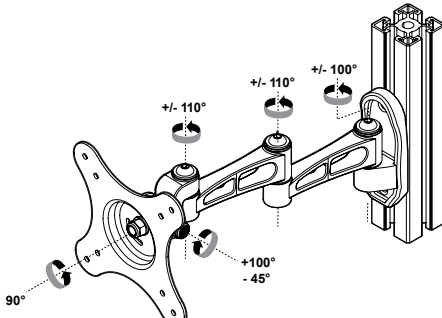
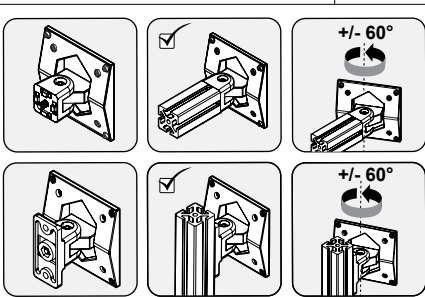
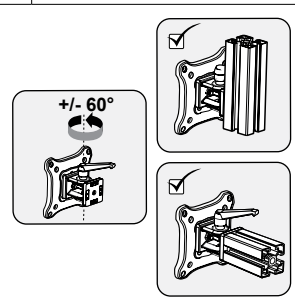
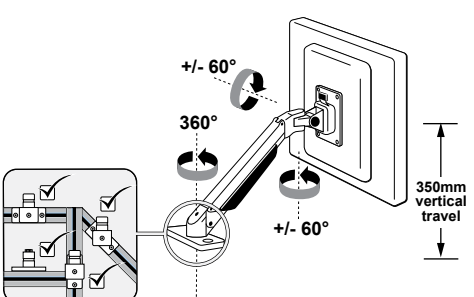
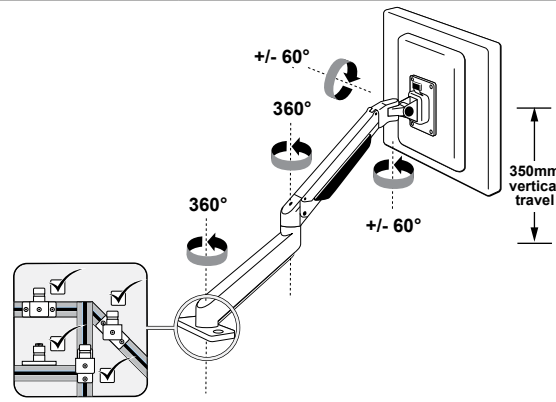
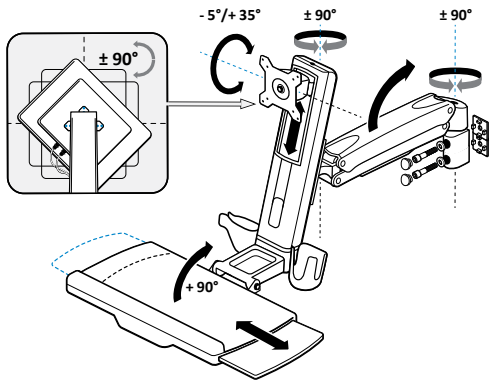

Monitor Mounts - Continued

Monitor Mounts Adjustments		
 <p>162893</p>	 <p>162894</p>	 <p>162895</p>
 <p>162896</p>	 <p>162898</p>	
 <p>162899</p>	 <p>162900</p>	
 <p>162901</p>		

FATH® T-Slotted Rail Accessories

Workstation Components

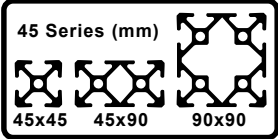

45 Series Workstation Components							
		Fits  Slot Size 10					
Part Number	Part Image	Price	Description	Load Rating kg [lb]	Pack Quantity	Material	Drawing Link
162902		\$185.00	Keyboard Holder (requires mounting solution, designer's choice)	n/a	1	Aluminum/nylon	PDF
162966		\$2.25	Label Clip		10	PVC	PDF

Workstation Components Installation

Keyboard Holder (mounting example)

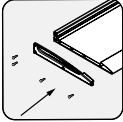

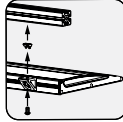
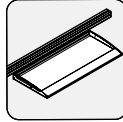
Label Clip

