

Dual Element Time-Delay Class J Fuses



EDISON JDL Class J fuses are among the most popular current limiting time-delay fuses available. Their small physical size and high performance characteristics make Class J fuses ideal for any space-limited application.

Specifications

- Voltage Rating: JDL - 600 VAC
- Ampere Rating: 1–600 Amps
- Interrupting Rating: 200,000 RMS Symmetrical Amps
- Self-Certified Interrupting Rating: 300,000 RMS Symmetrical Amps
- Self-Certified DC Ratings:
 - Voltage Rating: JDL - 300 VDC
 - Interrupting Rating: JDL - 20,000 Amperes DC
- Current Limiting:
 - Class J Fuse

JDL Features

- Space saving dimensions compared to Class R
- Dual-Element construction provides superior time-delay to pass harmless motor or transformer surges
- High performance with fatigue-free cycling capabilities
- Extremely current limiting

Applications

- Recommended for Type 2 (no damage) protection of IEC style motor starters and contactors.
- Use to protect lower interrupting rated circuit breakers.
- All general purpose circuits with inductive (high inrush) loads, including motor and motor branch circuits, and transformer circuits. Also suitable for lighting loads.

Agency Approvals

- UL Listed, Class J, Guide JDDZ, File E162363
- CSA Certified HRCI-J per C22.2, No. 248.8

JDL Series Dual-element Time-delay Fuses					
Part Number	AMP Rating	Rated Voltage AC Max	Pcs/ Pkg	Package Weight	Price
JDL1	1	600V	10	1.00 lb.	\$273.00
JDL2	2				\$273.00
JDL3	3				\$280.00
JDL4	4				\$291.00
JDL5	5				\$270.00
JDL6	6				\$272.00
JDL8	8				\$284.00
JDL10	10				\$271.00
JDL12	12				\$269.00
JDL15	15				\$286.00
JDL17-5	17.5		\$296.00		
JDL20	20		\$284.00		
JDL25	25		\$287.00		
JDL30	30		\$312.00		
JDL35	35		\$491.00		
JDL40	40		\$481.00		
JDL45	45		\$489.00		
JDL50	50		\$478.00		
JDL60	60		\$483.00		
JDL70	70		5	1.70 lb	\$451.00
JDL80	80				\$451.00
JDL90	90				\$478.00
JDL100	100				\$452.00
JDL110	110				\$184.00
JDL125	125		1	4.25 lb	\$181.00
JDL150	150				\$184.00
JDL175	175				\$184.00
JDL200	200				\$184.00
JDL225	225				\$294.00
JDL250	250			1.70 lb	\$286.00
JDL300	300	\$340.00			
JDL350	350	\$344.00			
JDL400	400	\$312.00			
JDL450	450	2.80 lb			\$508.00
JDL500	500		\$512.00		
JDL600	600		\$489.00		

CROSS REFERENCE				
VOLTS	EDISON	BUSSMANN	MERSEN GOLD	LITTELFUSE
600	JDL	LPJ	AJT	JTD

JDL Dimensions inches (mm)

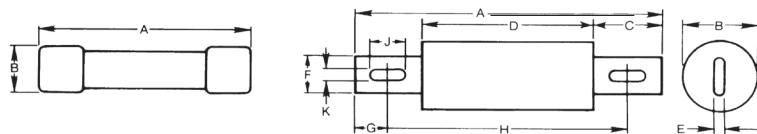

JDL Series Dimensions - Inches [mm]										
Ampere Rating	Overall Length	Max. Dia.	Blade Length	Barrel Length	Blade Thickness	Blade Width	Mounting Hole Spacing			
Range	A	B	C	D	E	F	G	H	J	K
1-30	2.25 [57.15]	0.81 [20.6]	-	-	-	-	-	-	-	-
35-60	2.38 [60.5]	1.06 [26.92]	-	-	-	-	-	-	-	-
70-100	4.63 [117.5]	1.13 [28.6]	1 [25.4]	2.63 [66.7]	0.13 [3.2]	0.75 [19.1]	0.5 [12.7]	3.63 [92.1]	0.38 [9.5]	0.28 [7.1]
110-200	5.75 [146.1]	1.63 [41.3]	1.38 [34.9]	3 [76.2]	0.19 [4.8]	1.13 [28.6]	0.69 [17.5]	4.38 [111.1]	0.38 [9.5]	0.28 [7.1]
225-400	7.13 [181]	2.13 [54]	1.88 [47.8]	3.38 [85.8]	0.25 [6.35]	1.63 [41.3]	0.94 [23.8]	5.25 [133.4]	0.56 [14.3]	0.41 [10.3]
450-600	8 [203.2]	2.5 [63.5]	2.13 [54]	3.75 [95.3]	0.38 [9.5]	2 [50.8]	1 [25.4]	6 [152.4]	0.75 [19.1]	0.53 [13.5]

Dual Element Time-Delay Class J Fuses



AVERAGE TIME/CURRENT CURVE

Cat. No. JDL (Amp) 600V

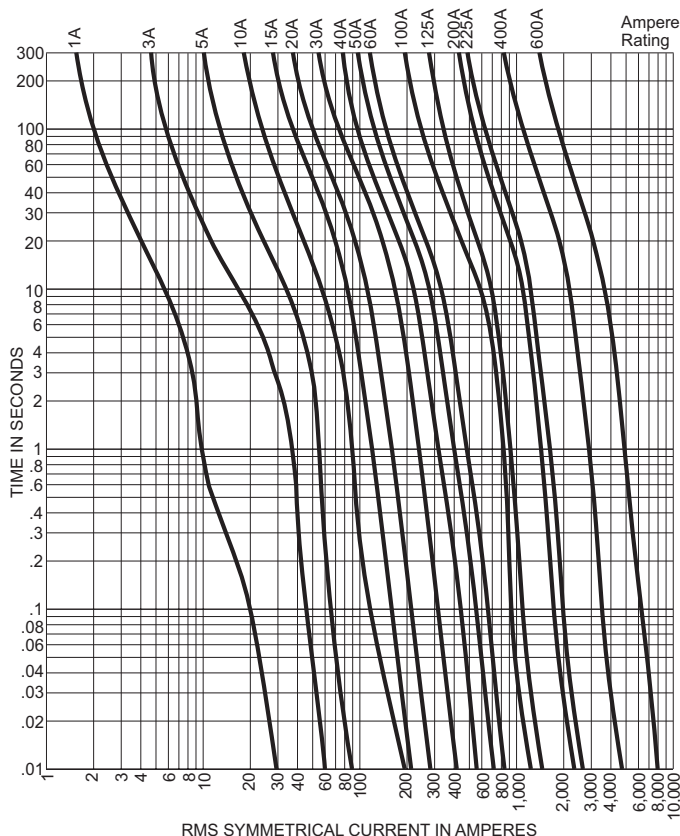

PEAK LET-THROUGH CURRENT CURVES

Cat. No. JDL (Amp) 600V

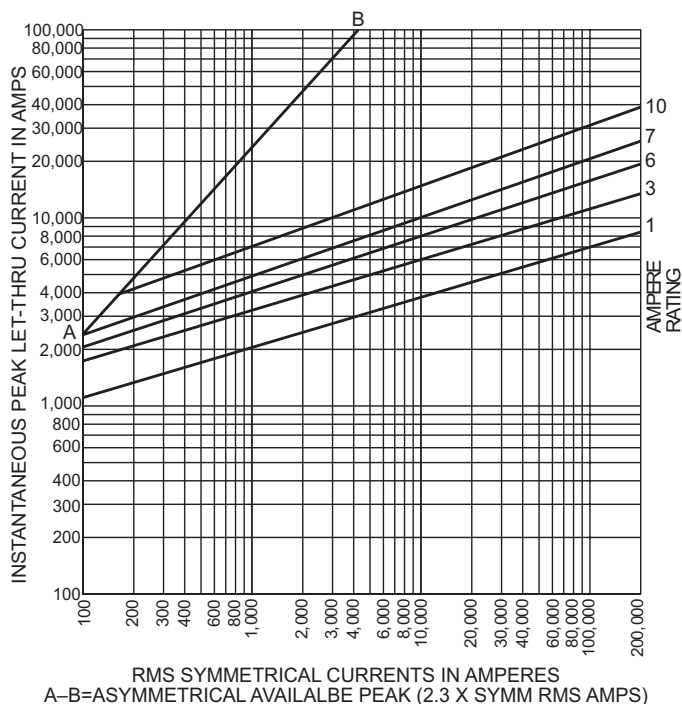

Current-Limiting Effects

*Prop. S.C.C.	Let-Thru Current (Apparent RMS Symmetrical) JDL (600V) Fuse Ratings						
	15A	30A	60A	100A	200A	400A	600A
1,000	270	470	750	—	—	—	—±
3,000	370	670	1,130	1,640	2,360	—	—
5,000	450	800	1,420	1,910	2,760	4,400	—
10,000	550	1,000	1,730	2,450	3,520	5,540	8,000
15,000	625	1,220	1,890	2,850	4,000	6,420	9,000
20,000	700	1,330	2,120	3,090	4,400	7,000	10,000
25,000	750	1,440	2,250	3,400	5,000	7,500	11,100
30,000	800	1,530	2,370	3,650	5,140	8,000	11,800
35,000	820	1,600	2,580	3,780	5,430	8,330	12,500
40,000	900	1,640	2,670	4,000	5,640	9,000	13,270
50,000	925	1,760	2,790	4,470	6,000	9,380	13,820
60,000	1,000	1,850	3,000	4,670	6,420	10,000	15,000
80,000	1,160	2,000	3,220	5,000	7,400	11,270	16,000
100,000	1,220	2,150	3,520	5,360	7,950	12,180	17,270
150,000	1,400	2,460	4,000	6,170	9,000	14,360	19,270
200,000	1,560	2,640	4,450	7,000	10,000	15,820	20,600

*RMS Symmetrical Amperes Short-Circuit Current.

NOTE Data derived from Current Limiting Curves.

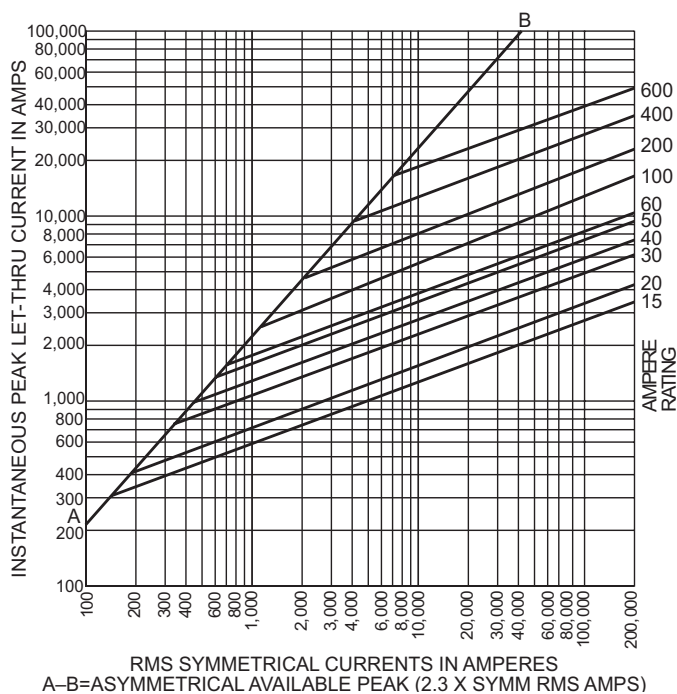



Selection Guide

Line Overview

The Edison family of fuses, fuse blocks and fuse holders is divided into two classes:

1. Current Limiting: Class CC, Class J, Class L, Class RK, Class T
2. General Purpose: Class M Midget and Small Dimension

The fuse selection guide below is a general summary of the

specifications included for each fuse type. This selection guide does not include the many variables that can exist for specific situations such as local codes, unusual temperature, or other operating conditions. When selecting fuses, be sure to comply with any applicable PUBLIC SAFETY standards that apply to Overcurrent Protection Devices (OPD).

Edison Fuses Selection Guide and General Specifications												
Description	Current Limiting											
	Class J		Class RK5		Class RK1		Class T		Class L	Class CC		
Fuse Type	Fast-Acting	Time-Delay	Time-Delay				Extremely Fast-Acting	Fast-Acting	Fast-Acting	Time-Delay		
Part Number	JHL	JDL	ECNR	ECSR	LENRK	LESRK	TJN	TJS	LCU	HCLR	HCTR	EDCC
Voltage Rating	600VAC 450VDC	600VAC 300VDC*	250VAC 125 VDC* (1-200A) 250VDC* (201-600A)	600VAC 300VDC*	250VAC 125 VDC* (10-60A) 250VDC* (70-600A)	600VAC 300VDC*	300VAC 160 VDC (15-600A)	600VAC	600V	600VAC 300VDC (15-20A)	600VAC	600VAC 300VDC (0.5-2.25A) (20-30A)
Amp Rating	1 - 600		1 - 600	3 - 600	10 - 600	5 - 600	1 - 600		601 - 1200	0.5 - 30	0.25 - 30	0.5 - 30
Interrupting Rating	200,000 RMS Symmetrical Amps											
Current Limiting	Class J		Class RK5		Class RK1		Class T		Class L	Class CC		
Agency Approvals	UL Listed Class J Guide JDDZ File E162363 CSA Certified HRCI-J per C22.2, No. 248.8 File 700489 RoHS compliant	UL Listed Class J Guide JDDZ File E162363 CSA Certified HRCI-J per C22.2, No. 248.8 File 700489	UL Listed, Class RK, Guide JDDZ, File E162363 CSA Certified HRCI-R per C22.2, No. 248.12, File 700489 (LENRK CSA File 053787)				UL Listed, Class T, Guide JDDZ, File E162363 CSA Certified HRCI-T per C22.2, No. 248.12, File 53787, Class 1422-02 & 1422-82		UL Listed, Std. 248-10 CSA Certified, HRC-L C22.2 No. 248.10, Class 1422-02, File 53787	UL Listed to 248.4, Class CC, Guide JDDZ, File E162363, CSA certified HRCI-MISC per C22.2 No. 248.4, File 700489		
Dimensions	See product specification pages.									ferrule (in): 13/32, length (in): 1-1/2		

* Self-certified DC ratings

Edison Fuses Selection Guide and General Specifications												
Description	General Purpose – Midget				General Purpose – Small Dimension Electronic							
	Fast-Acting		Time-Delay		Fast-Acting Ceramic	Fast-Acting Glass		Medium Time-Delay Glass	Time-Delay Ceramic	Time-Delay Glass	Fast-Acting Glass	Time-Delay Glass
Part Number	MCL	MOL	MEQ	MEN	ABC	AGC	GMA	GMC	MDA	MDL	S500	S506
Voltage Rating	600 VAC	250 VAC	500 VAC	250 VAC	250 VAC (0.5 to 30A) 125VDC: (0.5 to 30A)	250VAC: (0.1 to 10A) 32VAC: (15 to 30A)	250VAC (0.063 - 3A) 125VAC (4 - 15A)	250VAC (0.5 - 3A) 125VAC (4 - 10A)	250VAC 125VDC (20A)	250VAC: (0.0625 to 8A) 32VAC: (10 to 20A)	250VAC	250VAC
Amp Rating	0.5 to 50	0.5 to 30	0.25 to 30	0.5 to 30	0.5 to 30	0.10 to 30	0.063 to 15	0.5 to 10	0.5 to 20	0.0625 to 20	0.032 to 10	0.25 to 6.3
Interrupting Rating	100,000 RMS Amps	10,000 RMS Amps				See specifications table on product pages						
Current Limiting	N/A				N/A							
Agency Approvals	UL Listed to 248.14, File E162443 CSA Cert. C22.2 Part 59.2, LR 700489				UL Listed standard 248-14 UL Listed Guide and File nos. (ABC 0.25-20 A): (AGC 1/100-10 A) JDYX and E19180 UL Recognition Guide and File nos. (ABC 20-30A):(AGC 11-30) JDYX2 and E19180 CSA Certification Record No: 053787 C 000 and Class No: 1422 01 and 1422 30	Designed to UL/CSA 248-14 UL Listed, Guide JDYX, File E19180 63mA-6A UL Recognition, Guide JDYX2, File E19180, 7A-15A CSA Certified, File 053787_C_000, 63mA-6A Class 1422-01		UL Listed standard 248-14 UL Listed Card: MDA 2/10-20A, MDL 1/16-8A (Guide JDYX, File E19180 UL Recognized Card: MDA 25-30A MDL 9-30A (Guide JDYX2, File E19180) CSA Certification Card: MDA 2/10-15A (Class No. 1422-01)		UL Recognized Guide JDYX2, File E19180 Semko Approval VDE Approval BSI Approval IMQ Approval RoHS compliant		
	RoHS											
Dimensions	ferrule (in): 13/32 length (in): 1-1/2				1/4" x 1-1/4", (6.3mm x 32mm)		0.197" x 0.788" (5mm x 20mm)		1/4" x 1-1/4", (6.3mm x 32mm)		0.197" x 0.788" (5mm x 20mm)	

Modular Ferrule Fuse Blocks for Class J Fuses



Description

JM Series for use with Class J fuses JHL & JDL

Mounting

35mm DIN rail or panel mount

Specifications

Materials:

Base – Thermoplastic
 Terminals – Tin-plated copper brass
 Covers – Thermoplastic
 Screws and pressure plates – Zinc-plated steel

SCCR: 200kA

Flammability rating:

Blocks – UL 94V0, self-extinguishing
 Covers – UL 94HB, self-extinguishing

Operating and storage temp range:

Blocks – -40° to 120°C [-40° to 248°F]
 Covers – indicating -20° to 90°C [-4° to 194°F]
 non-indicating -40° to 120°C [-40° to 248°F]

Wire:

Cu – 75°/90°C [167°/194°F]
 Al – 75°C [167°F]
 Ring or Fork terminal to fit a #10-32 screw

Agency Approvals

Fuse Blocks

- UL® Listed E14853 - IZLT
- CSA® Certified 47235-6225-01
- CE
- RoHS Compliant
- Conflict mineral free
- REACH Compliant

Covers

- Covers are included in the overall UL Listing/Recognition and CSA Certification
- IP20 finger-safe
- RoHS compliant
- REACH Compliant



To obtain the most current agency approval information, see the Agency Approval Checklist section on the specific part number's web page.

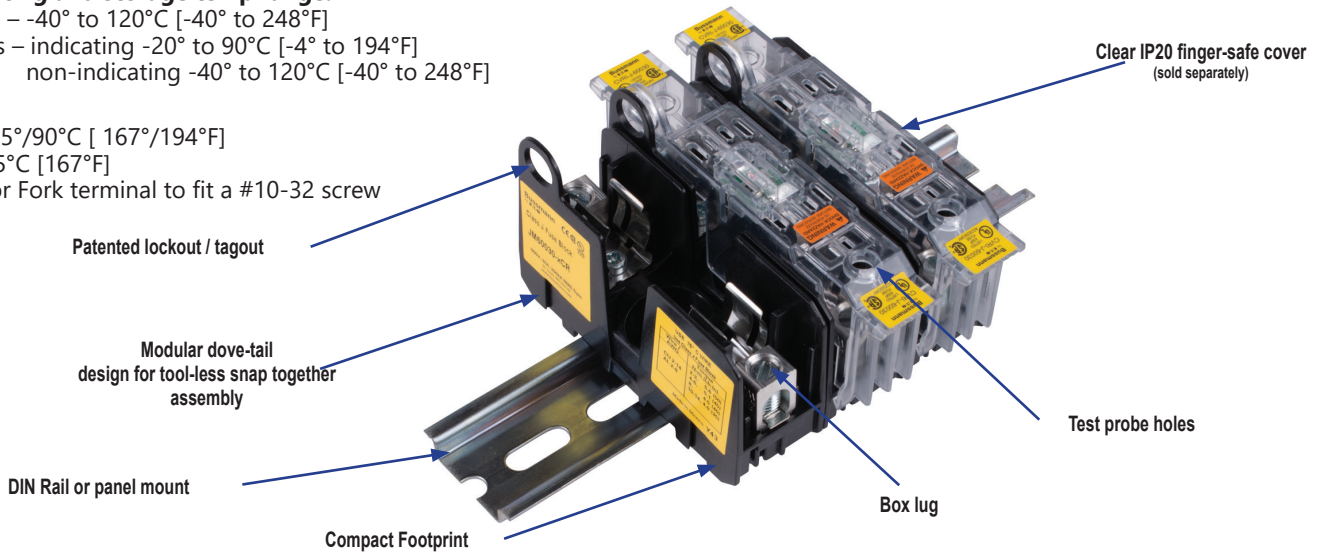

Modular Ferrule Fuse Blocks for Class J Fuses

Type	Part Number	Pc/ pkg	Price	Volts	Amps	Poles	Wire Range		Torque lb-in [N·m]	Wt. lb [kg]	Covers (sold separately)		Pc/ pkg		
							solid and stranded	fine stranded (Cu)			w/o Indication	w/ Indication ¹			
Box lug	JM60030-1CR	1	\$39.00	600V AC/DC	30	1	14-2 AWG (Cu) 8-2 AWG (Al)	3-2 AWG	50 [5.6]	0.15 [0.08]	CVR-J-60030 \$11.50	CVRI-J-60030 \$15.00	1		
	JM60030-2CR	1	\$82.00			2		6-4 AWG	45 [5.1]	0.25 [0.12]					
	JM60030-3CR	1	\$119.00			3		8AWG	40 [4.5]	0.40 [0.18]					
Pressure Plate	JM60030-1PR	1	\$35.50			1	18-10 AWG (Cu)	18-10 AWG	20 [2.3]	0.15 [0.08]					
	JM60030-2PR	1	\$70.00			2		0.25 [0.12]							
	JM60030-3PR	1	\$107.00			3		0.40 [0.18]							
Box lug	JM60060-1CR	1	\$47.50		60	3	14-2 AWG (Cu) 8-2 AWG (Al)	3-2 AWG	50 [5.6]	0.20 [0.10]	CVR-J-60060 \$14.00	CVRI-J-60060 \$15.50		1	
	JM60060-2CR	1	\$95.00					2	6-4 AWG	45 [5.1]					0.35 [0.16]
	JM60060-3CR	1	\$143.00					3	8AWG	40 [4.5]					0.55 [0.26]

¹ Open fuse indication requires 90V minimum and closed circuit to operate.



Modular Ferrule Fuse Blocks for Class J Fuses Dimensions

in [mm]

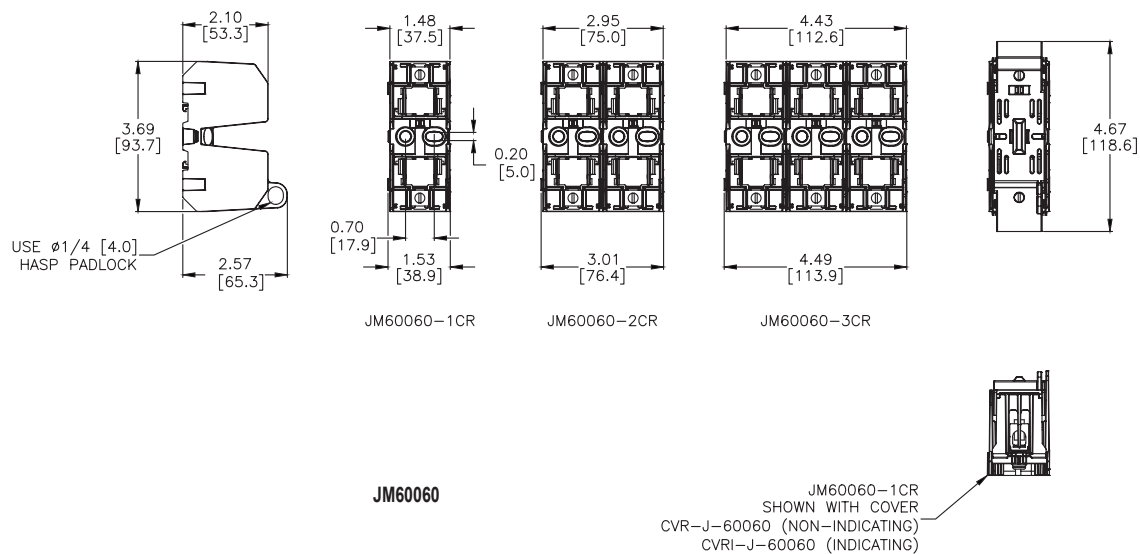
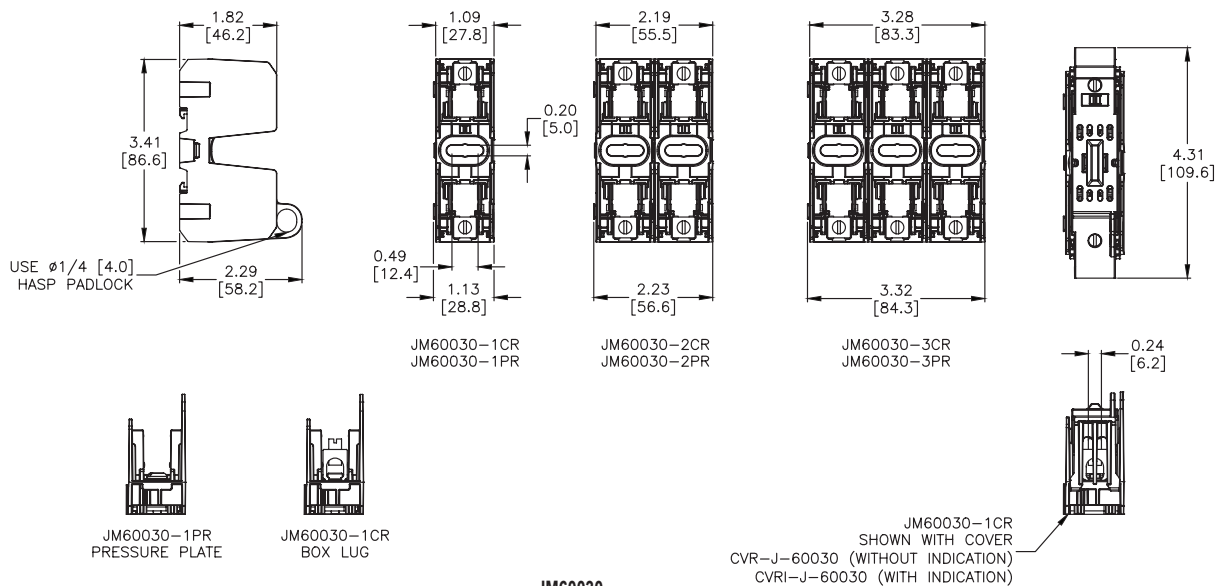

Please see our website www.AutomationDirect.com for complete engineering drawings. Dimensions are approximate. Not for construction purposes.

Modular Fuse Holders for Class J Fuses

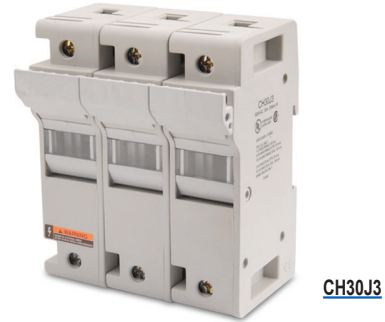

Description

- Choice of LED indicator or non-indicating fuse holder
- Comes in standard 1-, 2- and 3-Pole ganged assemblies where all fuses are extracted simultaneously
- Meets requirements of IEC 60529 for IP-20 finger safe rating
- 35mm DIN rail and chassis (6-32 UNC Pan Head recommended) mounting features
- Fuseholder wire ports dual wire rated from 18 to 3 AWG

Specifications

Construction: Thermoplastic, with tin-plated copper clip
 UL Flammability: 94V-0

Voltage Ratings: 600 Volts AC/DC (or less)

Ampere Ratings: 1 - 60 Amps

Interrupting Rating: 200,000 RMS Symmetrical Amps

Minimum Indicating Voltage (neon lamp): 90 Volts

Nominal Operating Current (neon lamp): 34 mA (460 VAC)

Agency Approvals

- Listed UL 512, Guide IZLT, File E14853
- CSA Certified per C22.2 Nos. 39 Class 6225-01, File LR47235
- CE compliance for the European Union Low Voltage Directive

CH Series Modular Fuse Holders for Class J Fuses								
Amp Rating	Part Number	Amps	Type	Poles	Maximum Wire Size	Pcs/Pkg	Weight (lbs.)	Price
30A	CH30J1	0.5 to 30	Easy ID window	1	18 -1 AWG Single 18 -3 AWG Dual 75°C	6	2.8	\$285.00
	CH30J2		Easy ID window	2		3		\$397.00
	CH30J3		Easy ID window	3		2		\$392.00
	CH30J1I		Neon indicator	1		6		\$330.00
	CH30J2I		Neon indicator	2		3		\$452.00
	CH30J3I		Neon indicator	3		2		\$430.00
60A	CH60J1	31 to 60	Easy ID window	1		6	3.4	\$380.00
	CH60J2		Easy ID window	2		3		\$445.00
	CH60J3		Easy ID window	3		2		\$451.00
	CH60J1I		Neon indicator	1		6		\$425.00
	CH60J2I		Neon indicator	2		3		\$529.00
	CH60J3I		Neon indicator	3		2		\$484.00

Dimensions

Dimension	CH30J in (mm)	CH60J in (mm)
A	1.28 (32.5)	1.58 (40.0)
B	2.56 (65.0)	3.16 (80.0)
C	3.84 (97.5)	4.72 (120.0)
D	4.59 (116.6)	4.88 (124.0)
E	2.83 (71.8)	3.31 (84.1)
F	3.56 (90.4)	3.85 (97.9)
G	1.28 (32.5)	1.58 (40.0)
H	0.18 (4.44)	0.18 (4.44)

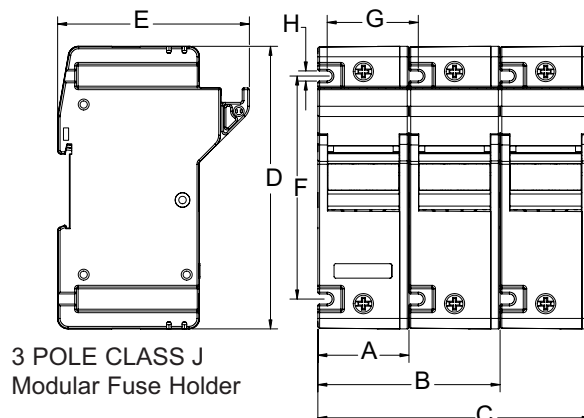

Accessories



FP-2

Accessories			
Part Number	Description	Pcs/Pkg	Price
FP-2	Fuse puller for fuse dia. 13/32" - 13/16". Fuse type: 0-60A, 250V; 0-30A, 600V	1	\$40.00
JV-L* <i>(Not Field Installable)</i>	Multi-pole connection kit to connect new design multiple Class CC and Midget Class fuse holders together. Kit consists of 6 connectors and 3 handle pins to connect up to 4 fuse holders.		\$15.00

Note: Will not work with retired design fuse holders shipped before November 1, 2009.

**Roll pin punch or installation tool is required to install handle pins (Tool not sold by AutomationDirect.com).*

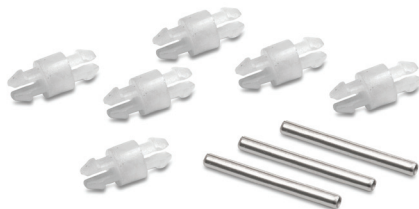

JV-L

Handle Pin Dimensions
 Diameter = 0.0625 in [1.58 mm]
 Length = 0.632 in [16.07 mm]

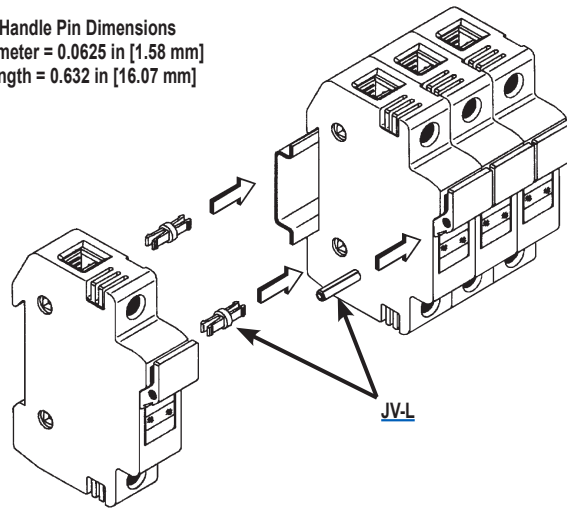

Cross Reference Guide



CROSS REFERENCE GUIDE By manufacturers type reference or series number. Ampere ratings must be added for ordering purposes.

FUSE TYPE		VOLT	EDISON	BRUSH/ DORMAN	BUSSMANN	MERSEN / GOULD	GEC/CEFCO	LITTELFUSE
UL CLASS CURRENT LIMITING FUSES (CSA CLASS)								
CC (HRCI-CC)	<i>Time-Delay</i>	600	EDCC	-	LP-CC	ATDR	-	CCMR
	<i>Time-Delay</i>	600	HCTR	-	FNQ-R	ATQR	-	KLDR
	<i>Fast-Acting</i>	600	HCLR	HCLR	KTK-R	ATMR	CTK-R	KLKR
RK1	<i>Time-Delay Dual Element</i>	250	LENRK	-	LPN-RK-SP	A2DR	-	LLNRK
		600	LESRK	-	LPS-RK-SP	A6DR	-	LLSRK
RK5	<i>Time-Delay Dual Element</i>	250	ECNR	-	FRN-R	TR	-	FLNR
		600	ECSR	-	FRS-R	TRS	-	FLSR
J	<i>Time-Delay Dual Element</i>	600	JDL	-	LPJ	AJT	-	JTD
	<i>High-Speed AC Drive</i>	600	JHL	-	DFJ	HSJ	-	-
T	<i>Extremely Fast-Acting</i>	300	TJN	-	JJN	A3T	-	JLLN
		600	TJS	-	JJS	A6T	-	JLLS
UL CLASS GENERAL PURPOSE FUSES								
Midget	<i>Fast-Acting</i>	600	MCL	MCL	KTK	ATM	CTK	KLK
		250	MOL	MOL	BAF/BAN	OTM	-	BLF
	<i>Time-Delay</i>	500	MEQ	MEQ	FNQ	ATQ	-	FLQ
		250	MEN	MEN	FNM	TRM	-	FLM
1/4"x 1-1/4" Ceramic	<i>Fast-Acting</i>	250/125	ABC	ABC	ABC	GAB	-	314
1/4"x 1-1/4" Glass		250/32	AGC	AGC	AGC	GGC	-	312
1/4"x 1-1/4" Ceramic	<i>Time-Delay</i>	250	MDA	MDA	MDA	-	-	326
1/4"x 1-1/4" Glass		250/32	MDL	MDL	MDL	GDL	-	313
5x20 mm Glass	<i>Fast-Acting</i>	250/125	GMA	GMA	GMA	GGM	-	235
	<i>Medium Time-Delay</i>	250/125	GMC	GMC	GMC	GSC	-	-
5x20 mm Glass	<i>Fast-Acting</i>	250	S500	BDB	GDB	GSB	-	217
	<i>Time-Delay</i>	250	S506	BDC	GDC	GDG	-	218
Fuse Puller								
Fuse Puller FP-2			old - 38072 new - FP-2	-	FP-2	-	-	-