

C-more Micro 6-inch TFT EA3 Touch Panel

Model [EA3-T6CL](#) **C-more** 6-inch Micro touch panel has a 5.7-inch TFT LCD 320 x 240 pixel display and a palette of 32K colors for customizing objects, screen backgrounds and displaying bitmap graphics. It features five user-defined function keys, each key with a user-defined red LED indicator. The **C-more** 6-inch Micro TFT panels are powered from a Class 2, 12-24 VDC power supply*. The panel is NEMA 4/4X indoor when installed correctly.

Part No. [EA3-T6CL](#)

Shown in Landscape (Horizontal) mode



*NOTE: Recommended DC power supply to power the **C-more** Micro Panel, AutomationDirect Part No. [PSL-24-010](#).

Features

- Touch screen display
- Free downloadable programming software
- 320 x 240 pixel display with up to 40 lines by 80 characters of text and graphics in landscape mode
- Up to 40 characters of dynamic text with embedded variables and phrases mixed with graphics
- Five programmable function keys can change with every screen. Can increment / decrement values, trigger recipes, view index of screens.
- 32K colors
- Optional replaceable clear screen overlay
- 6MB memory
- Supports Ethernet expansion module (EA-ECOM)
- Built-in USB type B programming port
- Built-in 15-pin serial communications port
- Built-in RJ12 serial communications port
- Built-in Alarm Control setup that activates beep, backlight flash, customized alarm banner, and red LED blinking
- 0 to 50 °C (32 to 122 °F) operating temperature range (IEC 60068-2-14)
- NEMA 4/4X, IP65 compliant when mounted correctly, indoor use only
- UL, cUL & CE agency approvals
- 2-year warranty from date of purchase

Function	Available
Ethernet	Optional (EA-ECOM)
USB Programming Port	Yes
Serial RJ12 Port	Yes
Serial DB15 Port	No



\$472.00



*NOTE: The EA3-T6CL can be powered through the USB port when connected to a PC for programming, the screen brightness is diminished because the panel is running in Low-Power Mode. For full brightness, connect an external Class 2, 12-24 VDC power source to the 6" panel's power connection. An external Class 2, 12-24 VDC power source must be used when the panel is installed in its application.

Dimensions

Units: inches [mm]

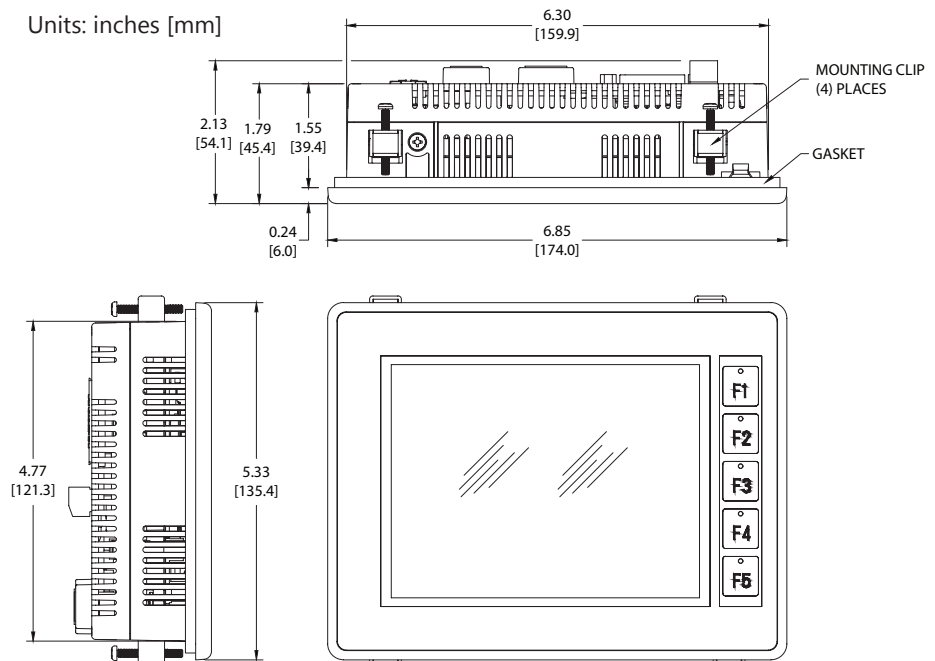

Panel Cutout

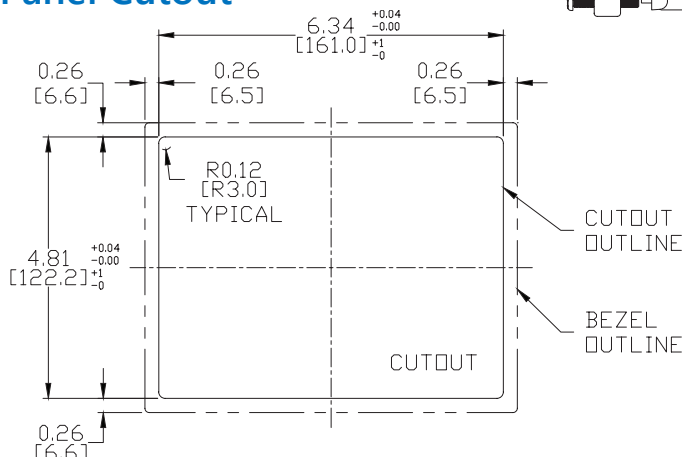

Panel Thickness

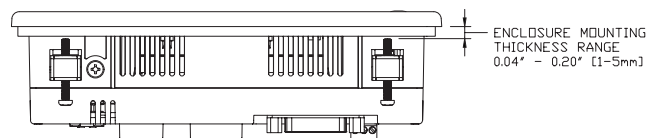

NOTE: The **C-more** 6-inch Micro cutout dimensions are not equivalent to previous AutomationDirect text panels. The **C-more** 6-inch Micro panels will not fit in cutouts for DV-1000, EZText, Optimate panels or **C-more** 6-inch panels.

C-more Micro EA3-T6CL Panel Specifications

EA3-T6CL Specifications	
Part Number:	EA3-T6CL
Description:	320 x 240 pixel LCD display (Landscape mode), Five user defined keypad function buttons with five user defined LED indicators
Display:	
• Type	5.7" TFT Graphical type with LED Backlight
• Resolution	320 (W) x 240 (H) pixel (Landscape Mode) 240 (W) x 320 (H) pixel (Portrait Mode)
• Color	32768 colors
• Display Brightness (Reference)	270 nits (typ)
• Viewing Area Size	4.57" (W) x 3.44" (H) [116.2 mm x 87.4 mm]
• Active Area Size	4.54" (W) x 3.40" (H) [115.2 mm x 86.4 mm]
• Contrast / Brightness	Adjusted from the panel's built-in configuration setup menu
• Viewing Angle (Landscape Mode)	3, 9 o'clock axis → 80 degrees 6 o'clock axis → 65 degrees 12 o'clock axis → 80 degrees
Backlight:	
• Type	LED
• Color	White
• User Replaceable	No
Touch Screen:	
• Type	Analog resistive, single touch*
• Operation	82 gram force [0.8 N] maximum
• Life	Minimum of 1,000,000 cycles
Features:	
• User Memory	6MB
• Number of Screens	Up to 999 – limited by project memory usage
• Beep (Internal)	Yes
• Keypad Function Buttons	Five user defined function key buttons with the ability to customize label with an overlay. Minimum of 500,000 cycles
• Keypad Function Button LEDs	Each function key button includes a red LED that can be user programmed.
• Programming Port	USB 2.0 Type B
• Serial Communications	RJ12 serial communications port (RS-232) 15-pin D-sub serial communications port (RS-232, RS-485 / 422).
• Ethernet Communications	10/100 Base-T (Automatic Negotiation) with EA-ECOM Module
Screen Objects	
• Functional Devices	Pushbutton, Switch, Indicator Button, Indicator Light, Graphic Indicator Light, Numeric Display, Numeric Entry, Inc/Dec Value, Bar Graph, Bitmap Button, Static Bitmap, Dynamic Bitmap, Recipe Button, Static Text, Lookup Text, Dynamic Text, Screen Change Pushbutton, Screen Selector, Adjust Contrast, Function, Key Configuration Object, Real Time Graphics Line Graph, Analog Meter.
• Static Shapes	Lines, Rectangles, Circles and Frames
• Displayable Fonts	Fixed fonts: 4x6, 6x6, 6x6B, 6x8, 8x16, 8x32, 8x64, 16x16, 16x32, 16x64, 32x16, 32x32, 32x64, and Windows fonts
*Note: The Touchscreen is designed to respond to a single touch. If it is touched at multiple points at the same time, an unexpected object may be activated.	
C-more Micro EA3-T6CL panel specifications continued on next page.	

C-more Micro EA3-T6CL Panel Specifications

EA3-T6CL Specifications (cont'd)	
Part Number:	EA3-T6CL
Electrical:	
• Input Power	10.2 - 26.4 VDC; Class 2 or SELV (Safety Extra-Low Voltage) or Limited Energy Circuit power supply 5VDC USB B-Port to PC
• Power Consumption	7.5 W (External power supply) 2.0 W (USB)
• Maximum Inrush Current	13A for 800µs
• Acceptable External Power Drop Duration	Maximum 1ms
Environmental:	
• Operating Temperature	0 to 50 °C (32 to 122 °F); Maximum surrounding air temperature rating: 50 °C (122 °F) IEC 60068-2-14 (Test Nb, Thermal Shock)
• Storage Temperature	-20 to +60 °C (-4 to +140 °F) IEC 60068-2-1 (Test Ab, Cold) IEC 60068-2-2 (Test Bb, Dry Heat) IEC 60068-2-14 (Test Na, Thermal Shock)
• Humidity	5-95% RH (non-condensing)
• Environmental Air	For use in Pollution Degree 2 environment, no corrosive gases permitted
• Housing Material	ABS Plastic
• Gasket Material	Silicone Rubber
• Overlay Sheet Material	PET
• Vibration	IIIEC60068-2-6 (Test Fc)
• Shock	IEC60068-2-27 (Test Ea)
• Altitude	Up to 2000m (6562ft)
• Noise Immunity	(EN61131-2) EN61000-4-2 (ESD), EN61000-4-3 (RFI) EN61000-4-4 (FTB) EN61000-4-5 (Serge) EN61000-4-6 (Conducted) EN61000-4-8 (Power frequency magnetic field immunity) (Local Test) RFI, (145MHz, 440Mhz 10W @ 10cm) Impulse 1000V @ 1µs pulse
• Enclosure	NEMA 250 type 4/4X indoor use only UL50 type 4X indoor use only IP-65 indoor use only (not tested by UL) (When mounted correctly)
• Agency Approvals	CE (EN61131-2), UL508, CUL Canadian C22.2 No. 142-M95, UL E157382, RoHS (2011/65/EU) To obtain the most current agency approval information, see the Agency Approval Checklist section on the specific part number's web page
Physical:	
• Enclosure Mounting Thickness Range	0.04" - 0.2" [1 - 5 mm]
• Mounting Clip Screw Torque Range	21 - 28 oz-in [0.15 - 0.20 Nm]
• Weight	21.1 oz. (600g)

C-more Micro EA3 Series PLC Drivers

PLC Drivers		
<i>Serial - port1 or port2</i>	<i>Serial - port2 only</i>	<i>Ethernet*</i>
AutomationDirect Productivity Series	Allen-Bradley DF1 Half Duplex	AutomationDirect Productivity Series Ethernet
AutomationDirect Do-more / BRX**	Allen-Bradley DF1 Full Duplex	AutomationDirect Do-more / BRX Ethernet
AutomationDirect CLICK	Allen-Bradley PLC5 DF1	AutomationDirect CLICK Ethernet
AutomationDirect K-sequence	Allen-Bradley DH485	AutomationDirect ECOM Ethernet
AutomationDirect DirectNET	GE SNPX (90/30, 90/70, Micro 90, VersaMax Micro)	Modbus TCP/IP
AutomationDirect Modbus (master only)	Mitsubishi FX	Allen-Bradley EtherNet/IP(Client) SLC5/05
Modicon Modbus RTU (master only)	Mitsubishi Q & QnA	Allen-Bradley EtherNet/IP(Client) ENI Adapter
Entivity Modbus RTU (master only)	Omron Host Link (C200 Adapter, C500)	Allen-Bradley EtherNet/IP(Client) MicroLogix 1100/1400
	Omron FINS Serial (CJ1, CS1)	Allen-Bradley EtherNet/IP (Client) Control/CompactLogix (SLC Mapping only)
	Siemens PPI (S7-200 CPU)	
	AutomationDirect SOLO Temperature Controller	
	AutomationDirect GS Drives	

* Ethernet port is built in to [EA3-S3ML](#) and [EA3-T4CL](#). [EA3-T6CL](#) requires the optional [EA-ECOM](#) module for Ethernet.
 Ethernet communications require external power supply.
 ** [BX-P-SER2-RJ12](#) is required

C-more Micro EA3 Series Power Connection Wiring

[EA3-S3ML-RN](#) and [EA3-S3ML-R](#)

- [EA3-S3ML-RN](#) and [EA3-S3ML-R](#) **C-more** Micro panels are powered during programming from the PC through the USB to RS-232 Programming Cable Assembly, [EA-MG-PGM-CBL](#).
- During operation, [EA3-S3ML-RN](#) and [EA3-S3ML-R](#) **C-more** Micro panels can be powered from most AutomationDirect PLC's RJ12 serial communications ports by using the [DV-1000CBL](#) communications cable.

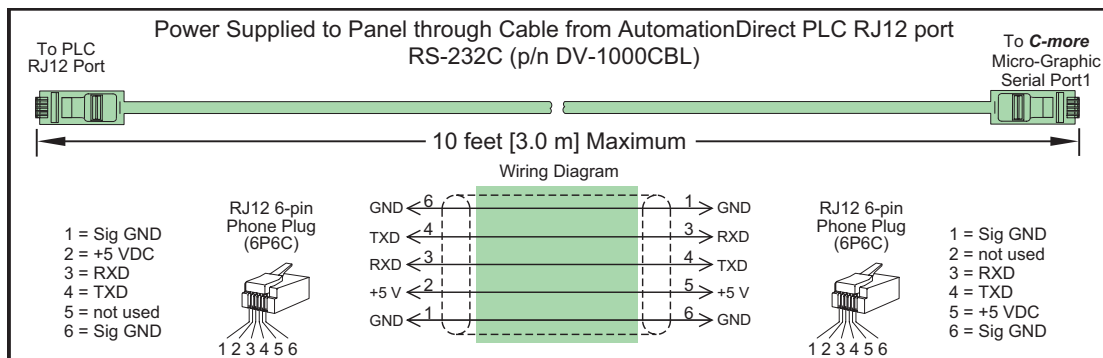

[EA3-S3ML](#), [EA3-T4CL](#) and [EA3-T6CL](#)

[EA3-S3ML](#), [EA3-T4CL](#) and [EA3-T6CL](#) **C-more** Micro EA3 series panels are powered by a Class 2, 2.5 Amp @ 12-24 VDC power source in normal operation.

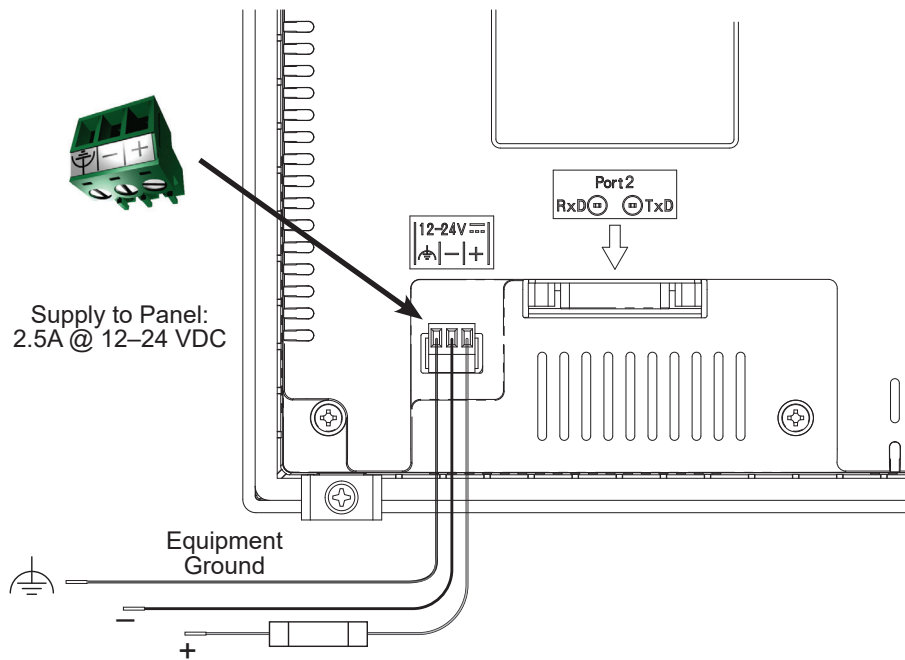

WARNING: USING A DIFFERENTIAL POWER SUPPLY AND CONNECTION THE USB TO A PC CAN DAMAGE BOTH THE PANEL AND THE PC.

C-more Micro EA3 Series PLC Connections

Cabling requirements

The table below describes the EA3 series cabling options available for most AutomationDirect PLCs.

EA3 Series Cabling Options			
Part Number	Port1 RJ12 (RS-232)	Port2 15-pin (RS-232) See PLC List A	Port2 15-pin (RS-232) See PLC List B
EA3-S3ML		EA-2CBL	EA-2CBL-1
EA3-S3ML-R	DV-1000CBL*	N/A	N/A
EA3-S3ML-RN			
EA3-T4CL	DV-1000CBL, D0-CBL	EA-2CBL	EA-2CBL-1
EA3-T6CL			
PLC List A	Productivity Series, Do-more / BRX**, CLICK, DL05, DL105, DL205, D3-350, D4-450 phone jack		
PLC List B	D2-250, D250-1, D2-260, DL06 VGA connector		
*Cable can provide +5VDC for panel power			
**BX-P-SER2-RJ12 is required			

Communication Ports

EA3-S3ML-RN & EA3-S3ML-R

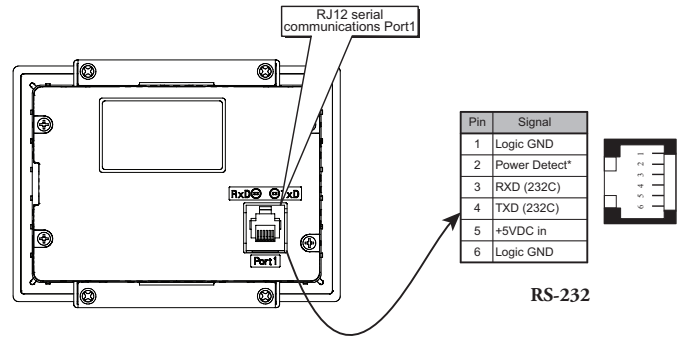

Drivers for your Controller

- AutomationDirect Productivity Series – serial / Ethernet*
- AutomationDirect Do-more / BRX – serial / Ethernet*
- AutomationDirect CLICK (Modbus(master only))– serial / Ethernet*
- Direct**LOGIC K-sequence, **Direct**LOGIC **Direct**NET, **Direct**LOGIC Modbus (master only) (Koyo Addressing) **Direct**LOGIC ECOM Ethernet*
- Modbus RTU (master only)
Modbus TCP/IP*
- Allen-Bradley DF1 Full Duplex, Allen-Bradley DF1 Half Duplex, Allen-Bradley PLC5 DF1, AB DH485, Allen-Bradley EtherNet/IP (Client) SLC5/05, NET-ENI, MicroLogix 1100/1400*, Control/CompactLogix (SLC mapping only)
- Omron Host Link (C200 Adapter, C500)
Omron FINS serial (CJ1, CS1)
- GE SNPX (90/30, 90/70, Micro 90, VersaMax Micro)
- Mitsubishi Melsec FX
- Siemens PPI
- Entity Modbus RTU (master only)
- AutomationDirect GS Drives
- AutomationDirect SOLO Temperature Controllers
- Mitsubishi Q/QnA

* Ethernet port is built in to EA3-S3ML and EA3-T4CL and EA3-T6CL require the optional EA-ECOM module for Ethernet.

EA3-S3ML & EA3-T4CL

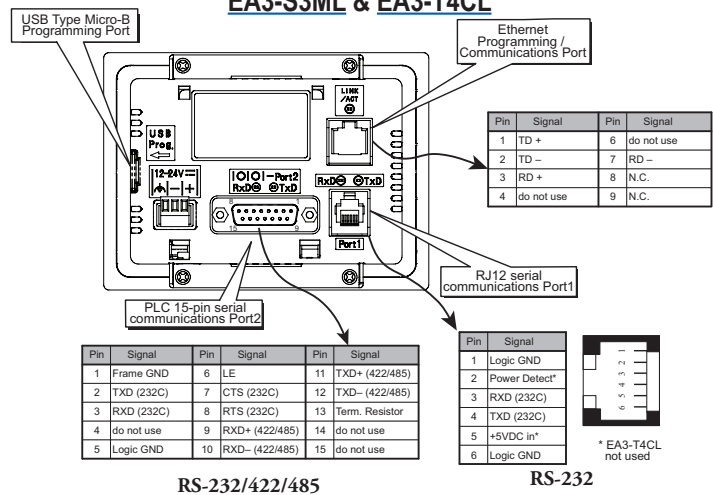

EA3-T6CL

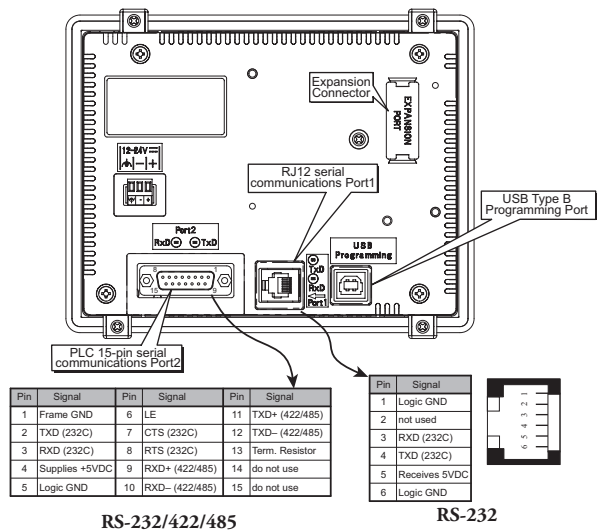

Communication Expansion Module

EA-ECOM Ethernet Communication Module

The EA-ECOM communication module is compatible with EA3 series **C-more** Micro 6-inch, 8-inch and 10-inch panels and most **C-more** panels. It adds an Ethernet (RJ45) port for programming and PLC communications at 10/100 Mbps. **C-more** Micro Software and firmware version 4.0 or later is required. **C-more** Software and firmware version 6.50 or later is required.

Part No. **EA-ECOM** \$86.00



Dimensions

Units: inches [mm]

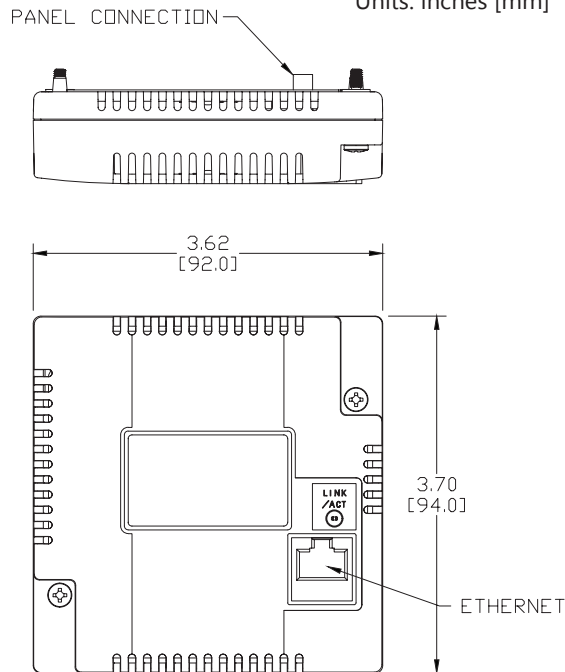

Ethernet Communication Interface Specifications	
Standard Specification	Conforms to IEEE802.3
Communication Speed	10/100 Base-T (Automatic Negotiation)
Cable Specification	Category 5
Auto MDI / MDI-X	Yes
Connector Type	RJ45

Communication Drivers	
C-more	C-more Micro
Supports all C-more Ethernet drivers	AutomationDirect Productivity Series Ethernet
	AutomationDirect Do-more / BRX Ethernet
	AutomationDirect CLICK Ethernet
	AutomationDirect ECOM Ethernet
	Modbus TCP/IP
	Allen-Bradley EtherNet/IP (Client) SLC5/05
	Allen-Bradley EtherNet/IP (Client) ENI Adapter
	Allen-Bradley EtherNet/IP (Client) MicroLogix 1100/1400
Allen-Bradley EtherNet/IP (Client) control/CompactLogix (SLC Mapping only)	



Link Status LED (Green)	
On	Ethernet Linked
Off	No Ethernet Comm.
Blinking Green	Comm. Activity



EA-ECOM Specifications

Part Number	EA-ECOM
Operating Temperature	0 to 50 °C (32 to 122 °F) Maximum surrounding air temperature rating: 50 °C
Storage Temperature	-20 to +60 °C (-4 to +140 °F)
Humidity	5-95% RH (non-condensing)
Environmental Air	For use in pollution degree 2 environment
Vibration	IEC60068-2-6 (Test Fc), 5-9 Hz: 3.5 mm amplitude, 9-150 Hz: 1.0G, sweeping, at a rate of 1 octave/min. (±10%), 10 sweep cycles per axis on each of 3 mutually perpendicular axes
Shock	IEC60068-2-27 (Test Ea), 15 G peak, 11ms duration, three shocks in each direction per axis, on 3 mutually perpendicular axes (total of 18 shocks)
Noise Immunity	NEMA ICS3-304 RFI, (145 MHz, 440 MHz 10 W @ 10 cm) Impulse 1000 V @ 1 µs pulse
Emission	EN55011 Class A (Radiated RF emission)
Enclosure (panel door installation)	NEMA 250 type 4/4X indoor use only UL50 type 4X indoor use only IP-65 indoor use only (When mounted correctly)
Agency Approvals	CE (EN61131-2), UL508, CUL Canadian C22.2 To obtain the most current agency approval information, see the Agency Approval Checklist section on the specific part number's web page
Mounting Torque	50 oz-in [0.35 N-m]
Weight	0.23 lb [105g]

C-more Micro EA3 Panel Accessories

D-SUB 15-pin 90-degree Communication Port Adapter

The **EA-ADPTR-4** adapter plugs into the 15-pin serial port on the rear of **C-more** Micro EA3 Series 3-inch*, 4-inch and 6-inch panels to allow a controller communication cable to be plugged in at a 90 degree angle to reduce panel depth requirements. 15-pin straight through pin-out. UL Recognized.

* EA3-S3ML-RN and EA3-S3ML-R are not equipped with a 15-pin serial port.

Part No.
EA-ADPTR-4



\$52.00

Dimensions

Units: inches [mm]

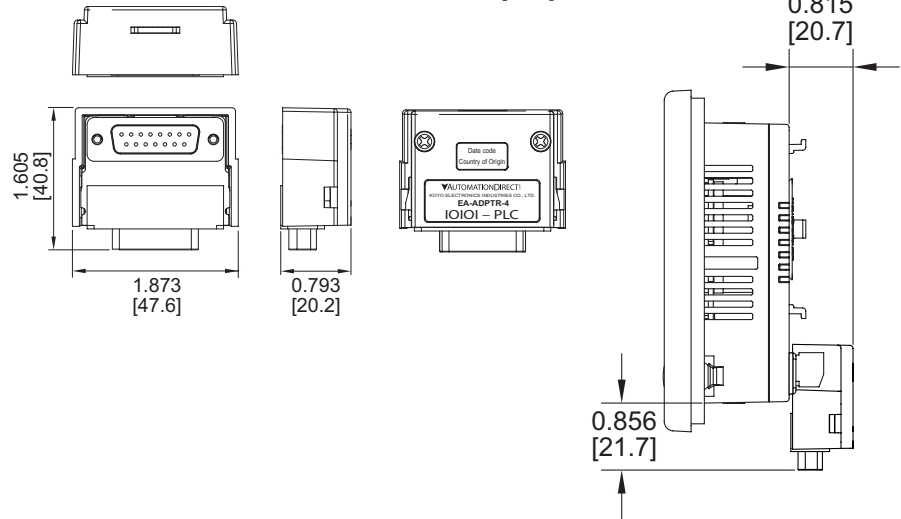

D-SUB 15-pin to Terminal Block Adapter

The **EA-COMCON-3** adapter plugs into the 15-pin serial port on the rear of **C-more** Micro EA3 Series 3-inch*, 4-inch and 6-inch panels to allow wire terminal connections for an RS-422/RS-485/DH485 PLC communication cable. UL Recognized.

* EA3-S3ML-RN and EA3-S3ML-R are not equipped with a 15-pin serial port.

Part No.
EA-COMCON-3



\$55.00

Dimensions

Units: inches [mm]

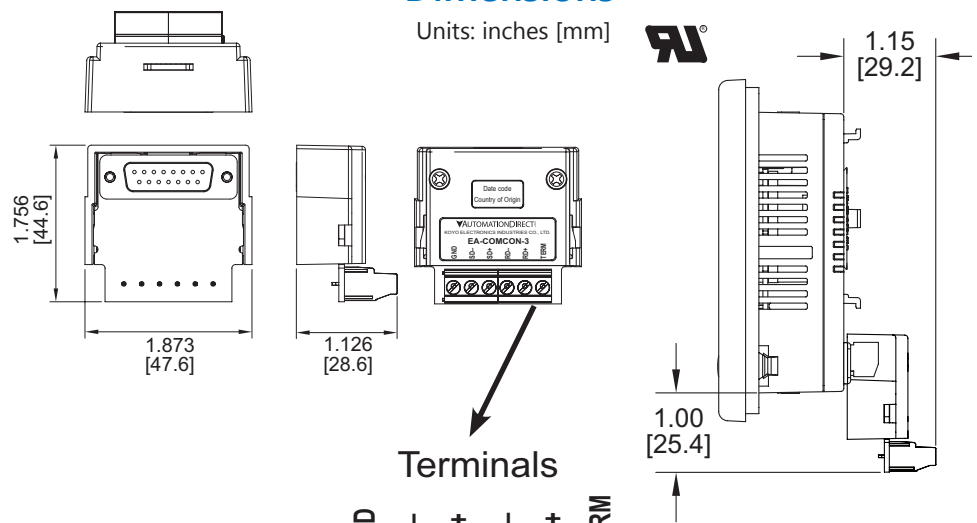

Terminals

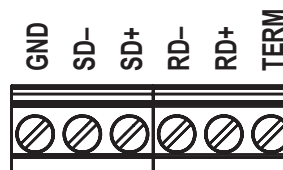

C-more Micro EA3 Panel Accessories

Clear Screen Overlay

Optional clear screen overlay used to protect **C-more** Micro displays from minor scratches and wear. EA-MG-COV-CL contains 5 clear screen overlays. All other packages contain 3 clear screen overlays.

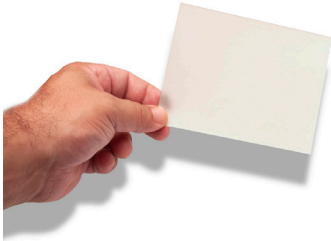

Part No. EA-MG-COV-CL
\$47.50

Part No. EA-4-COV3
\$45.50

Part No. EA-6-COV2
\$49.50

Part No. EA-8-COV2
\$53.00

Part No. EA-10-COV2
\$59.00

Dimensions

Units: inches [mm]

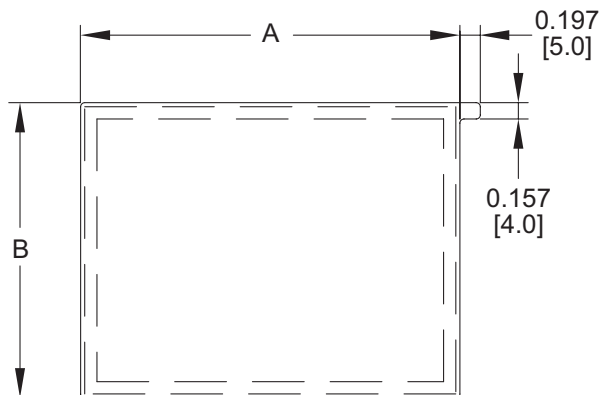

Part Number	Dimensions - inch [mm]	
	A	B
<u>EA-MG-COV-CL</u>	3.13 [79.4]	1.75 [44.4]
<u>EA-4-COV3</u>	4.15 [105.5]	2.52 [64.0]
<u>EA-6-COV2</u>	4.91 [124.8]	3.80 [96.4]
<u>EA-8-COV2</u>	7.32 [185.8]	5.44 [138.2]
<u>EA-10-COV2</u>	8.91 [226.2]	6.61 [168.0]

C-more Micro 6-inch EA3 Panel Replacement Parts

Replacement parts at a glance:

Part Number	Description	Price
<u>EA-MG-BZ2-BRK</u>	C-more Micro panel mounting brackets, replacement. Package of 8. For use with C-more Micro 4in and 6in panels, all 6in bezels, and 3in bezel EA-MG-BZ2.	\$24.00
<u>EA-MG-DC-CON</u>	C-more Micro DC 3-terminal power connector, replacement. Package of 5. For use with all C-more Micro 4in, 6in, 8in and 10in panels, and power adapters EA-MG-P1 and EA-MG-SP1.	\$19.00
<u>EA-MG6-S6ML-GSK</u>	C-more Micro panel mounting gasket, replacement. For use with C-more Micro 6in panels.	\$15.50
<u>EA-MG6-S6ML-FKL</u>	C-more Micro function key label insert, replacement. Package of 5. For use with C-more Micro 6in HMLs. (3) blank labels, (1) portrait F1-F5 label and (1) landscape F1-F5 label included.	\$38.50

Panel Mounting Clips
Part No. [EA-MG-BZ2-BRK](#)

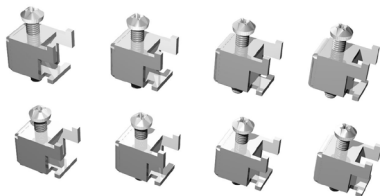

(pk of 8)

DC Power Connector
Part No. [EA-MG-DC-CON](#)

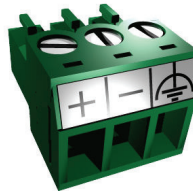

(pk of 5)

Function Keys Label Inserts
Part No. [EA-MG6-S6ML-FKL](#)

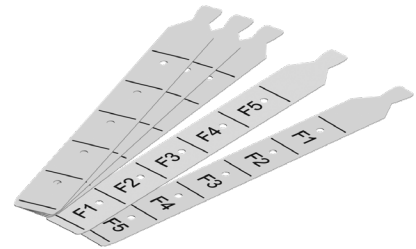

(pk of 5; 3 blank, 1 F1-F5 for landscape, 1 F1-F5 for portrait)

Panel Gasket
Part No. [EA-MG6-S6ML-GSK](#)



C-more Micro Communication Cables and Cable Kits

Cable Description	Cable Part Number	Price
Cables for direct connect to panel's serial Port1 (Panel powered from PLC's serial port.)		
Networking cable, RS-232 (RJ12 6P6C) to RS-232 (RJ12 6P6C), shielded, 12ft cable length. For use with CLICK, DL05, D2-240, D4-450 and Productivity3000 PLCs.	D0-CBL	\$47.50
DirectLOGIC DL06 connector, 15-pin D-sub HD15 male to RJ12 female. For use with DL06 CPUs and DL205 D2-250, D2-250-1, D2-260 and D2-262 CPUs.	FA-15HD	\$21.00
DirectLOGIC universal cable kit, for use with all DirectLOGIC PLCs with RS-232 ports.	FA-CABKIT	\$71.00
Cables used with serial Port2		
AutomationDirect communication cable, 15-pin male D-sub to 6-pin RJ12, shielded, 9.8ft/3m cable length. For use with C-more or C-more Micro panel and AutomationDirect PLCs with RJ12 ports.	EA-2CBL	\$37.00
AutomationDirect communication cable, 15-pin male D-sub to 15-pin D-sub HD15 male, shielded, 3m/9.8ft cable length. For use with C-more or C-more Micro panel and a DL06, D2-250(-1), D2-260 or D2-262 (bottom port) CPU.	EA-2CBL-1	\$38.00
AutomationDirect communication cable, 15-pin male D-sub to 4-pin RJ11, shielded, 3m/9.8ft cable length. For use with C-more or C-more Micro panel and a D3-340 CPU top or bottom port.	EA-3CBL	Retired
AutomationDirect communication cable, 15-pin male D-sub to 15-pin male D-sub, shielded, 3m/9.8ft cable length. For use with C-more or C-more Micro panel and a DL405 (top port) CPU.	EA-4CBL-1	\$37.00
AutomationDirect communication cable, 15-pin male D-sub to 25-pin male D-sub, shielded, 3m/9.8ft cable length. For use with C-more or C-more Micro panel and a D2-DCM, D3-232-DCU, D3-350 (bottom port) or DL405 (bottom port) CPU.	EA-4CBL-2	\$38.50
AutomationDirect communication cable, 15-pin male D-sub to 8-pin male mini DIN, shielded, 3m/9.8ft cable length. For use with C-more or C-more Micro panel and an Allen-Bradley Micrologix CPU.	EA-MLOGIX-CBL	\$57.00
AutomationDirect communication cable, 15-pin male D-sub to 9-pin female D-sub, shielded, 3m/9.8ft cable length. For use with C-more or C-more Micro panel and an Allen-Bradley SLC 5/03, 5/04 or 5/05 CPU with DF-1 port.	EA-SLC-232-CBL	\$37.00
AutomationDirect communication cable, 15-pin male D-sub to 25-pin male D-sub, 3m/9.8ft cable length. For use with C-more or C-more Micro panel and an Allen-Bradley PLC-5 CPU with a DF1 port.	EA-PLC5-232-CBL	\$37.00
AutomationDirect communication cable, 15-pin male D-sub to 6-pin RJ45, shielded, 3m/9.8ft cable length. For use with C-more or C-more Micro panel and an Allen-Bradley SLC 5/01, 5/02 or 5/03 CPU with a DH485 port cable.	EA-DH485-CBL	\$36.50
AutomationDirect communication cable, 15-pin male D-sub to 15-pin male D-sub, shielded, 3m/9.8ft cable length. For use with C-more or C-more Micro and GE Fanuc Series 90/30 or 90/70 serial port.	EA-90-30-CBL	\$37.00
AutomationDirect communication cable, 15-pin male D-sub to 25-pin male D-sub, 3m/9.8ft cable length. For use with C-more or C-more Micro panel and a Mitsubishi FX Series CPU.	EA-MITSU-CBL	\$31.00
AutomationDirect communication cable, 15-pin male D-sub to 8-pin male mini DIN, shielded, 3m/9.8ft cable length. For use with C-more or C-more Micro panel and a Mitsubishi FX Series CPU.	EA-MITSU-CBL-1	\$37.00
AutomationDirect communication cable, 15-pin male D-sub to 25-pin male D-sub, shielded, 3m/9.8ft cable length. For use with C-more or C-more Micro panel and an Omron C200 or C500 CPU.	EA-OMRON-CBL	\$37.00
Note: Adding the optional EA-ECOM module allows communication via an Ethernet connection (EA3 series only).		



[D0-CBL](#)



[FA-15HD](#)



[FA-CABKIT](#)



[EA-2CBL-1](#)



[EA-2CBL](#)

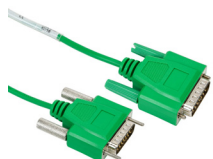

[EA-4CBL-1](#)



[EA-3CBL](#)



[EA-MLOGIX-CBL](#)



[EA-4CBL-2](#)



[EA-PLC5-232-CBL](#)



[EA-SLC-232-CBL](#)

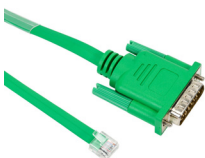

[EA-DH485-CBL](#)

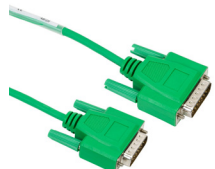

[EA-90-30-CBL](#)



[EA-MITSU-CBL](#)



[EA-MITSU-CBL-1](#)



[EA-OMRON-CBL](#)

C-more Micro Programming Software

FREE software!

C-more Micro Programming Software can be downloaded at no charge or a USB version may be purchased by ordering **EA-MG-PGMSW**. The software requires a USB port or Ethernet connection* on your PC to connect to the **C-more** Micro panel. Software Help Files are included in the download. This software programs all the **C-more** Micro panels (does not program the **C-more** 6-inch through 15-inch touch panels).



Copyright © AutomationDirect.com. All rights reserved.



Note: This software is used to program **C-more** Micro panels only.



Note: The Ethernet port is built in to **EA3-S3ML** and **EA3-T4CL** and **EA3-T6CL** requires the optional **EA-ECOM** module for Ethernet.

Part Number	Panel Software / Firmware Version Required
EA3-S3ML-RN	4.30 or later
EA3-S3ML-R	
EA3-S3ML	4.20 or later
EA3-T4CL	
EA3-T6CL	3.6 or later

C-more Micro Programming Software is a spin-off of its powerful sibling **C-more**

Touch Panel. It offers very high end features designed to reduce your configuration time. Simply drag and drop the objects from the object list (right side of screen) onto the screen construction area. Then configure your PLC tags and click on the objects you wish to use. Use the built-in simulator to review your work on your PC before ever downloading your project! The time saving benefits of the **C-more** Micro configuration software could easily pay for the panel. Check out www.CmoreMicro.com to download a free version.

Thumbnail project preview pane

Helps keep track of multi-screen projects.

Built-in project simulator

- Runs your project on your PC
- Test all of your screens before downloading
- Time savings pays for the panel
- Simulate function keys and keypad bezel

Built-in user object/ screen libraries

Save time by re-using your custom objects and screens.

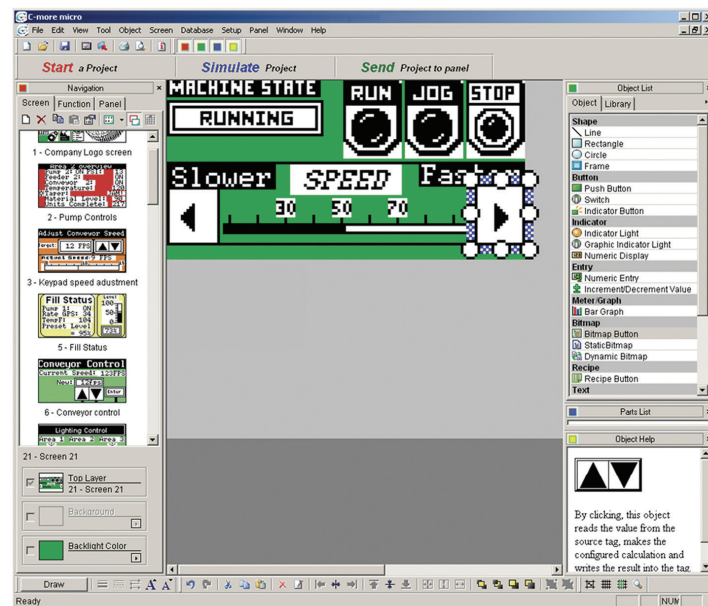

Scrolling object selection window

Lets you find the object you want fast. Just drag and drop it on the screen.

PC requirements

Following are the minimum system requirements for running **C-more** Micro Programming Software, **EA-MG-PGMSW**, on a PC:

- Windows® Operating System (See automationdirect.com for specific operating system requirements.)
- 150 MB free hard-disk space
- USB port for installing software from the USB, or internet access to download free programming software
- USB port to use with the correct Programming Cable Assembly for project transfer from the programming software to the panel

Scrolling help window

Gives you helpful information on each object