

Dold UH6932 Speed Monitor Relays



UH6932 speed monitoring safety relay modules use inputs from proximity sensors that are detecting rotating targets on the motor that needs monitoring.

- Two PNP or NPN sensors
- Adjustable range
- Monitors rotation and linear movement
- LED status indicators
- Time delay settings available

Safety Data – Values per EN ISO 13849-1

Category	4
Performance level	e
MTTF_d	146.1 years
DC_{avg}	99%

Safety Data – Values per IEC/EN 62061/IEC/EN 61508

SIL CL	3
SIL	3
HFT (Hardware Failure Tolerance)	1
DC_{avg}	99%
PFH_D	1.8e-10

Safety Speed Monitor Relays Selection Chart

Part Number	Price	Marking Type	Voltage	Sensor Input	Outputs
UH6932-02PS-24	\$569.00	Digital speed-monitoring safety relay module	24VDC	NPN	2 N.O. and 1 N.C.
UH6932-02PS-010-24	\$569.00			PNP	

Safety Speed Monitor Relay Module Specification Table

General Specifications	
Temperature	Storage: -20°C to 70°C (-4°F to 158°F) – Operating: -20°C to 60°C (-4°F to 140°F)
Altitude	< 2,000m (6562ft)
Vibration Resistance	IEC/EN 60-068-2-6
Degree of Protection	Housing: IP40; Terminals IP20
Housing	UL 94V-0 Thermoplastic; DIN mount 35mm (1.38 in) x 7.5 mm (0.30 in)
Weight	320g (11.29 oz.)
Agency Approvals and Standards	cULus file E107778, CE, RoHS
Terminal Designation	EN 50005
Wire Fixing	Captive slotted screw. Torque 0.8 Nm (7 lb-in)
Input Specifications	
Nominal Voltage	24VDC
Voltage Range	0.8 to 1.1 VDC
Nominal Consumption	Typ 3.2 W
Nominal Frequency	–
Control Current	Maximum 30mA
Overvoltage Protection	Internal VDR (Voltage Dependent Resistor)
Sensor Inputs	Output: PNP or NPN HIGH-level: 10 - 26.4 VDC LOW-level: < 2VDC Min. pulse duration (e.g. on and off time): 75µs Input frequency: < 3kHz
Output Specifications	
Electrical Contact Life	To AC15 at 3A, 230V: 2.2x10 ⁵ switching cycles IEC/EN 60 947-5-1
Mechanical Life	20x10 ⁶ switching cycles
Contact Type	2 N.O. positively driven and 2 semiconductor monitoring outputs
Reaction Time of Frequency Monitoring	Duration of 1 cycle (inverse value of adjusted frequency) + 10ms + adjusted response delay
Nominal Output Voltage	250VAC
Thermal Current (I_{th})	Max. 8A per contact. See continuous current limit curve in installation manual.
Short Circuit Strength	Max fuse rating: 10A gl (IEC/EN 60 9470-5-1)
Switching Capacity IEC/EN 60 947-5-1	AC15: 3A/230V; DC13: 2A/24V
Switching Frequency	Max. 1,200 switching cycles/hr

Dold UH6932 Speed Monitor Relays



Function Diagram

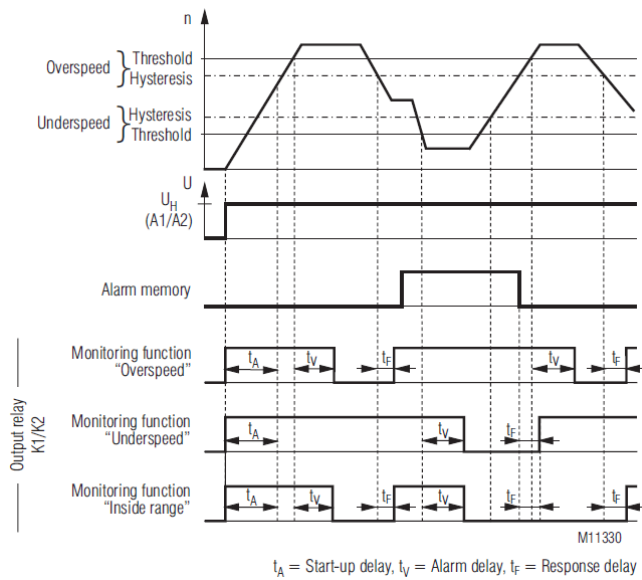

Block Diagram

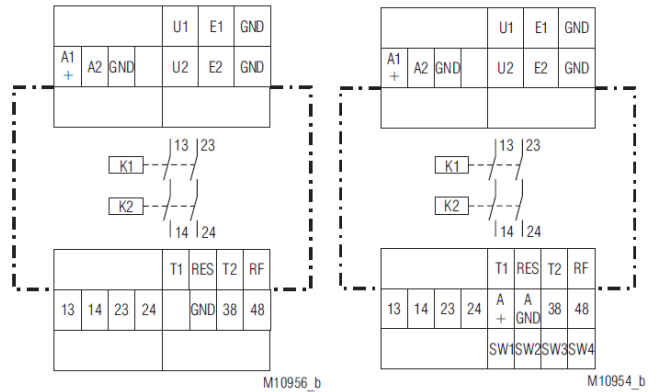

Dimensions

mm [in]

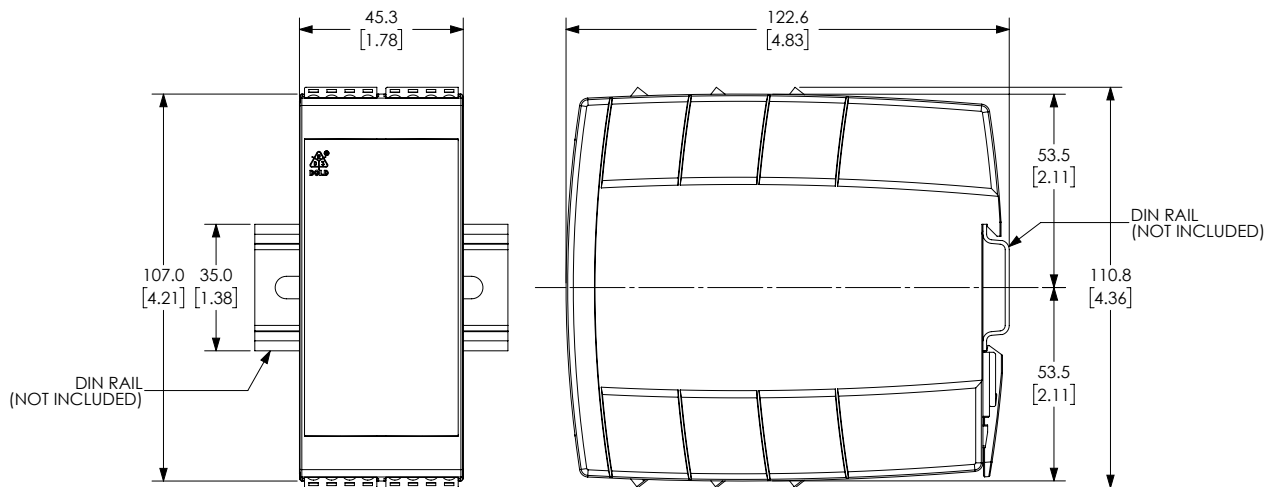

Dold UH6932 Speed Monitor Relays



Application Examples

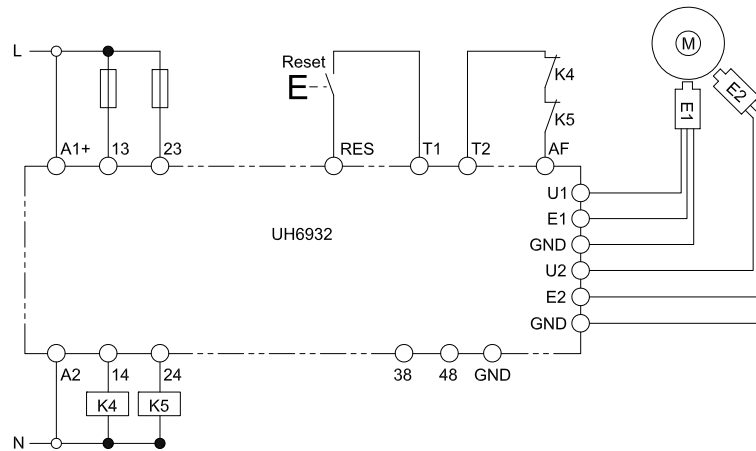

Standard connection

Suited up to SIL3, Performance Level e, Cat.4

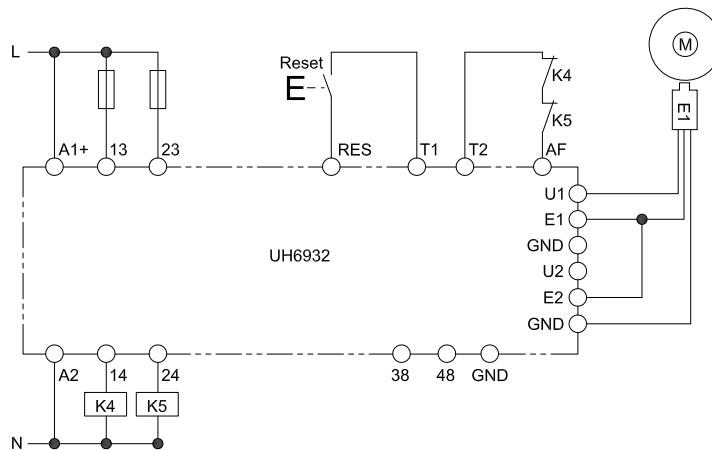

Connection with a proximity sensor

Suited up to SIL2, Performance Level c, Cat.2

(To achieve Cat. 2, the safety function has to be tested on a regular basis.)

Safety Products



Warning: Safety products sold by AutomationDirect are Safety components only. The purchaser/installer is solely responsible for the application of these components and ensuring all necessary steps have been taken to assure each application and use meets all performance and applicable safety requirements and/or local, national and/or international safety codes as required by the application. AutomationDirect cannot certify that our products, used solely or in conjunction with other AutomationDirect or other vendors' products, will assure safety for any application. Any person using or applying any products sold by AutomationDirect is responsible for learning the safety requirements for their individual application and applying them, and therefore assumes all risks, and accepts full and complete responsibility, for the selection and suitability of the product for their respective application.

AutomationDirect does not provide design or consulting services, and cannot advise whether any specific application or use of our products would ensure compliance with the safety requirements for any application.