

DINnectors® Triple-level and Sensor Terminal Blocks

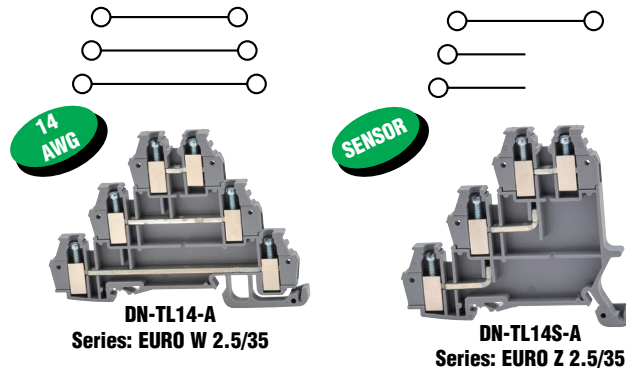

- Screw connection terminal
- 35mm DIN-rail mountable
- LVD 2006/95/EC

Triple-level terminal blocks enable high-density wiring or simplified, low-cost sensor wiring.

When wiring space is at a premium, use the DN-TL14-A to connect three separate circuits in only 5mm of linear DIN-rail space. The rest of our family of triple-level blocks will allow you to wire one terminal block per sensor, vs. the traditional method, which requires three different single-level blocks per sensor.

The DN-TL14S-A is the standard sensor terminal block, and the DN-TL14SLP-A and DN-TL14SLN-A provide LED indication at the terminal block when voltage is present.

Ordering Information							
	Part Number	Pcs/Pkg	Price	Part Number	Pcs/Pkg	Price	
Color Gray	DN-TL14-A	25	\$41.50	DN-TL14S-A	25	\$36.00	
Technical Specifications							
Stripping Length	10 mm [0.39 in]			10 mm [0.39 in]			
Tightening Torque	0.5 N-m [4.5 lb-in]			0.5 N-m [4.5 lb-in]			
Density	200/m [57 pcs/ft]			200/m [57 pcs/ft]			
UL Approval*	300V	10A	26-14 AWG	300V	10A	26-14 AWG	
CSA Approval	300V	10A	26-14 AWG	300V	10A	26-14 AWG	
VDE Approval	300V	10A	2.5 mm ²	300V	10A	2.5 mm ²	
Operating Temperature	Ambient air temperature: -20°C to 105°C [-4°F to 221°F] Relative humidity: 50% max at 40°C [104°F]; 90% max at 20°C [68°F]						
SCCR Rating	100kA per Table SB4.1, 2009, UL 508A, Maximum short circuit current rating for unmarked components						
CE Conformity	CE (EN 60947-1 / EN 60947-7-1)						
Agency File #	UL E179129						
<i>Note: To obtain the most current agency approval information, see the Agency Approval Checklist section on the specific part number's web page.</i>							
Accessories							
End Covers	DN-EC14	25	\$10.50	DN-EC14S	25	\$9.25	
Jumpers	2-pole Blue	DN-2JL14B-A	100	\$39.50	DN-2JL14B-A	100	\$39.50
		DN-2JL14B-AMN	25	\$9.25	DN-2JL14B-AMN	25	\$9.25
	3-pole Blue	DN-3JL14B-A	100	\$59.00	DN-3JL14B-A	100	\$59.00
		DN-3JL14B-AMN	25	\$13.00	DN-3JL14B-AMN	25	\$13.00
	12-pole Blue	DN-12JL14B-A	10	\$15.50	DN-12JL14B-A	10	\$15.50
	2-pole Red	DN-2JL14-A	100	\$39.50	DN-2JL14-A	100	\$39.50
		DN-2JL14-AMN	25	\$9.25	DN-2JL14-AMN	25	\$9.25
	3-pole Red	DN-3JL14-A	100	\$59.00	DN-3JL14-A	100	\$59.00
		DN-3JL14-AMN	25	\$13.00	DN-3JL14-AMN	25	\$13.00
	12-pole Red	DN-12JL14-A	10	\$15.50	DN-12JL14-A	100	\$15.50
	Jumper Cutting Tool	DN-JL14CUT	1	\$66.00	DN-JL14CUT	1	\$66.00
	35mm DIN Rail	7.5 mm high	DN-R35S1	10	\$28.00	DN-R35S1	10
DN-R35S1-2			2	\$9.25	DN-R35S1-2	2	\$9.25
15mm high		DN-R35HS1	10	\$50.00	DN-R35HS1	10	\$50.00
		DN-R35HS1-2	2	\$12.50	DN-R35HS1-2	2	\$12.50
End Brackets	DN-EB35	50	\$40.00	DN-EB35	50	\$40.00	
	DN-EB35MN	20	\$18.50	DN-EB35MN	20	\$18.50	
	DN-EB35-A	50	\$28.50	DN-EB35-A	50	\$28.50	
	DN-EB35-A-10	10	\$7.75	DN-EB35-A-10	10	\$7.75	
	DN-QEB35	50	\$25.50	DN-QEB35	50	\$25.50	
	DN-QEB35-10	10	\$7.75	DN-QEB35-10	10	\$7.75	
Angled Support Bracket	DN-ASB1	50	\$50.00	DN-ASB1	50	\$50.00	
Marking Tags	DN-LAT-A series	500	various	DN-LAT-A series	500	various	
*Copper wire only							
For more information on accessories, see the DINnectors Accessories section of this chapter.							

Dimensions

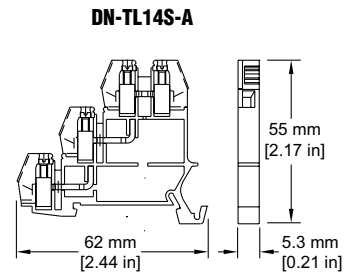
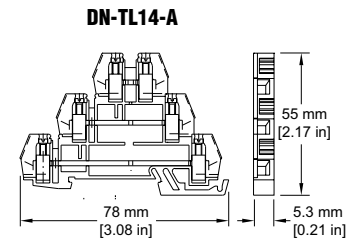

DINnectors® Triple-level and Sensor Terminal Blocks

Sensor wiring has never been this simple.

- A** Wire the bottom two levels of one DN-TL14-A to connect your power supply to what will become a sensor +V and -V power bus.
- B** Mount the triple-level sensor blocks next to the DN-TL14-A. The DN-TL14S-A is our standard sensor terminal block. The DN-TL14SLP-A gives you LED indication for PNP sensors, and the DN-TL14SLN-A gives you LED indication for NPN sensors.
- C** Use the top level to connect the first sensor signal line to the PLC.
- D** Connect the power supply terminals of the DN-TL14-A to the LED sensor terminal blocks by installing jumpers. This will create a +V and -V power bus on the two bottom levels of the terminals. Use an external wire to connect a group of 12 DN-TL14-As to another group.
- E** Wire the sensor signal lines through the top levels of the blocks to your PLC or controller. Remember to use the appropriate end covers to cover any exposed metal parts for safety purposes.

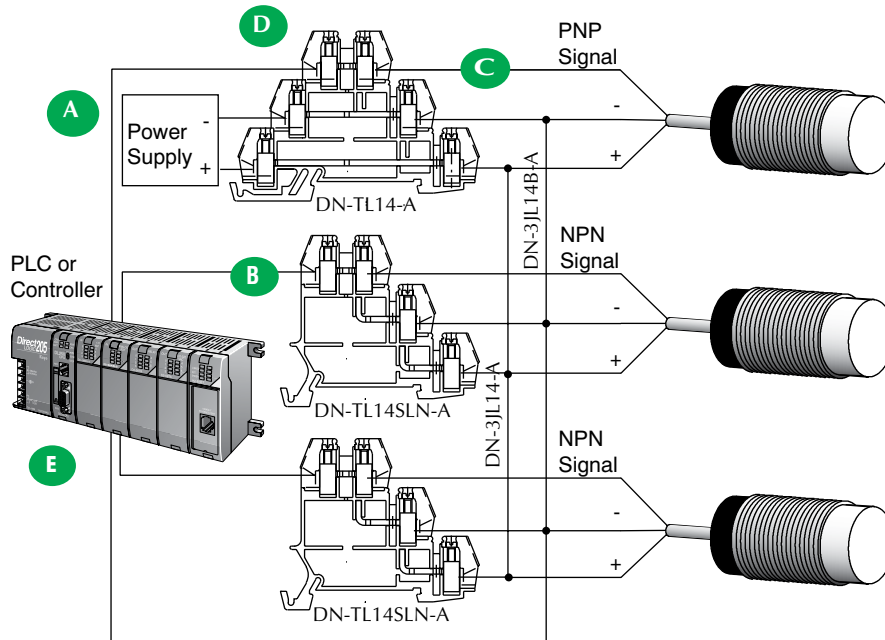

Note: Wiring schematic is for reference only. See individual I/O modules for correct wiring connections.



Triple-level and Sensor Terminal Blocks with LED

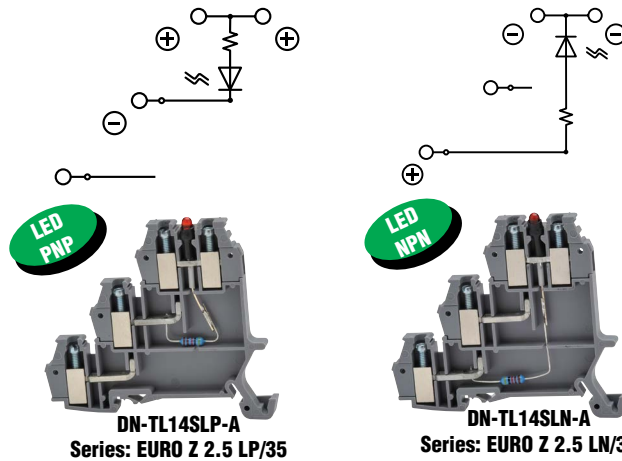

- Screw connection terminal
- 35mm DIN-rail mountable
- LVD 2006/95/EC

Dimensions

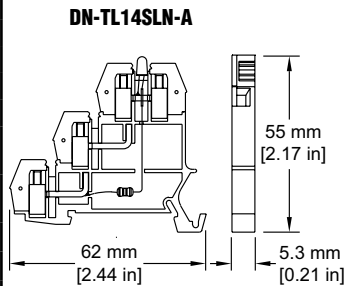
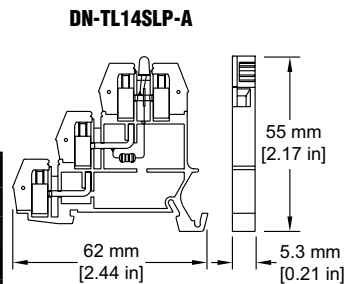

Ordering Information						
Color	Part Number	Pcs/Pkg	Price	Part Number	Pcs/Pkg	Price
Gray	DN-TL14SLP-A	25	\$71.00	DN-TL14SLN-A	25	\$71.00
Technical Specifications						
Stripping Length	10 mm [0.39 in]			10 mm [0.39 in]		
Tightening Torque	0.5 N-m [4.5 lb-in]			0.5 N-m [4.5 lb-in]		
Density	200/m [57 pcs/ft]			200/m [57 pcs/ft]		
Leakage Current	25mA@5V			25mA@5V		
LED Voltage/Resistance	12 – 24V AC/DC. 3.4 kΩ			12 – 24V AC/DC. 3.4 kΩ		
UL Approval*	300V	10A	26-14 AWG	300V	10A	26-14 AWG
CSA Approval	300V	10A	26-14 AWG	300V	10A	26-14 AWG
VDE Approval	300V	10A	2.5 mm ²	300V	10A	2.5 mm ²
Operating Temperature	Ambient air temperature: -20°C to 105°C [-4°F to 221°F] Relative humidity: 50% max at 40°C [104°F]; 90% max at 20°C [68°F]					
SCCR Rating	100kA per Table SB4.1, 2009, UL 508A, Maximum short circuit current rating for unmarked components					
CE Conformity	CE (EN 60947-1 / EN 60947-7-1)					
Agency File #	UL E179129					

Note: To obtain the most current agency approval information, see the Agency Approval Checklist section on the specific part number's web page.

Accessories							
End Cover	DN-EC14S	25	\$9.25	DN-EC14S	25	\$9.25	
Jumpers	2-pole Blue	DN-2JL14B-A	100	\$39.50	DN-2JL14B-A	100	\$39.50
		DN-2JL14B-AMN	25	\$9.25	DN-2JL14B-AMN	25	\$9.25
	3-pole Blue	DN-3JL14B-A	100	\$59.00	DN-3JL14B-A	100	\$59.00
		DN-3JL14B-AMN	25	\$13.00	DN-3JL14B-AMN	25	\$13.00
	12-pole Blue	DN-12JL14B-A	10	\$15.50	DN-12JL14B-A	10	\$15.50
	2-pole Red	DN-2JL14-A	100	\$39.50	DN-2JL14-A	100	\$39.50
		DN-2JL14-AMN	25	\$9.25	DN-2JL14-AMN	25	\$9.25
	3-pole Red	DN-3JL14-A	100	\$59.00	DN-3JL14-A	100	\$59.00
		DN-3JL14-AMN	25	\$13.00	DN-3JL14-AMN	25	\$13.00
	12-pole Red	DN-12JL14-A	10	\$15.50	DN-12JL14-A	10	\$15.50
	Jumper Cutting Tool	DN-JL14CUT	1	\$66.00	DN-JL14CUT	1	\$66.00
	35mm DIN Rail	7.5 mm high	DN-R35S1	10	\$28.00	DN-R35S1	10
DN-R35S1-2			2	\$9.25	DN-R35S1-2	2	\$9.25
15mm high		DN-R35HS1	10	\$50.00	DN-R35HS1	10	\$50.00
		DN-R35HS1-2	2	\$12.50	DN-R35HS1-2	2	\$12.50
End Brackets	DN-EB35	50	\$40.00	DN-EB35	50	\$40.00	
	DN-EB35MN	20	\$18.50	DN-EB35MN	20	\$18.50	
	DN-EB35-A	50	\$28.50	DN-EB35-A	50	\$28.50	
	DN-EB35-A-10	10	\$7.75	DN-EB35-A-10	10	\$7.75	
	DN-QEB35	50	\$25.50	DN-QEB35	50	\$25.50	
	DN-QEB35-10	10	\$7.75	DN-QEB35-10	10	\$7.75	
Angled Support Bracket	DN-ASB1	50	\$50.00	DN-ASB1	50	\$50.00	
Marking Tags	DN-LAT-A series	500	various	DN-LAT-A series	500	various	

*Copper wire only

For more information on accessories, see the DINnectors Accessories section of this chapter.

DINnectors® Accessories

**DN-LB (blank)
shown on right**

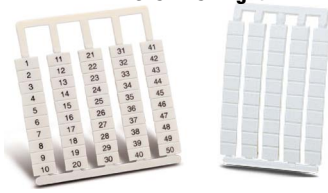

DN-L

- **Fits terminal block types:** All except Screwless DINnectors, DN-T12-A, DN-M10-A, DN-MG, and DN-TL series
- **Material:** Thermoplastic with heat embossed black print

Note:

1. The marking sequence of 50 tags (i.e. 101-150) is printed 10 times in each package of 500 tags.
2. The DN-L tags fit all DINnectors 6mm wide and wider.
3. The DN-L tags fit all DINnectors 6mm wide and wider but will leave gap between tags on blocks wider than 6mm.

Dimensions

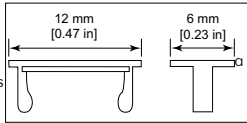

Marking Sequence	Part#	Pcs/Pkg	Price
1-50	DN-L50	500	\$33.00
51-100	DN-L100	500	\$33.00
101-150	DN-L150	500	\$33.00
151-200	DN-L200	500	\$33.00
201-250	DN-L250	500	\$33.00
251-300	DN-L300	500	\$33.00
301-350	DN-L350	500	\$33.00
351-400	DN-L400	500	\$33.00
401-450	DN-L450	500	\$33.00
Blank	DN-LB	500	\$22.50
L1, L2, L3, L, N, GND, +, -, COM, COM*	DN-LS	500	\$33.00

DN-QL

- **Fits terminal block types:** Screwless DN-Q series
- **Material:** Thermoplastic with heat embossed black print. Packaged 100 labels per card, and five cards per box.

Note:

1. The marking sequence (i.e. 1-100) is printed five times in each package of 500 tags.

Dimensions

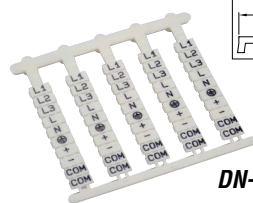
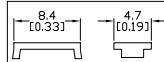

DN-QLS Shown

Marking Sequence	Part #	Pcs/Pkg	Price
1-100	DN-QL100	500	\$25.50
101-200	DN-QL200	500	\$25.50
201-300	DN-QL300	500	\$25.50
301-400	DN-QL400	500	\$25.50
401-500	DN-QL500	500	\$25.50
Blank Tags	DN-QLB	500	\$22.00
L1, L2, L3, L, N, ⊕, +, -, COM, COM*	DN-QLS	500	\$29.00

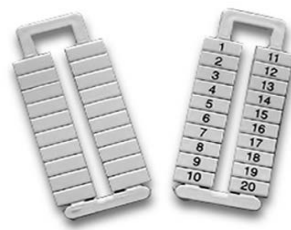

**DN-LAB (blank) shown on left;
part of DN-LA100 on right**

DN-LA

- **Fits terminal block types:** DN-T12-A series
- **Material:** Thermoplastic with heat embossed black print

Note:

1. The marking sequence (i.e. 1-100) is printed five times in each package of 500 tags.
2. The DN-T12-A series is 5mm wide, so the 6mm wide DN-L tags do not fit these blocks.
3. The DN-LA tags fit all DINnectors 5mm wide and wider but will leave a gap between tags on blocks wider than 5mm.

Dimensions

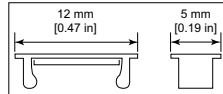

Marking Sequence	Part#	Pcs/Pkg	Price
1-100	DN-LA100	500	\$33.00
101-200	DN-LA200	500	\$33.00
201-300	DN-LA300	500	\$33.00
301-400	DN-LA400	500	\$33.00
Blank Tags	DN-LAB	500	\$33.00
L1, L2, L3, L, N, GND, +, -, COM, COM*	DN-LAS	500	\$33.00

DN-LAT-A

- **Fits terminal block types:** Triple level DN-TL14
- **Material:** Thermoplastic with heat embossed black print

Note:

1. The marking sequence (i.e. 1-100) is printed five times in each package of 500 tags.

Dimensions

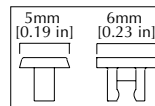

Marking Sequence	Part #	Pcs/Pkg	Price
1-100	DN-LAT100-A	500	\$29.00
101-200	DN-LAT200-A	500	\$29.00
201-300	DN-LAT300-A	500	\$29.00
301-400	DN-LAT400-A	500	\$29.00
401-500	DN-LAT500-A	500	\$29.00
501-600	DN-LAT600-A	500	\$29.00
Blank Tags	DN-LATB-A	500	\$21.50
L1, L2, L3, L, N, ⊕, +, -, COM, COM*	DN-LATS-A	500	\$29.00



DN-LTA marker shown top; DN-LT60 marker shown middle; DN-LTGND shown bottom

DN-LT

- **Fits terminal block types:** All except Screwless DINnectors (see DN-QL series)
- **Material:** Thermoplastic with heat embossed black print

Note:

1. These marking tags allow the flexibility of creating custom marking sequences on site.
2. The DN-M10-A support a maximum of three digits (tags), while other DINnectors support up to four digits (tags)

Dimensions

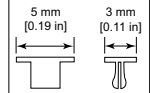

Marking Sequence	Part#	Pcs/Pkg	Price
1-5	DN-LT15	100	\$6.00
6-0	DN-LT60	100	\$6.00
1	DN-LT1	100	\$6.00
2	DN-LT2	100	\$6.00
3	DN-LT3	100	\$6.00
4	DN-LT4	100	\$6.00
5	DN-LT5	100	\$6.00
6	DN-LT6	100	\$6.00
7	DN-LT7	100	\$6.00
8	DN-LT8	100	\$6.00
9	DN-LT9	100	\$6.00
0	DN-LT0	100	\$6.00
Unprinted	DN-LTBLNK	100	\$6.00
A	DN-LTA	100	\$6.00
B	DN-LTB	100	\$6.00
C	DN-LTC	100	\$6.00
D	DN-LTD	100	\$6.00
E	DN-LTE	100	\$6.00
F	DN-LTF	100	\$6.00
G	DN-LTG	100	\$6.00
H	DN-LTH	100	\$6.00
I	DN-LTI	100	\$6.00
J	DN-LTJ	100	\$6.00
K	DN-LTK	100	\$6.00
L	DN-LTL	100	\$6.00
M	DN-LTM	100	\$6.00
N	DN-LTN	100	\$6.00
-	-	-	-
P	DN-LTP	100	\$6.00
Q	DN-LTQ	100	\$6.00
R	DN-LTR	100	\$6.00
S	DN-LTS	100	\$6.00
T	DN-LTT	100	\$6.00
U	DN-LTU	100	\$6.00
V	DN-LTV	100	\$6.00
W	DN-LTW	100	\$6.00
X	DN-LTX	100	\$6.00
Y	DN-LTY	100	\$6.00
Z	DN-LTZ	100	\$6.00
⊕	DN-LTGND	100	\$6.00
+	DN-LTPOS	100	\$6.00
-	DN-LTNEG	100	\$6.00
~	DN-LTAC	100	\$6.00
=	DN-LTDC	100	\$6.00

DINnectors® Accessories

Terminal Marking Accessories



DN-EMLBL1



DN-EMLBL2



DN-EMLBL3

Part #	Description	For Use With	Pcs/Pkg	Price Each
DN-EMLBL1	Blank labels	DN-EMPEG1 pin protectors for DN-xEMXxx plug-in terminal blocks	100	\$5.50
DN-EMLBL2	Labels printed 1 – 12		100	\$7.50
DN-EMLBL3	Labels printed 13 – 24		100	\$7.50

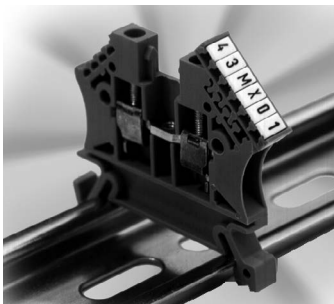

DN-MTA marking tag adapter

DN-MTA dimensions

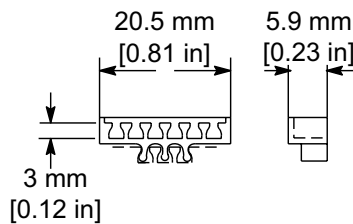

Part#	Description	Pcs/Pkg	Price Each
DN-MTA	Marking tag adapter holds up to six DN-LT tags	50	\$8.25

Note: DN-MTA adapter does not fit DN-T12-A terminal blocks.

Marking Pen – for terminal and wire marking tags

- Permanent
- Smudge-proof
- Waterproof
- Weatherproof
- Lightfast (won't fade)
- Dries in seconds (excellent for left-handed users)
- Dry-safe (pen can be left uncapped for days without drying out)
- Low odor ink

Part#	Description	Pcs/Pkg	Price Each
DN-MP	Indelible black ink marking pen	1	\$3.75



Marking pen

Wire Marking Accessories



DN-WMTAG1 wire tags & DN-WM-x wire tag holders

Part #	Description	For Use With	Pcs/Pkg	Price Each
DN-WMTAG1	Wire tag – blank	all DN-WM-x wire tag holders	525	\$35.00
DN-WM-1	Wire tag holder, clear, 12mm length, 0.051–0.118 in diameter; for 22–16 AWG wire	DN-WMTAG1	200	\$7.25
DN-WM-2	Wire tag holder, clear, 12mm length, 0.098–0.196 in diameter; for 16–11 AWG wire		200	\$7.25
DN-WM-3	Wire tag holder, clear, 12mm length, 0.157–0.393 in diameter; for 13–5 AWG wire		100	\$4.75
DN-WM-4	Wire tag holder, clear, 12mm length, 0.314–0.629 in diameter; for 5AWG wire		100	\$4.25