

# ECX Series 22mm Metal Pilot Devices

## Audible annunciator



- 80dB @ 10cm
- 25mA @ 24V
- Intermittent sound when energized
- IP20 before installation
- IP65 after installation

Part Number	Color	Price	Description
<b>ECX2070-24</b>	Black	\$6.50	22mm, 25mA audible (80dB at 10cm) buzzer annunciator. 24VAC/DC
<b>ECX2070-127</b>	Black	\$6.50	22mm, 25mA audible (80dB at 10cm) buzzer annunciator. 120VAC/DC
<b>ECX2071-24R</b>	Red	\$8.50	22mm, 25mA audible (80dB at 10cm) buzzer annunciator with non-replaceable LED indicator. 24VAC/DC
<b>ECX2071-127R</b>	Red	\$8.50	22mm, 25mA audible (80dB at 10cm) buzzer annunciator with non-replaceable LED indicator. 120VAC/DC

Dimensions: mm [inches]

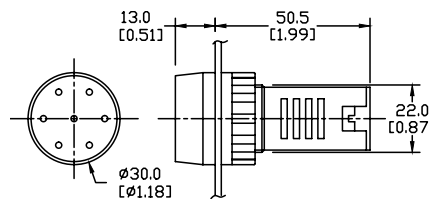

## 22mm potentiometer

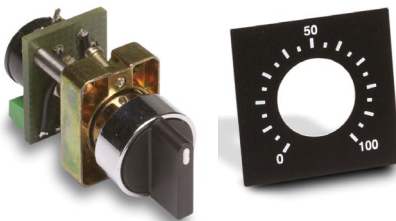

Part Number	Quantity	Price	Description
<b>ECX2300-5K</b>	pkg. of 1	\$36.50	22mm potentiometer with 5kΩ resistance, ±10%. Nominal voltage: 250V. Rated dissipation: 2W at 25°C. Temperature range -40°C to 70°C. Black handle. Connection type is screw terminal, 3-pole, 22-14 AWG.
<b>ECX2300-10K</b>	pkg. of 1	\$36.50	22mm potentiometer with 10kΩ resistance, ±10%. Nominal voltage: 250V. Rated dissipation: 2W at 25°C. Temperature range -40°C to 70°C. Black handle. Connection type is screw terminal, 3-pole, 22-14 AWG.
<b>ECX2640</b>	pkg. of 1	\$3.50	22mm legend plate for potentiometer with 0% to 100% marking, 50mm square. 50 x 50 x 1mm with 24.5 mm cutout.

- IP65

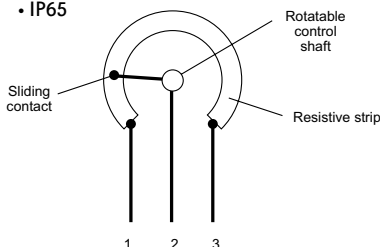

Dimensions: mm [inches]

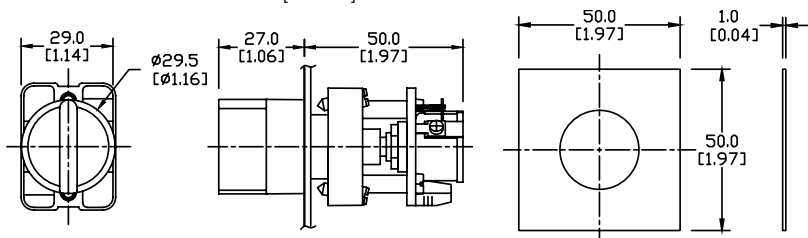

For accessories, see 22mm Metal Pilot Device Accessories in this section.

# GCX Series 22mm Plastic Pilot Devices Specifications

## Assembly information

These pushbuttons and indicator lights are supplied with the appropriate contact blocks, unless otherwise indicated. Use these drawings as a guide to make sure there is adequate clearance behind the panel.

### Pushbuttons and selector switches

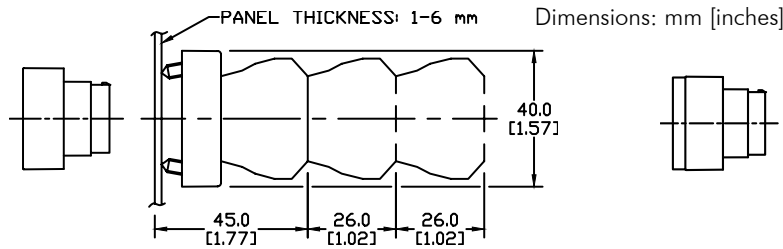

### Illuminated pushbuttons and selector switches/indicator lights

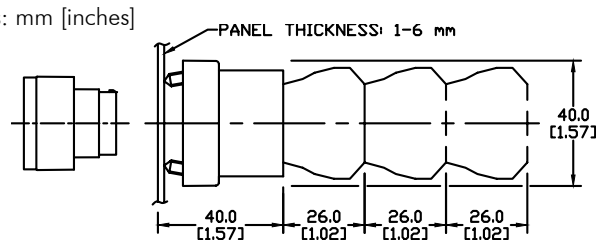

## Mounting

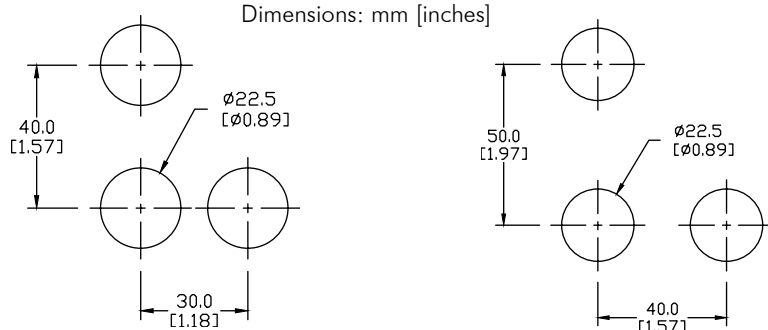

This layout is suitable if all switches are 230V or less and the same polarity.

This layout is suitable if all switches are 400V or less and different polarity.

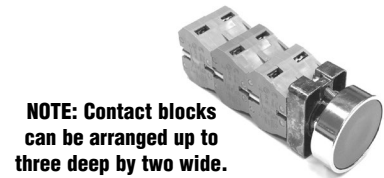

**NOTE: Contact blocks can be arranged up to three deep by two wide.**

### Typical Wiring

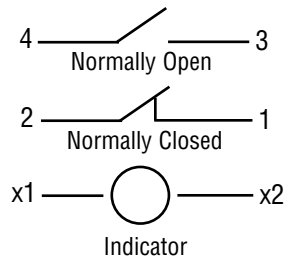

## Specifications

These specifications apply to all the GCX and ECX 22mm plastic pushbuttons and switches.

Physical Specifications		Electrical Specifications	
<b>Standards Reference</b>	CEI EN 60947-5-1, CSA C22-2 n.14	<b>Rated Thermal Current (contact block)</b>	A300, Q300 (Refer to E22 Series mounting/contact rating section for details)
<b>Approvals</b>	UL File E189258, IMQ (where specified)	<b>Rated Insulation Voltage</b>	Ui 660V according to CEI EN 60947-5-1, 300V according to CSA C22-2 n.14 and UL 508
<b>Enclosure Material</b>	Fiberglass reinforced thermoplastic	<b>Dielectric Strength</b>	3kV (1 second)
<b>Contacts Material</b>	Silver	<b>Insulation Resistance</b>	2MΩ min. (500VDC)
<b>Protection Degree</b>	IP 40 for GCX3151-24, GCX3151-120, GCX3153-24 and GCX3153-120. IP 65 for all others. (See Appendix of this catalog for explanation of IP ratings according to IEC 144 CEI 70-1.)	<b>Initial Contact Resistance</b>	≤25mΩ
<b>Electric Shock Protection</b>	IEC 536, Class II	<b>Short-Circuit Protection*</b>	Cartridge fuses gl 10 A-500V 10, 3x381 100 KA
<b>Temperature Ratings</b>	Storage: -40° to 80°C (-40° to 176° F) Operating: -25° to +70°C (-13° to 158° F)	<b>Terminal Markings</b>	According to CENELEC EN 50013
<b>Working Positions</b>	All working positions are allowed	<b>Connections</b>	Single screw with non-loosening plate clamp, 14AWG max., Tighten to 0.8Nm max
<b>Mechanical Life</b>	Pushbuttons, selector switches, joy stick switches: 1,000,000 operations Emergency mushrooms and push-push pushbuttons: 300,000 operations	<b>Contacts Operation</b>	Self-cleaning types EN01 (N.C.) EN 10 (N.O.) slow action, positive opening
<b>Positive Opening Operation</b>	(according to IEC 947-5-1) All functions incorporating an NC contact are positive opening operation	<b>Operation Frequency</b>	3600 operations per hour max.
		<b>Utilization Category</b>	AC15 (Control of AC electromagnetic loads) 24 volts AC at 10 amps 130 volts AC at 6.5 amps DC13 (Control of DC electromagnetic loads) 24 volts DC at 1.5 amps 110 volts DC at 0.5 amps

\*Note: Recommended, not supplied

To obtain the most current agency approval information, see the Agency Approval Checklist section on the specific part number's web page.