

# GCX Series 22mm Metal Pilot Lights and Key Switches

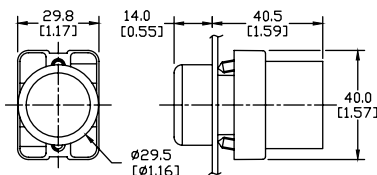

Dimensions: mm [inches]



## LED Pilot Light

- 12 models available
- Available in six colors
- 24V and 120V models
- LED lamps are included
- Accepts incandescent replacement bulbs

Part Number	Lamp Color	Price	Description	Replacement Incandescent Bulb	Replacement LED Lamp
<b>LED</b>					
<b>GCX1231-24L</b>	Red	\$14.50	22mm metal LED illuminated pilot light. <b>24VDC/VAC</b>	<b>ECX1902-5</b> 5/pk, 80mA	<b>ECX1911-2</b> 2/pk, 26mA
<b>GCX1231-120L</b>	Red	\$15.50	22mm metal LED illuminated pilot light. <b>120VDC/VAC</b>	<b>ECX1904-5</b> 5/pk, 20mA	<b>ECX1921-2</b> 2/pk, 5mA
<b>GCX1232-24L</b>	Green	\$14.50	22mm metal LED illuminated pilot light. <b>24VDC/VAC</b>	<b>ECX1902-5</b> 5/pk, 80mA	<b>ECX1912-2</b> 2/pk, 26mA
<b>GCX1232-120L</b>	Green	\$15.50	22mm metal LED illuminated pilot light. <b>120VDC/VAC</b>	<b>ECX1904-5</b> 5/pk, 20mA	<b>ECX1922-2</b> 2/pk, 5mA
<b>GCX1233-24L</b>	Yellow	\$14.50	22mm metal LED illuminated pilot light. <b>24VDC/VAC</b>	<b>ECX1902-5</b> 5/pk, 80mA	<b>ECX1913-2</b> 2/pk, 26mA
<b>GCX1233-120L</b>	Yellow	\$15.50	22mm metal LED illuminated pilot light. <b>120VDC/VAC</b>	<b>ECX1904-5</b> 5/pk, 20mA	<b>ECX1923-2</b> 2/pk, 5mA
<b>GCX1234-24L</b>	Blue	\$14.50	22mm metal LED illuminated pilot light. <b>24VDC/VAC</b>	<b>ECX1902-5</b> 5/pk, 80mA	<b>ECX1914-2</b> 2/pk, 26mA
<b>GCX1234-120L</b>	Blue	\$15.50	22mm metal LED illuminated pilot light. <b>120VDC/VAC</b>	<b>ECX1904-5</b> 5/pk, 20mA	<b>ECX1924-2</b> 2/pk, 5mA
<b>GCX1235-24L</b>	Clear	\$16.50	22mm metal LED illuminated pilot light. <b>24VDC/VAC</b>	<b>ECX1902-5</b> 5/pk, 80mA	<b>ECX1915-2</b> 2/pk, 26mA
<b>GCX1235-120L</b>	Clear	\$17.50	22mm metal LED illuminated pilot light. <b>120VDC/VAC</b>	<b>ECX1904-5</b> 5/pk, 20mA	<b>ECX1925-2</b> 2/pk, 5mA
<b>GCX1236-24L</b>	White	\$16.50	22mm metal LED illuminated pilot light. <b>24VDC/VAC</b>	<b>ECX1902-5</b> 5/pk, 80mA	<b>ECX1915-2</b> 2/pk, 26mA
<b>GCX1236-120L</b>	White	\$17.50	22mm metal LED illuminated pilot light. <b>120VDC/VAC</b>	<b>ECX1904-5</b> 5/pk, 20mA	<b>ECX1925-2</b> 2/pk, 5mA

## Key-operated selector switches

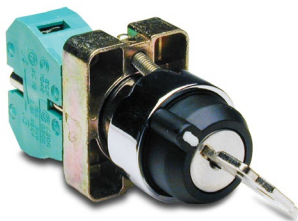

**GCX1420**  
(2-position maintained)

Part Number	Price	Description
<b>GCX1420</b>	\$18.00	22mm metal selector switch, key-operated, <b>two-position maintained</b> , key can be removed in all positions. <b>One N.O.</b> contact block. Replacement keys available
<b>GCX1430</b>	\$18.00	22mm metal selector switch, key-operated, <b>two-position spring-return from right</b> . <b>One N.O.</b> contact block. Replacement keys available
<b>GCX1470-22</b>	\$26.50	22mm metal selector switch, key-operated, <b>three-position maintained</b> , key can be removed in all positions. <b>Two N.O.</b> and <b>two N.C.</b> contact blocks. Replacement keys available

Dimensions: mm [inches]

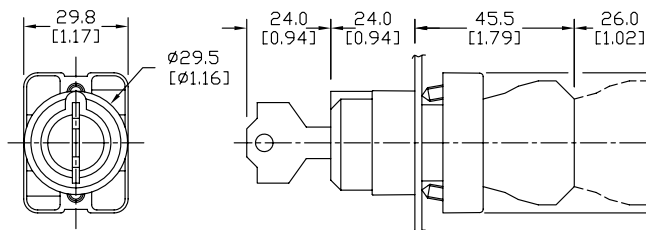

**Note:** Keyed switches come with two keys. All metal 22mm keyed switches are keyed the same. Replacement keys are available. Order part no. **ECX1067-2** (pkg. of 2). Keys for metal 22mm keyed switches are not compatible with Cutler-Hammer key switches.



**Note:** When using switches having two-deep contact blocks (such as, Model **GCX1470-22**) with the 22mm plastic enclosures, be sure to use enclosures that are 74mm deep. 51mm-deep enclosures are too shallow and the switch body will not fit.

**Note:** For contact closure sequence, refer to beginning of selector switches in this section.

For accessories, see 22mm Metal Pilot Device Accessories in this section.

# GCX Series 22mm Metal Pilot Devices Specifications

## Assembly information

These pushbuttons and indicator lights are supplied with the appropriate contact blocks, unless otherwise indicated. Use these drawings as a guide to make sure there is adequate clearance behind the panel.

### Pushbuttons and selector switches

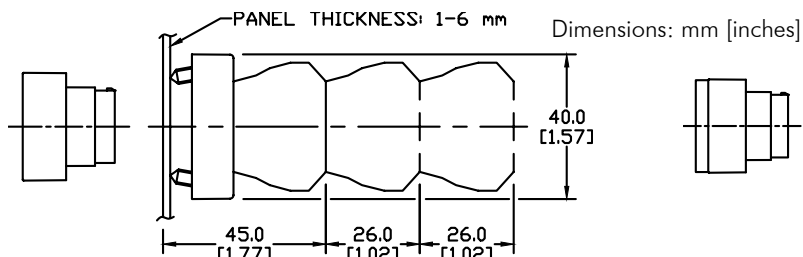

### Illuminated pushbuttons and selector switches/pilot lights

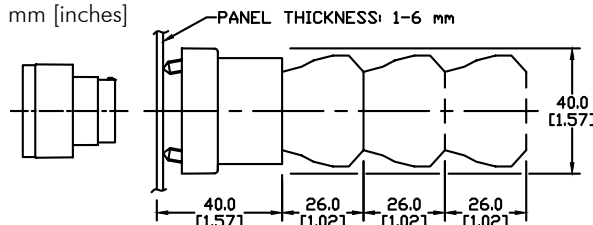

## Mounting

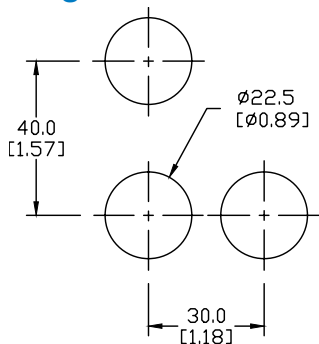

This layout is suitable if all switches are 230V or less and the same polarity.

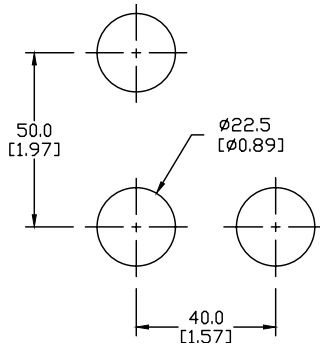

This layout is suitable if all switches are 400V or less and different polarity.

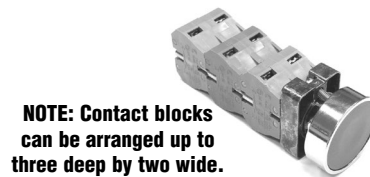

**NOTE: Contact blocks can be arranged up to three deep by two wide.**

## Typical Wiring

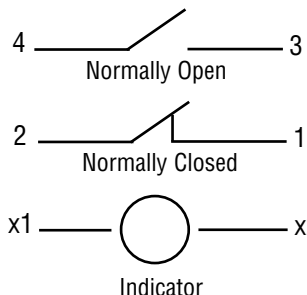

## Specifications

These specifications apply to all GCX and ECX 22 mm metal pushbuttons and switches.

Physical Specifications	
<b>Standards Reference</b>	CEI EN 60947-5-1, CSA C22-2 n.14
<b>Approvals</b>	CSA, IMQ (where specified), UL File E189258
<b>Enclosure Material</b>	Zn + Al + Mg alloy, chromium plated
<b>Contacts Material</b>	Silver
<b>Protection Degree</b>	IP 40 for GCX3151-24, GCX3151-120, GCX3153-24 and GCX3153-120. IP 65 for all others. (See Appendix of this catalog for explanation of IP ratings according to IEC 144 CEI 70-1.)
<b>Temperature Ratings</b>	Storage: -40° to 80°C (-40° to 176° F) Operating: -25° to +70°C (-13° to 158° F)
<b>Working Positions</b>	All working positions are allowed
<b>Mechanical Life</b>	Pushbuttons, selector switches: Joy stick switches: 1,000,000 operations Mushroom pushbuttons: 300,000 operations

Electrical Specifications	
<b>Rated Thermal Current (contact block)</b>	A300, Q300 (Refer to E22 Series mounting/contact rating section for details)
<b>Rated Insulation Voltage</b>	Ui 660V according to CEI EN 60947-5-1, 300V according to CSA C22-2 n.14
<b>Dielectric Strength</b>	3kV (1 second)
<b>Insulation Resistance</b>	2MΩ min. (500VDC)
<b>Initial Contact Resistance</b>	≤25mΩ
<b>Short-Circuit Protection*</b>	Cartridge fuses gl 10A - 500V 10,3x38l1 100kA
<b>Terminal Markings</b>	According to CENELEC EN 50013
<b>Connections</b>	Single screw with non-loosening plate clamp, 14AWG max.
<b>Contacts Operation</b>	Self-cleaning types EN01 (N.C.) EN 10 (N.O.) slow action, positive opening
<b>Operation Frequency</b>	3600 operations per hour max.
<b>Utilization Category</b>	<b>AC15</b> (Control of AC electromagnetic loads) 24 volts AC at 10 amps 130 volts AC at 6.5 amps <b>DC13</b> (Control of DC electromagnetic loads) 24 volts DC at 1.5 amps 110 volts DC at 0.5 amps

\*Note: Recommended, not supplied

# 22mm Metal Pilot Device Accessories

## Replacement incandescent bulbs



ECX1902-5

Replacement Incandescent Bulbs				
Part Number	Quantity	Price	Rating	Description
ECX1900-5	Pkg of 5 bulbs	\$8.50	6V@ 200mA , 1.2 watts	6V replacement bulb for 22mm switches and indicators. Miniature bayonet base T31/4
ECX1902-5	Pkg of 5 bulbs	\$8.50	24V@ 80mA 2 watts	24V replacement bulb for 22mm switches and indicators. Miniature bayonet base T31/4
ECX1904-5	Pkg of 5 bulbs	\$17.50	130V@20mA 2.6 watts	120V replacement bulb for 22mm switches and indicators. Miniature bayonet base T31/4

*Note: Bulb removal tool available. Order part number HT8LAMPTOOL.*

## Replacement LED lamps



ECX1915-2

Replacement LED Lamps					
Part Number	Color	Quantity	Price	Rating	Description
ECX1911-2	Red	Pkg of 2 LED lamps	\$15.50	24V@26mA 0.6 watts	LED replacement lamp for miniature bayonet bases Works with 22mm switches and indicators, but illumination will not be as even when used with the ECX 22mm indicators Note: <b>Will not replace</b> sealed Cutler-Hammer monoblock LED indicators.
ECX1912-2	Green		\$19.50		
ECX1913-2	Yellow		\$15.50		
ECX1914-2	Blue		\$21.00		
ECX1915-2	White		\$25.00		
ECX1921-2	Red		\$15.50	120V@5mA 0.6 watts	
ECX1922-2	Green		\$19.50		
ECX1923-2	Yellow		\$15.50		
ECX1924-2	Blue		\$21.00		
ECX1925-2	White		\$25.00		

## Hole plug



ECX1490

Hole Plug			
Part Number	Color	Price	Description
ECX1490	Black	\$2.75	Plastic hole plug for 22.5 mm openings in panels and enclosures; supplied with O-ring and mounting screw. Two plugs per package.

## Pilot Light replacement lens



PL1170PR-5

Pilot Light Replacement Lens				
Part Number	Lamp Color	Price	Description	Use with
PL1170PR-5	Red	\$6.00	22mm metallic series pilot light replacement lens, 5/pk	Part numbers starting with GCX123
PL1170PV-5	Green	\$6.00	22mm metallic series pilot light replacement lens, 5/pk	
PL1170PG-5	Yellow	\$6.00	22mm metallic series pilot light replacement lens, 5/pk	
PL1170PB-5	Blue	\$6.00	22mm metallic series pilot light replacement lens, 5/pk	
PL1170PN-5	Clear	\$6.00	22mm metallic series pilot light replacement lens, 5/pk	
PL1170PW-5	White	\$6.00	22mm metallic series pilot light replacement lens, 5/pk	

# 22mm Metal Pilot Device Accessories

## Protective covers for pushbuttons



ECX1703-5

Protective Covers for Pushbuttons				
Part Number	Color	Quantity	Price	Description
ECX1700-5	Black	Pkg of 5 Protective caps	\$6.50	Silicone protective covers for use with 22mm standard-size flush pushbuttons.
ECX1701-5	Red		\$6.50	
ECX1702-5	Green		\$6.50	
ECX1703-5	Yellow		\$6.50	
ECX1704-5	Blue		\$6.50	
ECX1705-5	Clear		\$6.50	
ECX1706-5	Clear		\$11.50	Clear silicone protective covers for use with 22mm illuminated and <b>extended pushbuttons only</b> . <b>Will not work</b> with Cutler-Hammer pushbuttons or 22mm mushroom pushbuttons.

## Replacement 22mm support base



ECX1029-2

Replacement 22mm Support Base			
Part Number	Quantity	Price	Description
ECX1029-2	Pkg of 1	\$6.00	22mm metal support base Note: This item is supplied as a replacement part and is not required with any switch assembly. <b>Will not work</b> with Cutler-Hammer 22mm switches sold by AUTOMATIONDIRECT

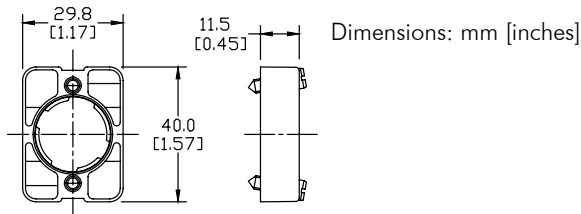

## Replacement contact blocks

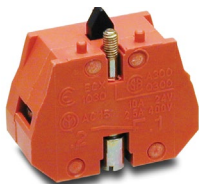

ECX1030-2

Replacement Contact Blocks				
Part Number	Quantity	Price	Contacts	Description
ECX1030-2	Pkg of 2	\$6.25	Red, normally-closed (N.C.)	Replacement contact block for 22mm pushbuttons and selector switches. Tightening Torque, terminal screw: 0.8Nm max mounting screw: 0.5Nm max
ECX1030-5	Pkg of 5	\$15.00	Green, normally-open (N.O.)	
ECX1040-2	Pkg of 2	\$6.25	Green, normally-open (N.O.)	Note: <b>Will not work</b> with Cutler-Hammer 22mm switches.
ECX1040-5	Pkg of 5	\$15.00	Brown, normally-open (N.O.), push-push	
ECX1042-2	Pkg of 2	\$6.25	Brown, normally-open (N.O.), push-push	Replacement normally open push-push contact blocks for 22mm pushbutton and selector switches, pack of 2. Note: Will not work with Cutler-Hammer 22mm switches.

Note: See electrical specifications on ECX Series 22mm Metal Pilot Devices Specifications page at beginning of this section.

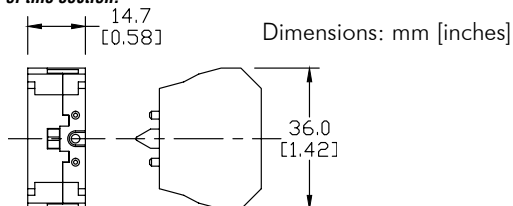

## Replacement keys



ECX1067-2

Replacement Keys			
Part Number	Quantity	Price	Description
ECX1067-2	Pkg of 2 sets (2 keys per set)	\$5.75	Replacement key for GCX series key-actuated selector switches, pack of 2 sets (2 keys each). NOTE: Will not work with Cutler-Hammer 22mm switches.

Note: All key-actuated 22mm metal selector switches are keyed alike.

# 22mm Metal Pilot Device Accessories

## EMERGENCY STOP legend plate



**ECX1651**

EMERGENCY STOP Legend Plate			
Part Number	Quantity	Price	Description
<b>ECX1651</b>	Pkg of 1	\$2.75	Oversize yellow circular EMERGENCY STOP legend plate for 22mm E-stop type mushroom pushbuttons, 60mm outside diameter.

## Knockout Punches



**109225**

Ruko's knockout punch hole-cutting tool includes punch, die and draw bolt (without ball bearing). Use for sheet steel, stainless-steel sheets, non-ferrous and light metals, and plastics up to 0.16" (8 ga.) thick.

Replacement bolts are offered in three of the most popular sizes.

**Note: Part number 109225 is recommended when punching holes for 22mm pilot devices.**

## Two-position short lever operator



**GR1172PR-5**

Short Lever Replacement Operator				
Part Number	Lamp Color	Price	2-Position	Use with
<b>GR1172PR-5</b>	Red	\$14.50	22mm 2-position selector switch illuminated short lever replacement operator, 5/pk	Part numbers starting with GCX124, GCX125, GCX324, GCX325
<b>GR1172PV-5</b>	Green	\$14.50	22mm 2-position selector switch illuminated short lever replacement operator, 5/pk	
<b>GR1172PG-5</b>	Yellow	\$14.50	22mm 2-position selector switch illuminated short lever replacement operator, 5/pk	
<b>GR1172PB-5</b>	Blue	\$14.50	22mm 2-position selector switch illuminated short lever replacement operator, 5/pk	
<b>GR1172PN-5</b>	Clear	\$14.50	22mm 2-position selector switch illuminated short lever replacement operator, 5/pk	

## Three-position short lever operator



**GR1288PR-5**

Short Lever Replacement Operator				
Part Number	Lamp Color	Price	3-Position	Use with
<b>GR1288PR-5</b>	Red	\$14.50	22mm 3-position selector switch illuminated short lever replacement operator, 5/pk	Part numbers starting with GCX126, GCX128, GCX326, GCX328
<b>GR1288PV-5</b>	Green	\$14.50	22mm 3-position selector switch illuminated short lever replacement operator, 5/pk	
<b>GR1288PG-5</b>	Yellow	\$14.50	22mm 3-position selector switch illuminated short lever replacement operator, 5/pk	
<b>GR1288PB-5</b>	Blue	\$14.50	22mm 3-position selector switch illuminated short lever replacement operator, 5/pk	
<b>GR1288PN-5</b>	Clear	\$14.50	22mm 3-position selector switch illuminated short lever replacement operator, 5/pk	

# 22mm Metal Pilot Device Accessories

## Mushroom switch replacement operator



**PL1298P-5**

Mushroom Switch Replacement Operator				
Part Number	Lamp Color	Price	Description	Use with
<b>PL1171PR-5</b>	Red	\$6.25	22mm, illuminated <b>momentary</b> Mushroom switch replacement operator, red, 5/pk	Part numbers starting with GCX1221, GCX3221 mushroom-style illuminated pushbuttons
<b>PL1298P-5</b>	Red	\$6.25	22mm illuminated <b>twist-to-release</b> mushroom switch replacement operator, red, 5/pk	Part numbers starting with GCX1226, GCX3226 mushroom-style illuminated pushbuttons

## Flush pushbutton replacement operator



**GR1168PR-5**

Flush Pushbutton Replacement Operator				
Part Number	Lamp Color	Price	Description	Use with
<b>GR1168PR-5</b>	Red	\$8.00	22mm illuminated flush pushbutton replacement operator, 5/pk	Part numbers starting with GCX119, GCX120 GCX319, GCX320
<b>GR1168PV-5</b>	Green	\$8.00	22mm illuminated flush pushbutton replacement operator, 5/pk	
<b>GR1168PG-5</b>	Yellow	\$8.00	22mm illuminated flush pushbutton replacement operator, 5/pk	
<b>GR1168PB-5</b>	Blue	\$8.00	22mm illuminated flush pushbutton replacement operator, 5/pk	
<b>GR1168PN-5</b>	Clear	\$8.00	22mm illuminated flush pushbutton replacement operator, 5/pk	
<b>GR1168PW-5</b>	White	\$8.00	22mm illuminated flush pushbutton replacement operator, 5/pk	

## Extended pushbutton replacement operator



**PL1308PR-5**

Extended Pushbutton Replacement Operator				
Part Number	Lamp Color	Price	Description	Use with
<b>PL1308PR-5</b>	Red	\$6.00	22mm illuminated extended pushbutton, replacement operator, 5/pk	Part numbers starting with GCX121, GCX321
<b>PL1308PV-5</b>	Green	\$6.00	22mm illuminated extended pushbutton, replacement operator, 5/pk	
<b>PL1308PG-5</b>	Yellow	\$6.00	22mm illuminated extended pushbutton, replacement operator, 5/pk	
<b>PL1308PB-5</b>	Blue	\$6.00	22mm illuminated extended pushbutton, replacement operator, 5/pk	
<b>PL1308PN-5</b>	Clear	\$6.00	22mm illuminated extended pushbutton, replacement operator, 5/pk	
<b>PL1308PW-5</b>	White	\$6.00	22mm illuminated extended pushbutton, replacement operator, 5/pk	



# E22 Series Cross-reference Tables

<b>Pushbutton, Indicator Light, and Selector Switch Cross Reference</b>				
<b>Cutler-Hammer</b>	<b>Allen-Bradley</b>	<b>Telemecanique XB2B (chrome bezel) XA2B (black bezel)</b>	<b>GE C-2000</b>	<b>Siemens</b>
<b>Non-Illuminated Pushbuttons</b>				
E22PB1A	800EPF2 800E3LX10	ZA2BA2 ZA2BZ101	P9XPNG10N0	3SB1000-0AB01 3SB02-CBH 3SB1400-0B
E22PB3A	800EPF3 800E3LX10	ZA2BA3 ZA2BZ101	P9XPNVG10N0	3SB1000-0AE01 3SB02-CBH 3SB1400-0B
E22EB2B	800EPE4 800E3LX01	ZA2BL4 ZA2BZ102	P9XPNRS20N0	3SB1000-0LC01 3SB02-CBH 3SB1400-0B
E22ASB204	ENCLSR: 800E-2P 800EP-F3 800E-2LX10 800EP-E4 800E-2LX01 800E-34BE208 800E-34R212	XALB211 Both flush - stop is not extended	P9CPNRSN20N0 P9CPNVGN10N0 P9EPB02 P9AEPN201 P9AEPN202	3SB02-S21
<b>Illuminated Pushbuttons</b>				
E22TB2X4B	800EPL4 800E3DL3 800E3X01	ZA2BW14 ZA2BW06224	P9XPLRSDN12NADI	3SB1001-0LC01 3SB02-CBH 3SB1400-0C 3SB1400-2H
E22TB3X4A	800EPL3 800E3DL3 800E3X10	ZA2B213 AZ2B206124	P9XPLVSDN12NADI	3SB1001-0LE01 3SB02-CBH 3SB1400-0B 3SB1440-2H
E22TB9X4A	800EPL5 800E3DL3 800E3X10	ZA2BW15 ZA2BW06124	P9XPLASDN12NADI	3SB1001-0LD01 3SB02-CBH 3SB1400-0B 3SB1400-2H
E22TB2X10B	800EPL4 800E2RL5 800E3X01	ZA2BW14 ZA2BW062120	P9XPLRSB P9PRNVJ P9PDNVD	3SB1001-0LC01 3SB02-CBH 3SB1400-0C
E22TB3X10A	800EPL3 800E2RL5 800E3X10	ZA2BW13 ZA2BW061120	P9XPLVSD P9PRNVJ P9PDNVD	3SB02-UPR1P 3SB1910-0DE 3SB1400-0B
E22TB9X10A	800DPLE5 800E2RL5 800E3X10	ZA2BW15 ZA2B2061120	P9XPLASD P9PRNVJ P9PDNVD	3SB02-UPR1P 3SB1910-0DD 3SB1400-0B

# GCX Series 22mm Metal Pilot Devices

## Features

**Any combination of contact blocks is allowed, up to a total of six (two blocks wide and three blocks deep)**

**Secure mounting method eliminates twisting in mounting hole**

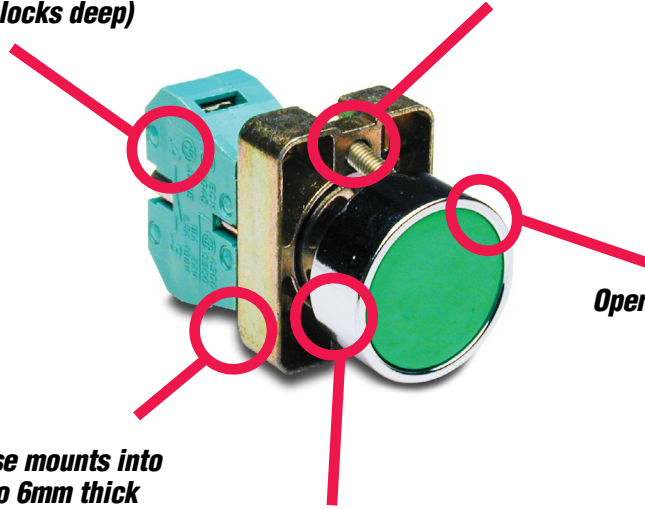

**Operators are protected to IP65**

**Support base mounts into panels up to 6mm thick**

**Chrome-plated alloy bezel is not only corrosion-resistant, but also attractive**

## Easy installation

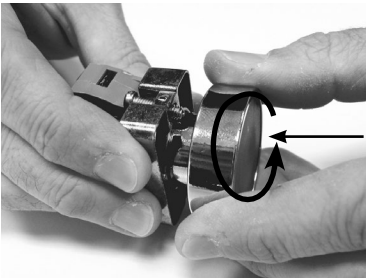

To remove operator, press toward support base and twist counterclockwise.



To install switch, place support base against rear of panel (not shown here), insert the operator and twist clockwise until it clicks into place. Carefully tighten the securing screws. Do not over-tighten.

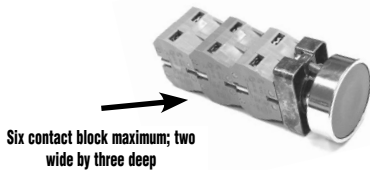

Six contact block maximum; two wide by three deep

**Self-cleaning silver contacts provide reliable, low-energy switching**

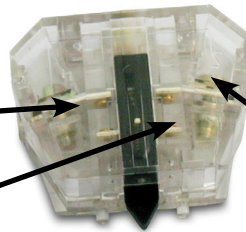

**Pressure plate wiring terminals for easy, secure wiring, accepting up to 14 AWG wire**

**Contacts rated A300**  
(Refer to E22 Series mounting/contact rating section for details)

Clear contact block for illustration purposes. Clear contact blocks are not available for sale from AutomationDirect.

Minimum current rating  
15mA @ 24vdc

**All indicators offer side wire entry with back screw terminals for easy wiring**

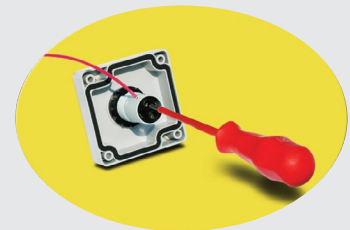



# GCX Series 22mm Plastic Pilot Devices Specifications

## Assembly information

These pushbuttons and indicator lights are supplied with the appropriate contact blocks, unless otherwise indicated. Use these drawings as a guide to make sure there is adequate clearance behind the panel.

### Pushbuttons and selector switches

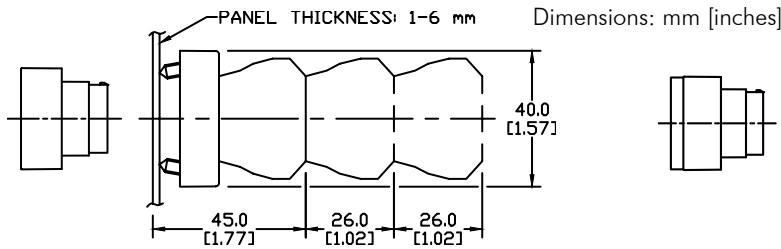

### Illuminated pushbuttons and selector switches/indicator lights

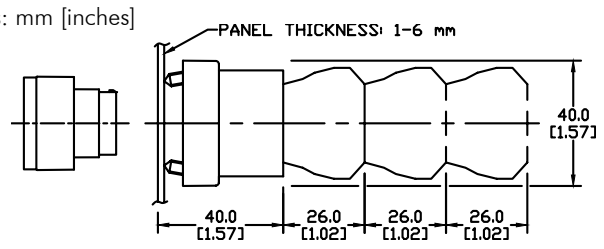

## Mounting

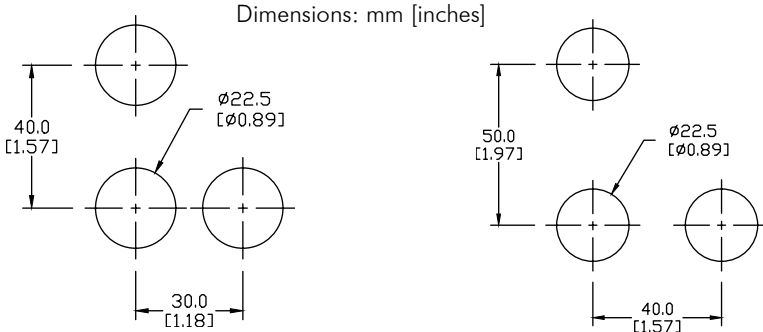

This layout is suitable if all switches are 230V or less and the same polarity.

This layout is suitable if all switches are 400V or less and different polarity.

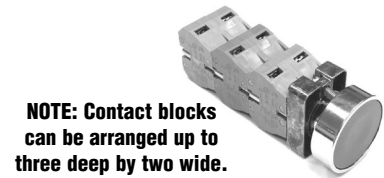

**NOTE: Contact blocks can be arranged up to three deep by two wide.**

### Typical Wiring

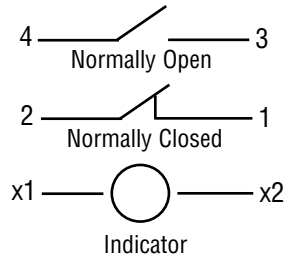

## Specifications

These specifications apply to all the GCX and ECX 22mm plastic pushbuttons and switches.

Physical Specifications		Electrical Specifications	
<b>Standards Reference</b>	CEI EN 60947-5-1, CSA C22-2 n.14	<b>Rated Thermal Current (contact block)</b>	A300, Q300 (Refer to E22 Series mounting/contact rating section for details)
<b>Approvals</b>	UL File E189258, IMQ (where specified)	<b>Rated Insulation Voltage</b>	Ui 660V according to CEI EN 60947-5-1, 300V according to CSA C22-2 n.14 and UL 508
<b>Enclosure Material</b>	Fiberglass reinforced thermoplastic	<b>Dielectric Strength</b>	3kV (1 second)
<b>Contacts Material</b>	Silver	<b>Insulation Resistance</b>	2MΩ min. (500VDC)
<b>Protection Degree</b>	IP 40 for GCX3151-24, GCX3151-120, GCX3153-24 and GCX3153-120. IP 65 for all others. (See Appendix of this catalog for explanation of IP ratings according to IEC 144 CEI 70-1.)	<b>Initial Contact Resistance</b>	≤25mΩ
<b>Electric Shock Protection</b>	IEC 536, Class II	<b>Short-Circuit Protection*</b>	Cartridge fuses gl 10 A-500V 10, 3x381 100 KA
<b>Temperature Ratings</b>	Storage: -40° to 80°C (-40° to 176° F) Operating: -25° to +70°C (-13° to 158° F)	<b>Terminal Markings</b>	According to CENELEC EN 50013
<b>Working Positions</b>	All working positions are allowed	<b>Connections</b>	Single screw with non-loosening plate clamp, 14AWG max., Tighten to 0.8Nm max
<b>Mechanical Life</b>	Pushbuttons, selector switches, joy stick switches: 1,000,000 operations Emergency mushrooms and push-push pushbuttons: 300,000 operations	<b>Contacts Operation</b>	Self-cleaning types EN01 (N.C.) EN 10 (N.O.) slow action, positive opening
<b>Positive Opening Operation</b>	(according to IEC 947-5-1) All functions incorporating an NC contact are positive opening operation	<b>Operation Frequency</b>	3600 operations per hour max.
		<b>Utilization Category</b>	AC15 (Control of AC electromagnetic loads) 24 volts AC at 10 amps 130 volts AC at 6.5 amps DC13 (Control of DC electromagnetic loads) 24 volts DC at 1.5 amps 110 volts DC at 0.5 amps

\*Note: Recommended, not supplied

To obtain the most current agency approval information, see the Agency Approval Checklist section on the specific part number's web page.