

CLICK PLUS Option Slot Module Specifications

C2-08D2-6V

\$90.00

4 DC Input / 4 Sourcing DC Output
4 Analog Voltage Input
2 Analog Voltage Output
Option Slot I/O Module



NOTE: Use this module and a CLICK PLUS CPU as a comparable replacement for the existing [C0-12DD2E-2-D](#) PLC.

Wiring Diagram

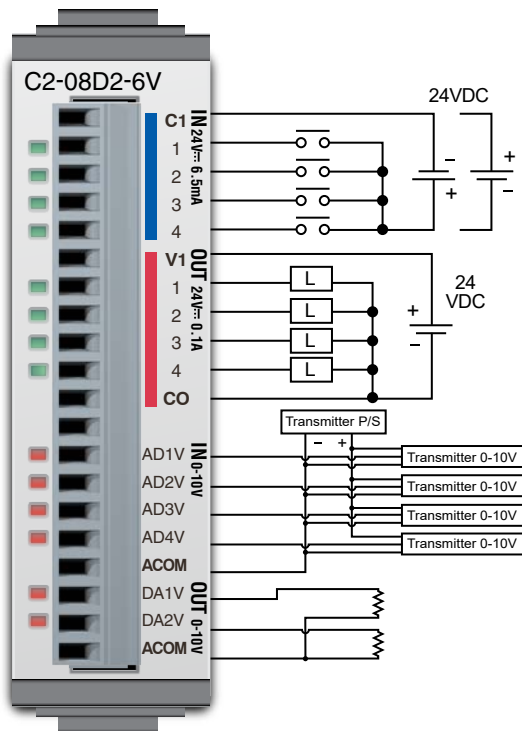

← **See Discrete I/O Specifications**
Inputs (X1 – X4) High-Speed

← **See Discrete I/O Specifications**
Outputs (Y1 – Y4)
Y1 and Y3 Outputs High-Speed

← **See Analog I/O Specifications**
Voltage Inputs (AD1V – AD4V)

← **See Analog I/O Specifications**
Voltage Outputs (DA1V – DA2V)



NOTE: There are no **ZIPLink** pre-wired PLC connection cables and modules for the Analog Option Slot Modules (cannot mix discrete I/O and analog I/O signals in a **ZIPLink** cable).

| General Specifications | |
|-------------------------------------|--------------------------|
| Current Consumption at 24VDC | 80mA max (All Points On) |
| Terminal Block Replacement Part No. | C0-16TB |
| Drawing Link | PDF |
| Weight | 48g |

CLICK PLUS Option Slot Module Specifications

C2-08D2-6V (cont'd)

X1 - X4 (High-Speed)

| Discrete I/O Specifications - Inputs | |
|--------------------------------------|----------------------------------|
| Inputs per Module | 4 (Sink/Source) |
| Operating Voltage Range | 24VDC |
| Input Voltage Range | 21.6–26.4 VDC |
| Input Current | Typ 6.5 mA @ 24VDC |
| Maximum Input Current | 7mA @ 26.4 VDC |
| Input Impedance | 3.9 kΩ @ 24VDC |
| Input Frequency (Max) | X1-X4: 100kHz (3m cable) |
| ON Voltage Level | > 19VDC |
| OFF Voltage Level | < 2VDC |
| Minimum ON Current | 4.5 mA |
| Maximum OFF Current | 0.5 mA |
| OFF to ON Response | Typ 3μs, Max 5μs |
| ON to OFF Response | Typ 1μs, Max 3μs |
| Status Indicators | Logic Side (4 points, green LED) |
| Commons | 1 (4 points/common) |

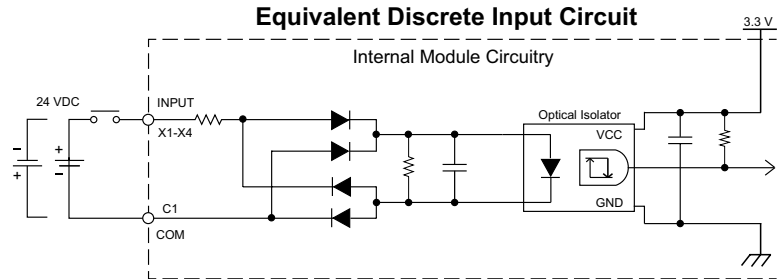

| Maximum Number of High Speed Counters | |
|---------------------------------------|---|
| Up | 4 |
| Down | 4 |
| Up/Down | 2 |
| Pulse/Direction | 2 |
| Quadrature A-B | 2 |
| Quadrature A-B+Z | 1 |

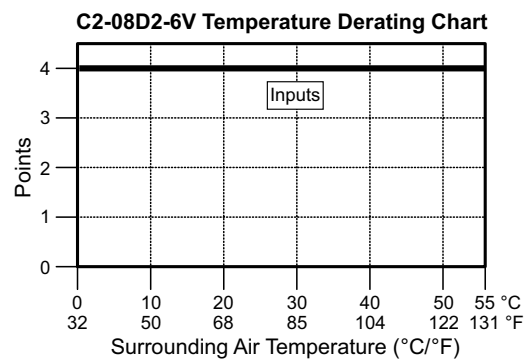

Y1 - Y4

| Discrete I/O Specifications - Outputs | |
|---------------------------------------|--|
| Outputs per Module | 4 (Source) |
| Output Voltage Range | 19.2–30 VDC |
| Maximum Output Current | 0.1 A/point , 0.4 A/common CO |
| Minimum Output Current | 0.2 mA |
| Maximum Leakage Current | 0.1 mA @ 30VDC |
| On Voltage Drop | 0.5 VDC@ 0.1 A |
| Maximum Inrush Current | 150mA for 10ms |
| Output Frequency (Max) | Y1, Y3: 100kHz (3m cable) |
| OFF to ON Response | < 5μs |
| ON to OFF Response | < 5μs |
| Status Indicators | Logic Side (4 points, red LED) |
| Commons | 1 (4 points/common) |
| External DC Power Required | 20–28 VDC Maximum @ 60mA (All points on) |

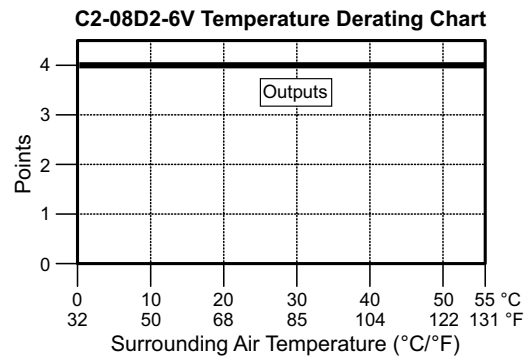
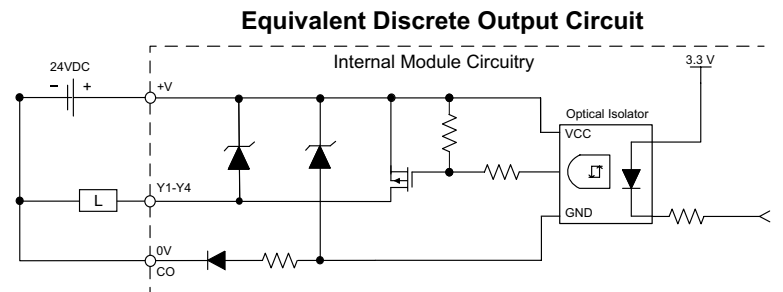

| Maximum Number of High Speed Outputs | |
|--------------------------------------|---|
| Pulse Train | 2 |
| Pulse Width Modulation | 2 |

CLICK PLUS Option Slot Module Specifications

C2-08D2-6V (cont'd)

AD1V - AD4V

| Analog Specifications - Voltage Input | |
|---------------------------------------|-------------------------------------|
| Inputs per Module | 4 (voltage) |
| Input Range | 0–10 VDC |
| Resolution | 12-bit |
| Conversion Time | 50ms |
| Input Impedance | 40k Ω |
| Input Stability | ± 2 LSB maximum |
| Full-Scale Calibration Error | $\pm 2\%$ maximum |
| Offset Calibration Error | ± 25 mV maximum |
| Accuracy vs. Temperature Error | ± 100 ppm/ $^{\circ}$ C maximum |

Analog Voltage Input Circuit

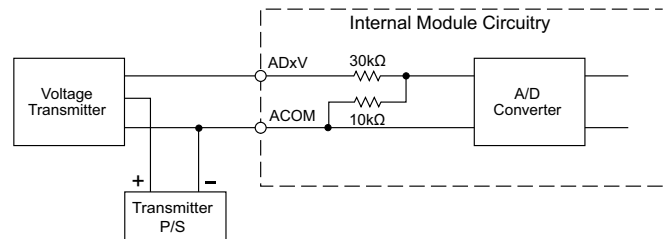

DA1V - DA2V

| Analog Specifications - Voltage Output | |
|--|---|
| Outputs per Module | 2 (voltage) |
| Output Range | 0–10 VDC |
| Resolution | 12-bit |
| Conversion Time | 1ms |
| Load Impedance | 4k Ω minimum (output current 2.5 mA maximum) |
| Full-Scale Calibration Error | $\pm 2\%$ maximum |
| Offset Calibration Error | ± 25 mV maximum |
| Accuracy vs. Temperature Error | ± 100 ppm/ $^{\circ}$ C maximum |

Analog Voltage Output Circuit

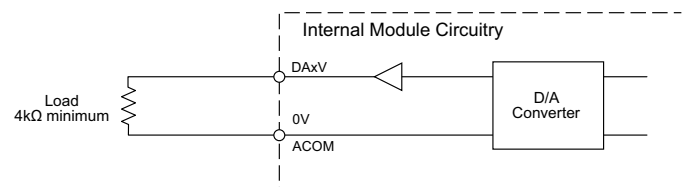

CLICK PLUS Option Slot Module Specifications

General Specifications For All CLICK PLUS Option Slot Modules

These general specifications apply to all CLICK PLUS Option Slot Modules. Please refer to the appropriate I/O temperature derating charts under the Option Slot module and Stackable I/O module specifications to determine the best operating conditions based on the ambient temperature of your particular application.

| Option Slot Module General Specifications | |
|---|--|
| Operating Temperature | 32°F to 131°F [0°C to 55°C] |
| Storage Temperature | -4°F to 158°F [-20°C to 70°C] IEC 60068-2-1 (Test Ab, Cold) IEC 60068-2-2 (Test Bb, Dry Heat) IEC 60068-2-14 (Test Na, Thermal Shock) |
| Ambient Humidity | 30% to 95% relative humidity (non-condensing) |
| Environmental Air | No corrosive gases. Environmental pollution level is 2 (UL840) |
| Environment | For Indoor Use Only |
| Vibration | IEC60068-2-6 (Test Fc) 5-9Hz:3.5mm amplitude, 9-150Hz 1.0G 10 sweep cycles per axis on each of 3 mutually perpendicular axes. |
| Shock | IEC60068-2-27 (Test Ea) 15G peak, 11ms duration, 3 shocks in each direction per axis, on 3 mutually perpendicular axes. |
| Noise Immunity | <EN61131-2> EN61000-4-2 (ESD) EN61000-4-3 (RFI) EN61000-4-4 (FTB) EN61000-4-6 (Conducted) EN61000-4-8 (Power frequency magnetic field immunity) <Local Test> Impulse Immunity : 1000V @ 1uS pulse |
| Emissions | EN55011 Class A (Radiated RF emission) |
| Agency Approvals | UL61010 (File No. E157382, E316037); CE (EN61131-2); CUL Canadian C22.2 |
| Other | RoHS 2011/65/EU Amendment (EU)2015/863 |

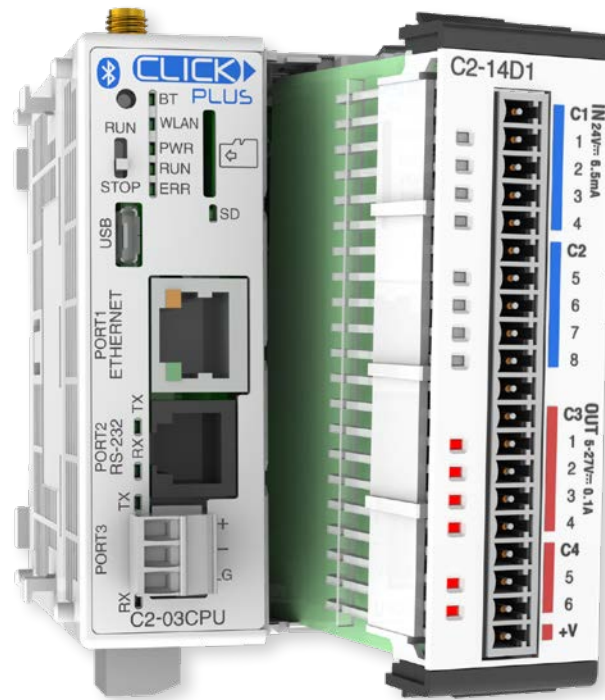

CLICK PLUS PLC Specifications

CLICK PLUS PLC Hardware/Software Compatibility

The table below shows the minimum software and hardware versions required for the CLICK PLUS PLCs and Option Slot Modules. The CLICK PLUS PLC can also utilize the CLICK Stackable I/O Modules, as any software and hardware version compatible with CLICK PLUS is also compatible with the CLICK Stackable I/O Modules.

| CLICK PLUS PLC Features Software Compatibility | | | | | | |
|--|-----------------------------|--------------------------------|--------------------|---------------------|-------------|----------------------------|
| Device Type | Part Number | Minimum CLICK Software Version | | | | |
| | | Hardware | High-Speed Inputs* | High-Speed Outputs* | EtherNet/IP | PID, DHCP, DNS, SNTP, MQTT |
| CLICK PLUS CPU | C2-01CPU | v3.00 | v3.00 | v3.30 | v3.00 | v3.00 |
| | C2-02CPU | | | | N/A | |
| | C2-03CPU | | | | v3.00 | |
| | C2-01CPU-2 | v3.20 | v3.20 | v3.20 | v3.20 | v3.20 |
| | C2-02CPU-2 | | | | N/A | |
| | C2-03CPU-2 | | | | v3.20 | |
| Option Slot I/O Modules | C2-14D1 | v3.00 | v3.00 | v3.30 | N/A | N/A |
| | C2-14D2 | | | N/A | | |
| | C2-14DR | | | | | |
| | C2-14AR | | | | | |
| | C2-08D1-4VC | v3.00 | v3.00 | v3.30 | N/A | N/A |
| | C2-08D2-4VC | | | N/A | | |
| | C2-08DR-4VC | | | | | |
| | C2-08AR-4VC | | | | | |
| | C2-08D1-6C | v3.00 | v3.00 | v3.30 | N/A | N/A |
| | C2-08D2-6C | | | N/A | | |
| | C2-08DR-6C | | | | | |
| | C2-08AR-6C | | | | | |
| | C2-08D1-6V | v3.00 | v3.00 | v3.30 | N/A | N/A |
| | C2-08D2-6V | | | N/A | | |
| | C2-08DR-6V | | | | | |
| | C2-08AR-6V | | | | | |
| Option Slot Intelligent Modules | C2-DCM | v3.20 | N/A | N/A | N/A | N/A |

* High-speed Inputs and Outputs are only available when the Option Slot I/O Module is installed in Slot 0.

Accessories

C2-USER-M **\$0.00** **CLICK PLUS PLC Hardware User Manual**

Manual covers all CLICK PLUS PLC and I/O module installation and wiring, specifications, error codes and troubleshooting guide. The CLICK PLUS PLC Hardware User Manual can be downloaded free at the AutomationDirect Web site; www.AutomationDirect.com



C0-USER-M **\$0.00** **CLICK PLC Hardware User Manual**

Manual covers all CLICK PLC and I/O module installation and wiring, specifications, error codes and troubleshooting guide. The CLICK PLC Hardware User Manual can be downloaded free at the AutomationDirect Web site; www.AutomationDirect.com



C0-PGMSW **\$12.00** **Programming Software USB**

The programming software can be downloaded free at the AutomationDirect Web site, or the USB can be purchased from the AutomationDirect online Web store. www.AutomationDirect.com



EA-MG-PGM-CBL **\$52.00** **PC to Panel Programming Cable Assembly for C-more Micro-Graphic Panels and CLICK/CLICK PLUS PLCs**

The 6-ft cable assembly connects a personal computer to any **C-more** Micro-Graphic panel, CLICK PLC, or select CLICK PLUS PLC for setup and programming.

Note: This cable assembly uses the PC's USB port and converts the signals to serial transmissions. The USB port supplies 5VDC to the Micro-Graphic panel for configuration operations.

Assembly includes standard USB A-type connector to B-type connector cable, custom converter, and an RS232C cable with an RJ12 modular connector on each end.



USB-CBL-AMICB6 **\$5.25** **USB A to USB microB Programming Cable Assembly (CLICK PLUS Only)**

Programming cable, USB A to USB microB, 6ft (1.83 m) length. For use with CLICK PLUS PLCs and most USB devices. The USB port supplies 5VDC to the CLICK PLUS CPU for programming.



D2-DSCBL **\$35.00** **Programming Cable for CLICK/CLICK PLUS and DirectLOGIC PLCs**

12ft. (3.66 m) RS232 shielded PC programming cable for CLICK, select CLICK PLUS PLCs, DL05, DL06, DL105, DL205, D3-350, D4-450, D4-454, and Do-more H2 and T1H series CPUs. 9-pin D-shell female connector to an RJ12 6P6C connector.



Note: If your PC has a USB port but does not have a serial port, you must use programming cable [EA-MG-PGM-CBL](#) to connect to CLICK PLCs. For CLICK PLUS PLCs, you may also use [USB-CBL-AMICB6](#)

C0-3TB **\$10.00** **Spare 3-Pole Terminal Block**

Replacement 3-pole terminal block for the 3-wire RS-485 Port 3 on CLICK Standard and Analog PLCs as well as the CLICK PLUS [C2-03CPU](#). Sold in packs of 2.



C0-4TB **\$10.00** **Spare 24VDC Power Terminal Block**

Replacement terminal block for the 24VDC supply power to the PLC. Sold in packs of 2.

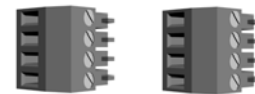

C0-8TB **\$16.50** **Spare 8-Point I/O Terminal Block**

Replacement terminal block for the 8-point I/O modules. Sold in packs of 2.

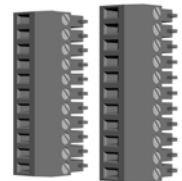

C0-8TB-1 **\$19.50** **Spare 13-Point I/O Terminal Block**

Replacement terminal block for the 8-point I/O relay modules. Sold in packs of 2.



C0-16TB **\$23.00** **Spare 16-Point I/O Terminal Block**

Replacement terminal block for the 16-point I/O modules and PLC built-in I/O. Sold in packs of 2.

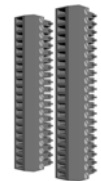

C2-6TB **\$16.50** **Spare 6-pt Terminal Block**

Replacement terminal block for the C2-DCM serial ports. Sold in packs of 2.

