

CLICK PLUS Option Slot Module Specifications

C2-08D2-4VC

\$90.00

**4 DC Input / 4 Sourcing DC Output
2 Analog Voltage/Current Input
2 Analog Voltage/Current Output
Option Slot I/O Module**



NOTE: Use this module and a CLICK PLUS CPU as a comparable replacement for the existing C0-12DD2E-D PLC.

Wiring Diagram

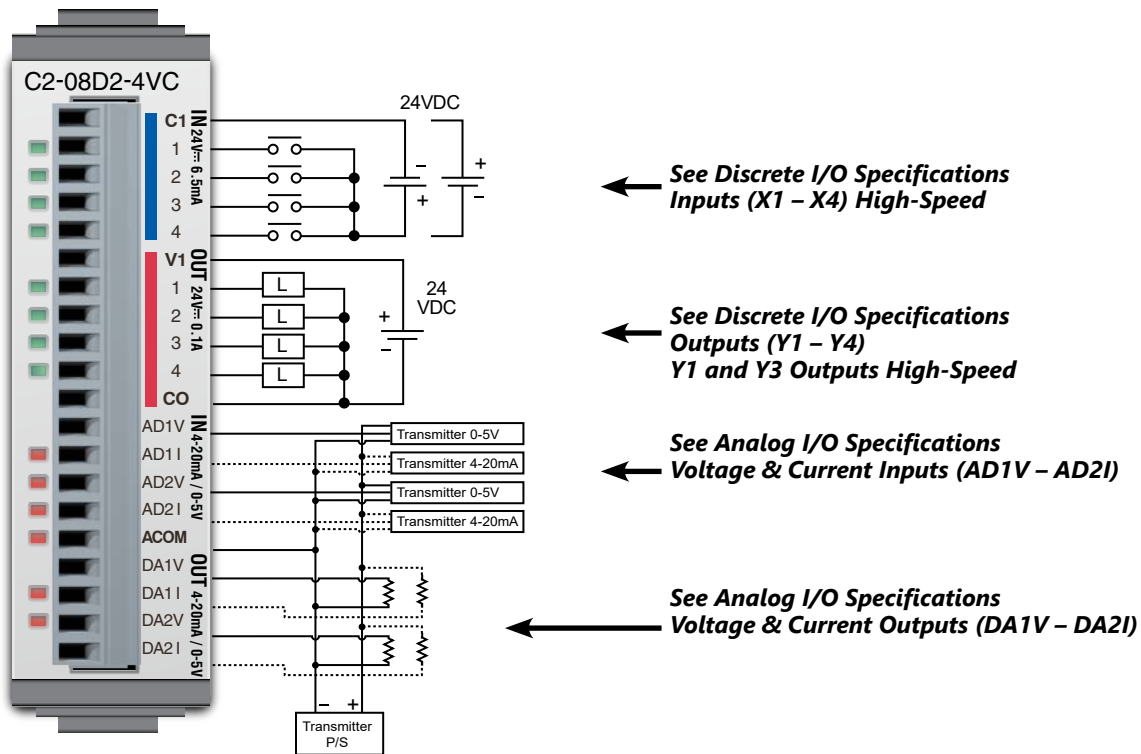

NOTE: There are no **ZIPLink** pre-wired PLC connection cables and modules for the Analog Option Slot Modules (cannot mix discrete I/O and analog I/O signals in a **ZIPLink** cable).

General Specifications	
Current Consumption at 24VDC	80mA max (All Points On)
Terminal Block Replacement Part No.	C0-16TB
Drawing Link	PDF
Weight	48g

CLICK PLUS Option Slot Module Specifications

C2-08D2-4VC (cont'd)

X1 - X4 (High-Speed)

Discrete I/O Specifications - Inputs	
Inputs per Module	4 (Sink/Source)
Operating Voltage Range	24VDC
Input Voltage Range	21.6–26.4 VDC
Input Current	Typ 6.5 mA @ 24VDC
Maximum Input Current	7mA @ 26.4 VDC
Input Impedance	3.9 kΩ @ 24VDC
Input Frequency (Max)	X1-X4: 100kHz (3m cable)
ON Voltage Level	> 19VDC
OFF Voltage Level	< 2VDC
Minimum ON Current	4.5 mA
Maximum OFF Current	0.5 mA
OFF to ON Response	Typ 3μs, Max 5μs
ON to OFF Response	Typ 1μs, Max 3μs
Status Indicators	Logic Side (4 points, green LED)
Commons	1 (4 points/common)

Maximum Number of High Speed Counters	
Up	4
Down	4
Up/Down	2
Pulse/Direction	2
Quadrature A-B	2
Quadrature A-B+Z	1

Y1 - Y4

Discrete I/O Specifications - Outputs	
Outputs per Module	4 (Source)
Operating Voltage Range	24VDC
Output Voltage Range	19.2–30 VDC
Maximum Output Current	0.1 A/point, 0.4 A/common
Minimum Output Current	0.2 mA
Maximum Leakage Current	0.1 mA @ 30VDC
On Voltage Drop	0.5 VDC @ 0.1 A
Maximum Inrush Current	150mA for 10ms
Output Frequency (Max)	Y1, Y3: 100kHz (3m cable)
OFF to ON Response	< 5μs
ON to OFF Response	< 5μs
Status Indicators	Logic Side (4 points, red LED)
Commons	1 (4 pts or 1 pt/common)

Maximum Number of High Speed Outputs	
Pulse Train	2
Pulse Width Modulation	2

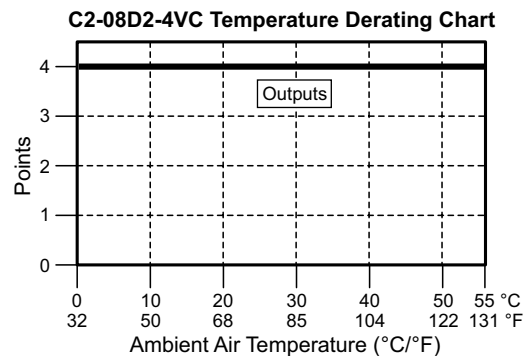
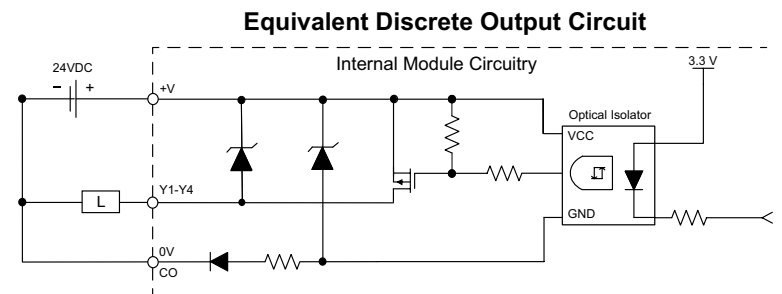
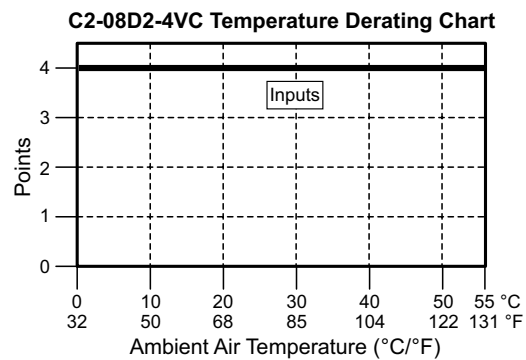
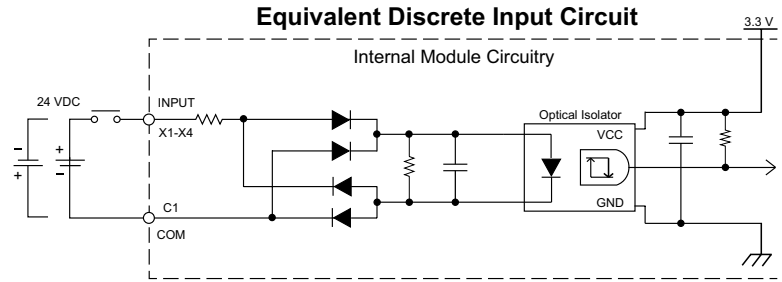

CLICK PLUS Option Slot Module Specifications

C2-08D2-4VC (cont'd)

AD1V - AD2V

Analog Specifications - Voltage Input	
Inputs per Module	2 (voltage/current selectable)
Input Range	0–5 VDC
Resolution	12-bit
Conversion Time	50ms
Input Impedance	20kΩ
Input Stability	±2 LSB maximum
Full-Scale Calibration Error	±2% maximum
Offset Calibration Error	±25mV maximum
Accuracy vs. Temperature Error	±100ppm/°C maximum

Analog Voltage Input Circuit

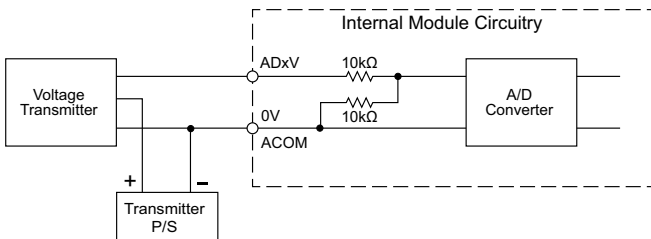

AD1I - AD2I

Analog Specifications - Current Input	
Inputs per Module	2 (voltage/current selectable)
Input Range	4–20 mA (sink)
Resolution	12-bit
Conversion Time	50ms
Input Impedance	125Ω
Input Stability	±2 LSB maximum
Full-Scale Calibration Error	±2% maximum
Offset Calibration Error	±0.1 mA maximum
Accuracy vs. Temperature Error	±100ppm/°C maximum

Analog Current Input Circuit

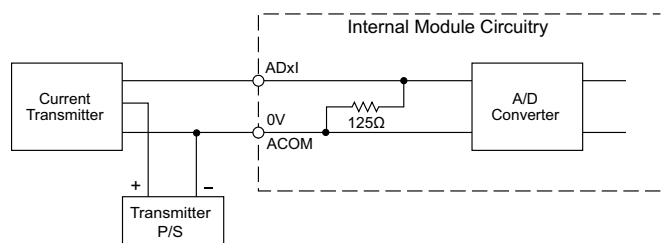

DA1V - DA2V

Analog Specifications - Voltage Output	
Outputs per Module	2 (voltage/current selectable)
Output Range	0–5 VDC
Resolution	12-bit
Conversion Time	1ms
Load Impedance	2kΩ minimum (output current 2.5 mA maximum)
Full-Scale Calibration Error	±2% maximum
Offset Calibration Error	±25mV maximum
Accuracy vs. Temperature Error	±100ppm/°C maximum

Analog Voltage Output Circuit

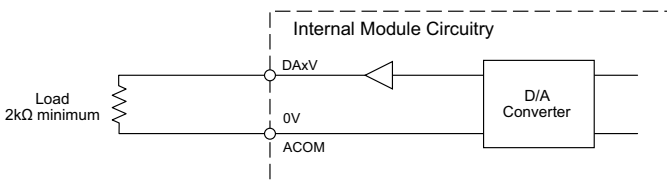

DA1I - DA2I

Analog Specifications - Current Output	
Outputs per Module	2 (voltage/current selectable)
Output Range	4–20 mA (sink)
Resolution	12-bit
Conversion Time	1ms
Loop Supply Voltage	DC 18–30 V
Load Impedance	250Ω Load Power Supply: DC 18V: 600Ω maximum DC 24V: 900Ω maximum DC 30V: 1200Ω maximum
Full-Scale Calibration Error	±2% maximum
Offset Calibration Error	±25mA maximum
Accuracy vs. Temperature Error	±100ppm/°C maximum

Analog Current Output Circuit

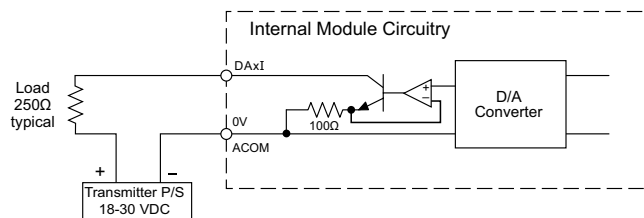

CLICK PLUS Option Slot Module Specifications

General Specifications For All CLICK PLUS Option Slot Modules

These general specifications apply to all CLICK PLUS Option Slot Modules. Please refer to the appropriate I/O temperature derating charts under the Option Slot module and Stackable I/O module specifications to determine the best operating conditions based on the ambient temperature of your particular application.

Option Slot Module General Specifications	
Operating Temperature	32°F to 131°F [0°C to 55°C]
Storage Temperature	-4°F to 158°F [-20°C to 70°C] IEC 60068-2-1 (Test Ab, Cold) IEC 60068-2-2 (Test Bb, Dry Heat) IEC 60068-2-14 (Test Na, Thermal Shock)
Ambient Humidity	30% to 95% relative humidity (non-condensing)
Environmental Air	No corrosive gases. Environmental pollution level is 2 (UL840)
Environment	For Indoor Use Only
Vibration	IEC60068-2-6 (Test Fc) 5-9Hz:3.5mm amplitude, 9-150Hz 1.0G 10 sweep cycles per axis on each of 3 mutually perpendicular axes.
Shock	IEC60068-2-27 (Test Ea) 15G peak, 11ms duration, 3 shocks in each direction per axis, on 3 mutually perpendicular axes.
Noise Immunity	<EN61131-2> EN61000-4-2 (ESD) EN61000-4-3 (RFI) EN61000-4-4 (FTB) EN61000-4-6 (Conducted) EN61000-4-8 (Power frequency magnetic field immunity) <Local Test> Impulse Immunity: 1000V @ 1uS pulse
Emissions	EN55011 Class A (Radiated RF emission)
Agency Approvals	UL61010 (File No. E157382); CE (EN61131-2); CUL Canadian C22.2
Other	RoHS 2011/65/EU Amendment (EU)2015/863

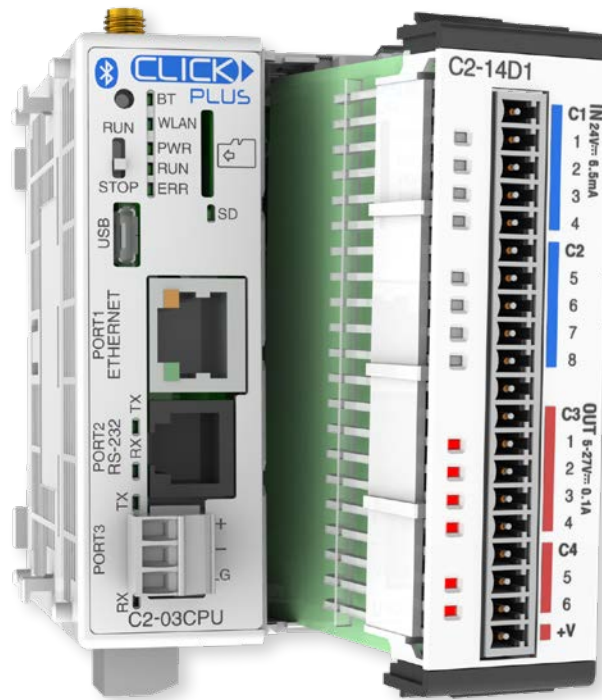

CLICK PLUS PLC Specifications

CLICK PLUS PLC Hardware/Software Compatibility

The table below shows the minimum software and hardware versions required for the CLICK PLUS PLCs and Option Slot Modules. The CLICK PLUS PLC can also utilize the CLICK Stackable I/O Modules, as any software and hardware version compatible with CLICK PLUS is also compatible with the CLICK Stackable I/O Modules.

CLICK PLUS PLC Features Software Compatibility								
Device Type	Part Number	Minimum CLICK Software Version						
		Hardware	High-Speed Inputs*	High-Speed Outputs*	EtherNet/IP	DHCP, DNS	SNTP	PID, MQTT
CLICK PLUS CPU	C2-01CPU	v3.00	v3.00	v3.30	v3.00	v3.00	v3.00	v3.00
	C2-02CPU				N/A			
	C2-03CPU				v3.00			
	C2-01CPU-2	v3.20	v3.20	v3.20	v3.20	v3.20	v3.20	v3.20
	C2-02CPU-2				N/A			
	C2-03CPU-2				v3.20			
Option Slot I/O Modules	C2-14D1	v3.00	v3.00	v3.30	N/A	N/A	N/A	N/A
	C2-14D2							
	C2-14DR							
	C2-14AR	N/A	N/A					
	C2-14TTL	v3.70	v3.70	v3.70				
	C2-08D1-4VC	v3.00	v3.00	v3.30				
	C2-08D2-4VC							
	C2-08DR-4VC							
	C2-08AR-4VC	N/A	N/A					
	C2-08D1-6C	v3.00	v3.00	v3.30				
	C2-08D2-6C							
	C2-08DR-6C							
	C2-08AR-6C	N/A	N/A					
	C2-08D1-6V	v3.00	v3.00	v3.30				
	C2-08D2-6V							
	C2-08DR-6V							
	C2-08AR-6V	N/A	N/A					
	Option Slot Intelligent Modules	C2-DCM	v3.20	N/A				
C2-NRED		v3.70	v3.70					
C2-OPCUA			N/A					

* High-speed Inputs and Outputs are only available when the Option Slot I/O Module is installed in Slot 0.

Power Budgeting

Power Budgeting

There are two factors to consider when determining the power required to operate a CLICK PLC system. The first is the power required by the PLC and internal logic-side power provided through the PLC. This includes the CPU's own I/O, any connected I/O modules that are powered through the PLC expansion port, plus any device, such as a **C-more** Micro-Graphic panel, that is powered through one of the communications ports.

The second area is the power required by all externally-connected I/O devices. This should be viewed as the field-side power required. The field-side power is dependent on the voltage used for a particular input or output device as it relates to the wired I/O point and to the calculated load rating of the connected device.

It is strongly recommended that the power source for the logic side be separate from the power source for the field side to help eliminate possible electrical noise.

Power budgeting requires the calculation of the total current the 24VDC power source needs to provide to CLICK's logic side. A separate calculation is required to determine the total current required for all devices operating from the field side of the PLC system.

Refer to the Power Budgeting example shown on the following page. The table shows required current for a CLICK PLUS PLC, two I/O modules, and a **C-more** Micro. Use the total amperage values to select a suitable power supply.



CLICK 24VDC Power Supply
C0-00AC or C0-01AC



Other 24VDC Power Supply
Example: PSP24-060S

Power Consumption for CLICK and CLICK PLUS PLC Units

Power Consumption for CLICK PLUS Option Slot Modules

PLC Current Consumption (mA)		
Part Number	Power Budget 24VDC (Logic Side)	External 24VDC (Field Side)
Basic PLC Units		
C0-00DD1-D	120	60
C0-00DD2-D	120	0
C0-00DR-D		
C0-00AR-D		
Standard PLC Units		
C0-01DD1-D	140	60
C0-01DD2-D	140	0
C0-01DR-D		
C0-01AR-D		
Analog PLC Units		
C0-02DD1-D	140	60
C0-02DD2-D	140	0
C0-02DR-D		
Ethernet Basic PLC Units		
C0-10DD1E-D	120	60
C0-10DD2E-D	120	0
C0-10DRE-D		
C0-10ARE-D		
Ethernet Standard PLC Units		
C0-11DD1E-D	140	60
C0-11DD2E-D	140	0
C0-11DRE-D		
C0-11ARE-D		

PLC Current Consumption (mA)		
Part Number	Power Budget 24VDC (Logic Side)	External 24VDC (Field Side)
Ethernet Analog PLC Units		
C0-12DD1E-D	140	60
C0-12DD2E-D		
C0-12DRE-D	160	0
C0-12ARE-D		
C0-12DD1E-1-D	140	60
C0-12DD2E-1-D		
C0-12DRE-1-D	160	0
C0-12ARE-1-D		
C0-12DD1E-2-D	140	60
C0-12DD2E-2-D		
C0-12DRE-2-D	160	0
C0-12ARE-2-D		
CLICK PLUS PLCs		
C2-01CPU	110	0
C2-01CPU-2	120	
C2-02CPU	105	
C2-02CPU-2	115	
C2-03CPU	130	
C2-03CPU-2	140	

CLICK PLUS Option Slot Modules Current Consumption (mA)		
Part Number	Power Budget 24VDC (Logic Side)	External 24VDC (Field Side)
Option Slot I/O Modules		
C2-14D1	50	60
C2-14D2	50	0
C2-14DR	75	0
C2-14AR	75	0
C2-14TTL	220	0
C2-08D1-4VC	80	60
C2-08D2-4VC	80	0
C2-08DR-4VC	100	0
C2-08AR-4VC	100	0
C2-08D1-6C	80	60
C2-08D2-6C	80	0
C2-08DR-6C	100	0
C2-08AR-6C	100	0
C2-08D1-6V	80	60
C2-08D2-6V	80	0
C2-08DR-6V	100	0
C2-08AR-6V	100	0
Option Slot Intelligent Modules		
C2-DCM	60	0
C2-NRED	125	0
C2-OPCUA	125	0

Power Budgeting

Power Consumption for CLICK Stackable I/O Modules

I/O Module Current Consumption (mA)		
Part Number	Power Budget 24VDC (logic side)	External 24VDC (field side)
Discrete Input Modules		
C0-08SIM	50	0
C0-08ND3	30	0
C0-08ND3-1	30	0
C0-16ND3	40	0
C0-08NE3	30	0
C0-16NE3	40	0
C0-08NA	30	0
Discrete Output Modules		
C0-08TD1	50	15
C0-08TD2	50	0
C0-16TD1	80	100
C0-16TD2	80	0
C0-08TA	80	0
C0-04TRS	100	0
C0-04TRS-10	120	0
C0-08TR	100	0
C0-08TR-3	90	0

I/O Module Current Consumption (continued) (mA)		
Part Number	Power Budget 24VDC (logic side)	External 24VDC (field side)
Discrete Combo I/O Modules		
C0-16CDD1	80	50
C0-16CDD2	80	0
C0-08CDR	80	0
Analog Input Modules		
C0-04AD-1	20	65
C0-04AD-2	23	65
C0-04POT	30	0
C0-04RTD	25	0
C0-04THM	25	0
Analog Output Modules		
C0-04DA-1	20	145
C0-04DA-2	20	85
Analog Combo I/O Modules		
C0-4AD2DA-1	25	75
C0-4AD2DA-2	20	65
C-more Micro-Graphic Panel		
Monochrome only	90	0

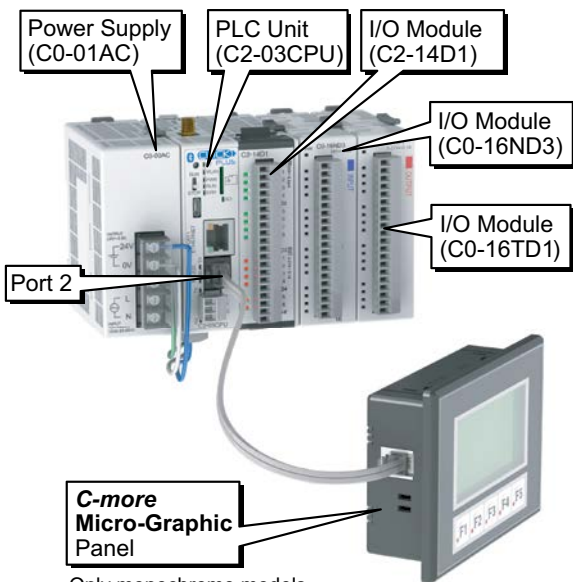
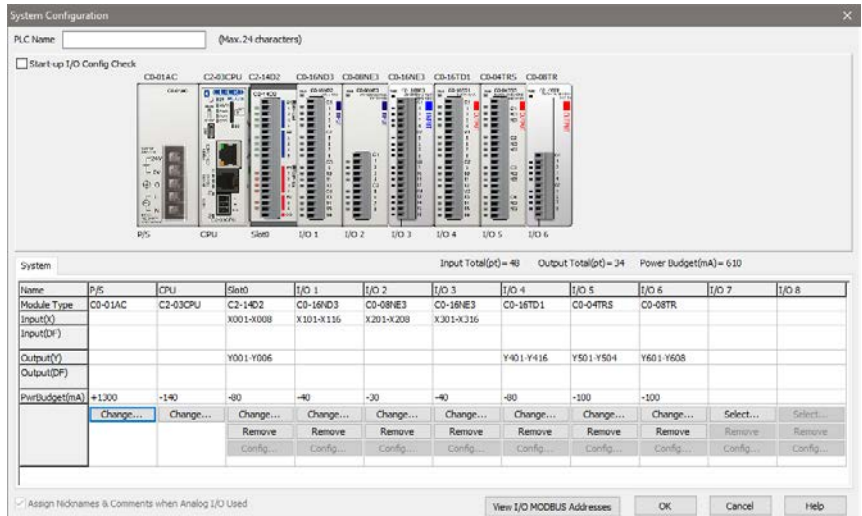

Only monochrome models can be powered from port 2.

Power Budgeting Example

Current Consumption (mA) Example		
Part Number	Power Budget 24VDC (logic side)	External 24VDC (field side)
C2-03CPU	130	0
C2-14D1	50	60
C0-16ND3	40	0
C0-16TD1	80	100
C-more Micro	90	0
Total:	390	160*

* Add in calculated load of connected I/O devices.

Accessories

C2-USER-M **\$0.00** **CLICK PLUS PLC Hardware User Manual**

Manual covers all CLICK PLUS PLC and I/O module installation and wiring, specifications, error codes and troubleshooting guide. The CLICK PLUS PLC Hardware User Manual can be downloaded free at the AutomationDirect Web site; www.AutomationDirect.com



C0-USER-M **\$0.00** **CLICK PLC Hardware User Manual**

Manual covers all CLICK PLC and I/O module installation and wiring, specifications, error codes and troubleshooting guide. The CLICK PLC Hardware User Manual can be downloaded free at the AutomationDirect Web site; www.AutomationDirect.com



C0-PGMSW **\$12.00** **Programming Software USB**

The programming software can be downloaded free at the AutomationDirect Web site, or the USB can be purchased from the AutomationDirect online Web store. www.AutomationDirect.com



EA-MG-PGM-CBL **\$52.00** **PC to Panel Programming Cable Assembly for C-more Micro-Graphic Panels and CLICK/CLICK PLUS PLCs**

The 6-ft cable assembly connects a personal computer to any **C-more** Micro-Graphic panel, CLICK PLC, or select CLICK PLUS PLC for setup and programming.

Note: This cable assembly uses the PC's USB port and converts the signals to serial transmissions. The USB port supplies 5VDC to the Micro-Graphic panel for configuration operations.

Assembly includes standard USB A-type connector to B-type connector cable, custom converter, and an RS232C cable with an RJ12 modular connector on each end.



USB-CBL-AMICB6 **\$5.25** **USB A to USB microB Programming Cable Assembly (CLICK PLUS Only)**

Programming cable, USB A to USB microB, 6ft (1.83 m) length. For use with CLICK PLUS PLCs and most USB devices. The USB port supplies 5VDC to the CLICK PLUS CPU for programming.



D2-DSCBL **\$35.00** **Programming Cable for CLICK/CLICK PLUS and DirectLOGIC PLCs**

12ft. (3.66 m) RS232 shielded PC programming cable for CLICK, select CLICK PLUS PLCs, DL05, DL06, DL105, DL205, D3-350, D4-450, D4-454, and Do-more H2 and T1H series CPUs. 9-pin D-shell female connector to an RJ12 6P6C connector.



Note: If your PC has a USB port but does not have a serial port, you must use programming cable EA-MG-PGM-CBL to connect to CLICK PLCs. For CLICK PLUS PLCs, you may also use USB-CBL-AMICB6

C0-3TB **\$10.00** **Spare 3-Pole Terminal Block**

Replacement 3-pole terminal block for the 3-wire RS-485 Port 3 on CLICK Standard and Analog PLCs as well as the CLICK PLUS C2-03CPU. Sold in packs of 2.



C0-4TB **\$10.00** **Spare 24VDC Power Terminal Block**

Replacement terminal block for the 24VDC supply power to the PLC. Sold in packs of 2.

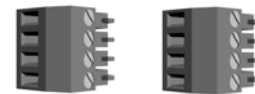

C0-8TB **\$16.50** **Spare 8-Point I/O Terminal Block**

Replacement terminal block for the 8-point I/O modules. Sold in packs of 2.

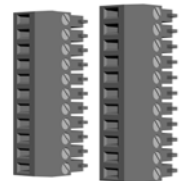

C0-8TB-1 **\$19.50** **Spare 13-Point I/O Terminal Block**

Replacement terminal block for the 8-point I/O relay modules. Sold in packs of 2.



C0-16TB **\$23.00** **Spare 16-Point I/O Terminal Block**

Replacement terminal block for the 16-point I/O modules and PLC built-in I/O. Sold in packs of 2.

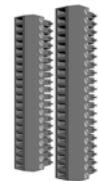

C2-6TB **\$16.50** **Spare 6-pt Terminal Block**

Replacement terminal block for the C2-DCM serial ports. Sold in packs of 2.

