

CLICK PLUS Option Slot Module Specifications

C2-08AR-6V

\$103.00

4 AC Input / 4 Relay Output
4 Analog Voltage Input
2 Analog Voltage Output
Option Slot I/O Module



NOTE: Use this module and a CLICK PLUS CPU as a comparable replacement for the existing C0-12ARE-2-D PLC.

Wiring Diagram

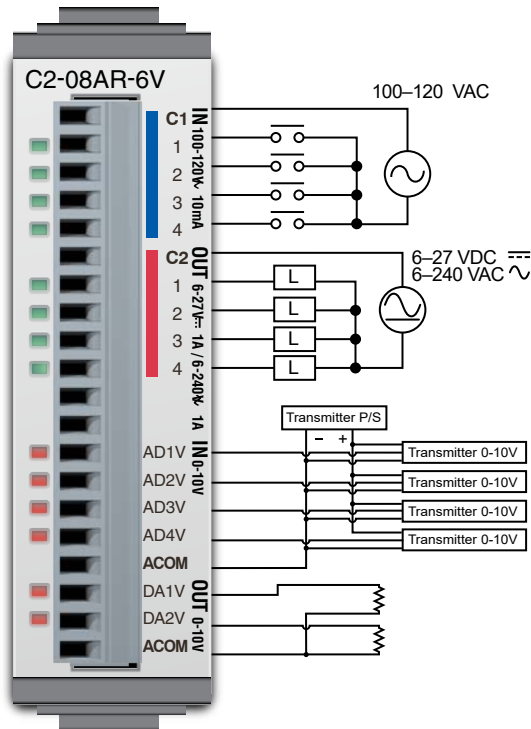

← See Discrete I/O Specifications Inputs (X1 – X4)

← See Discrete I/O Specifications Outputs (Y1 – Y4)

← See Analog I/O Specifications Voltage Inputs (AD1V – AD4V)

← See Analog I/O Specifications Voltage Outputs (DA1V – DA2V)



NOTE: There are no **ZIPLink** pre-wired PLC connection cables and modules for the Analog Option Slot Modules (cannot mix discrete I/O and analog I/O signals in a **ZIPLink** cable).

General Specifications	
Current Consumption at 24VDC	100mA max (All Points On)
Terminal Block Replacement Part No.	C0-16TB
Drawing Link	PDF
Weight	58g

CLICK PLUS Option Slot Module Specifications

C2-08AR-6V (cont'd)

X1 - X4

Discrete I/O Specifications - Inputs	
Inputs per Module	4
Operating Voltage Range	100-120 VAC
AC Frequency	47-63 Hz
Input Current	Typ 8.5 mA @ 100VAC (50Hz) Typ 10mA @100VAC (60Hz)
Max. Input Current	16mA @ 144VAC
Input Impedance	15kΩ @ 50Hz 12kΩ @ 60Hz
ON Voltage Level	> 60VAC
OFF Voltage Level	< 20VAC
Minimum ON Current	5mA
Maximum OFF Current	2mA
OFF to ON Response	< 40ms
ON to OFF Response	< 40ms
Status Indicators	Logic Side (4 points, green LED)
Commons	1 (4 points/common)

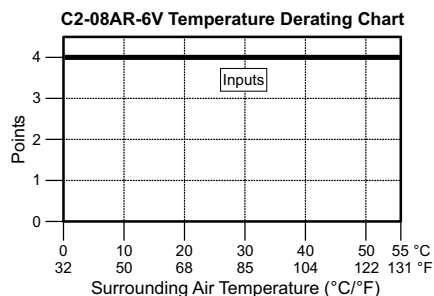
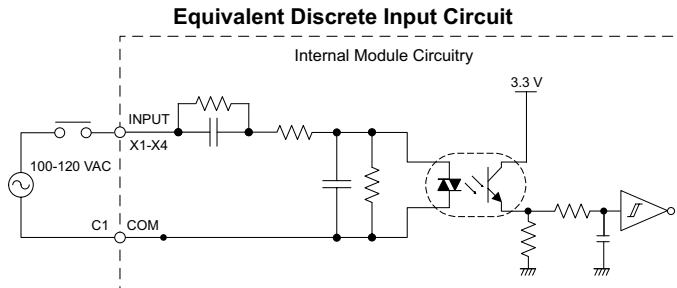

Y1 - Y4

Discrete I/O Specifications - Outputs	
Outputs per Module	4
Operating Voltage Range	6-27 VDC, 6-240 VAC
Output Type	Relay, form A (SPST)
AC Frequency	47-63 Hz
Maximum Current	1A/point (resistive)
Minimum Load Current	5mA @ 5VDC
Maximum Inrush Current	3A for 10ms
OFF to ON Response	< 15ms
ON to OFF Response	< 15ms
Status Indicators	Logic Side (4 points, red LED)
Commons per Module	1 (4 points/common)

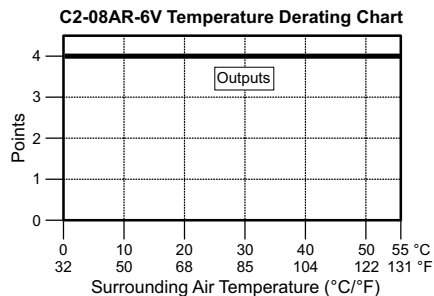
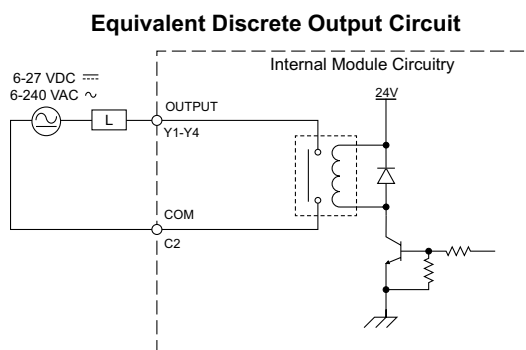

Typical Relay Life (Operations) at Room Temperature	
Voltage & Load Type	Load Current: 1 A
30VDC Resistive	200,000 cycles*
30VDC Inductive	100,000 cycles*
250VAC Resistive	200,000 cycles*
250VAC Inductive	50,000 cycles*

*ON to OFF = 1 cycle

CLICK PLUS Option Slot Module Specifications

C2-08AR-6V (cont'd)

AD1V - AD4V

Analog Specifications - Voltage Input	
Inputs per Module	4 (voltage)
Input Range	0-10 VDC
Resolution	12-bit
Conversion Time	50ms
Input Impedance	40kΩ
Input Stability	±2 LSB maximum
Full-Scale Calibration Error	±2% maximum
Offset Calibration Error	±25mV maximum
Accuracy vs. Temperature Error	±100ppm / °C maximum

Analog Voltage Input Circuit

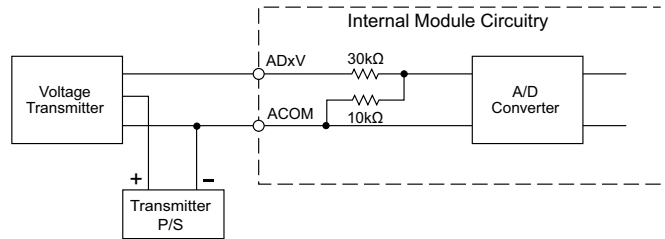

DA1V - DA2V

Analog Specifications - Voltage Output	
Outputs per Module	2 (voltage)
Output Range	0-10 VDC
Resolution	12-bit
Conversion Time	1ms
Load Impedance	4kΩ minimum (output current 2.5 mA maximum)
Full-Scale Calibration Error	±2% maximum
Offset Calibration Error	±25mV maximum
Accuracy vs. Temperature Error	±100ppm / °C maximum

Analog Voltage Output Circuit

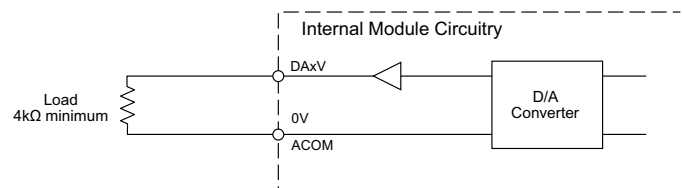

Insulation Requirements for IEC/UL 61010-1 and 61010-2-201 (sections 6.5 and 6.7)

Input to Output Insulation

Basic insulation is provided between the Relay Output and the closest Input terminal. When connecting the Relay Output to a circuit that exceeds 100VAC (141VDC) more than the closest input circuit an additional basic insulation layer must be added to the input circuit.

Additional Basic Insulation Examples

- Supplementary Insulation: Interposing relay, additional insulating material,... (sec. 6.5.3)
- Automatic Disconnection of the Supply: Properly sized breaker (sec. 6.5.5)
- Current or Voltage Limiting device: Properly sized fuse (sec. 6.5.6)

Basic insulation requires a clearance distance of 1.5 mm or more, a creepage distance of 2.5 mm or more, and dielectric voltage withstand of 1500Vrms.

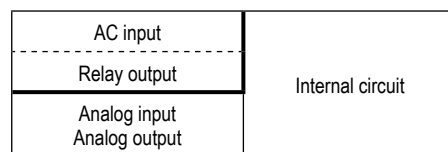

- : No insulation
- - - : Basic insulation
- : Reinforced insulation

CLICK PLUS Option Slot Module Specifications

General Specifications For All CLICK PLUS Option Slot Modules

These general specifications apply to all CLICK PLUS Option Slot Modules. Please refer to the appropriate I/O temperature derating charts under the Option Slot module and Stackable I/O module specifications to determine the best operating conditions based on the ambient temperature of your particular application.

Option Slot Module General Specifications	
Operating Temperature	32°F to 131°F [0°C to 55°C]
Storage Temperature	-4°F to 158°F [-20°C to 70°C] IEC 60068-2-1 (Test Ab, Cold) IEC 60068-2-2 (Test Bb, Dry Heat) IEC 60068-2-14 (Test Na, Thermal Shock)
Ambient Humidity	30% to 95% relative humidity (non-condensing)
Environmental Air	No corrosive gases. Environmental pollution level is 2 (UL840)
Environment	For Indoor Use Only
Vibration	IEC60068-2-6 (Test Fc) 5-9Hz:3.5mm amplitude, 9-150Hz 1.0G 10 sweep cycles per axis on each of 3 mutually perpendicular axes.
Shock	IEC60068-2-27 (Test Ea) 15G peak, 11ms duration, 3 shocks in each direction per axis, on 3 mutually perpendicular axes.
Noise Immunity	<EN61131-2> EN61000-4-2 (ESD) EN61000-4-3 (RFI) EN61000-4-4 (FTB) EN61000-4-6 (Conducted) EN61000-4-8 (Power frequency magnetic field immunity) <Local Test> Impulse Immunity: 1000V @ 1uS pulse
Emissions	EN55011 Class A (Radiated RF emission)
Agency Approvals	UL61010 (File No. E157382); CE (EN61131-2); CUL Canadian C22.2
Other	RoHS 2011/65/EU Amendment (EU)2015/863

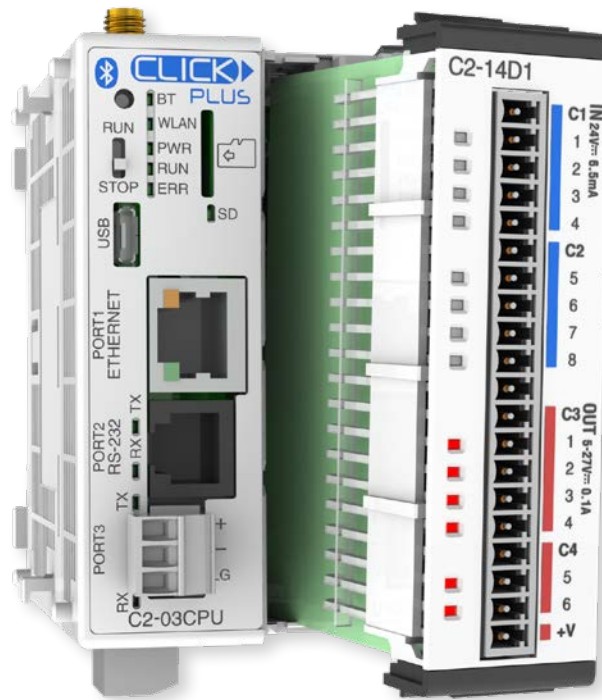

CLICK PLUS PLC Specifications

CLICK PLUS PLC Hardware/Software Compatibility

The table below shows the minimum software and hardware versions required for the CLICK PLUS PLCs and Option Slot Modules. The CLICK PLUS PLC can also utilize the CLICK Stackable I/O Modules, as any software and hardware version compatible with CLICK PLUS is also compatible with the CLICK Stackable I/O Modules.

CLICK PLUS PLC Features Software Compatibility									
Device Type	Part Number	Minimum CLICK Software Version							
		Hardware	High-Speed Inputs*	High-Speed Outputs*	EtherNet/IP	DHCP, DNS	SNTP	PID, MQTT	
CLICK PLUS CPU	C2-01CPU	v3.00	v3.00	v3.30	v3.00	v3.00	v3.00	v3.00	
	C2-02CPU				N/A				
	C2-03CPU				v3.00				
	C2-01CPU-2	v3.20	v3.20	v3.20	v3.20	v3.20	v3.20	v3.20	
	C2-02CPU-2				N/A				
	C2-03CPU-2				v3.20				
Option Slot I/O Modules	C2-14D1	v3.00	v3.00	v3.30	N/A	N/A	N/A	N/A	
	C2-14D2								
	C2-14DR								
	C2-14AR								N/A
	C2-14TTL	v3.70	v3.70	v3.70					
	C2-08D1-4VC	v3.00	v3.00	v3.30					
	C2-08D2-4VC								
	C2-08DR-4VC								N/A
	C2-08AR-4VC								N/A
	C2-08D1-6C	v3.00	v3.00	v3.30					
	C2-08D2-6C								
	C2-08DR-6C								N/A
	C2-08AR-6C								N/A
	C2-08D1-6V	v3.00	v3.00	v3.30					
	C2-08D2-6V								
	C2-08DR-6V								N/A
	C2-08AR-6V								N/A
	Option Slot Intelligent Modules	C2-DCM	v3.20	N/A					N/A
C2-NRED		v3.70	v3.70						
C2-OPCUA			N/A						

* High-speed Inputs and Outputs are only available when the Option Slot I/O Module is installed in Slot 0.

Power Budgeting

Power Budgeting

There are two factors to consider when determining the power required to operate a CLICK PLC system. The first is the power required by the PLC and internal logic-side power provided through the PLC. This includes the CPU's own I/O, any connected I/O modules that are powered through the PLC expansion port, plus any device, such as a **C-more** Micro-Graphic panel, that is powered through one of the communications ports.

The second area is the power required by all externally-connected I/O devices. This should be viewed as the field-side power required. The field-side power is dependent on the voltage used for a particular input or output device as it relates to the wired I/O point and to the calculated load rating of the connected device.

It is strongly recommended that the power source for the logic side be separate from the power source for the field side to help eliminate possible electrical noise.

Power budgeting requires the calculation of the total current the 24VDC power source needs to provide to CLICK's logic side. A separate calculation is required to determine the total current required for all devices operating from the field side of the PLC system.

Refer to the Power Budgeting example shown on the following page. The table shows required current for a CLICK PLUS PLC, two I/O modules, and a **C-more** Micro. Use the total amperage values to select a suitable power supply.



CLICK 24VDC Power Supply
C0-00AC or C0-01AC



Other 24VDC Power Supply
Example: PSP24-060S

Power Consumption for CLICK and CLICK PLUS PLC Units

Power Consumption for CLICK PLUS Option Slot Modules

PLC Current Consumption (mA)		
Part Number	Power Budget 24VDC (Logic Side)	External 24VDC (Field Side)
Basic PLC Units		
C0-00DD1-D	120	60
C0-00DD2-D	120	0
C0-00DR-D		
C0-00AR-D		
Standard PLC Units		
C0-01DD1-D	140	60
C0-01DD2-D	140	0
C0-01DR-D		
C0-01AR-D		
Analog PLC Units		
C0-02DD1-D	140	60
C0-02DD2-D	140	0
C0-02DR-D		
Ethernet Basic PLC Units		
C0-10DD1E-D	120	60
C0-10DD2E-D	120	0
C0-10DRE-D		
C0-10ARE-D		
Ethernet Standard PLC Units		
C0-11DD1E-D	140	60
C0-11DD2E-D	140	0
C0-11DRE-D		
C0-11ARE-D		

PLC Current Consumption (mA)		
Part Number	Power Budget 24VDC (Logic Side)	External 24VDC (Field Side)
Ethernet Analog PLC Units		
C0-12DD1E-D	140	60
C0-12DD2E-D		
C0-12DRE-D	160	0
C0-12ARE-D		
C0-12DD1E-1-D	140	60
C0-12DD2E-1-D		
C0-12DRE-1-D	160	0
C0-12ARE-1-D		
C0-12DD1E-2-D	140	60
C0-12DD2E-2-D		
C0-12DRE-2-D	160	0
C0-12ARE-2-D		
CLICK PLUS PLCs		
C2-01CPU	110	0
C2-01CPU-2	120	
C2-02CPU	105	
C2-02CPU-2	115	
C2-03CPU	130	
C2-03CPU-2	140	

CLICK PLUS Option Slot Modules Current Consumption (mA)		
Part Number	Power Budget 24VDC (Logic Side)	External 24VDC (Field Side)
Option Slot I/O Modules		
C2-14D1	50	60
C2-14D2	50	0
C2-14DR	75	0
C2-14AR	75	0
C2-14TTL	220	0
C2-08D1-4VC	80	60
C2-08D2-4VC	80	0
C2-08DR-4VC	100	0
C2-08AR-4VC	100	0
C2-08D1-6C	80	60
C2-08D2-6C	80	0
C2-08DR-6C	100	0
C2-08AR-6C	100	0
C2-08D1-6V	80	60
C2-08D2-6V	80	0
C2-08DR-6V	100	0
C2-08AR-6V	100	0
Option Slot Intelligent Modules		
C2-DCM	60	0
C2-NRED	125	0
C2-OPCUA	125	0

Power Budgeting

Power Consumption for CLICK Stackable I/O Modules

I/O Module Current Consumption (mA)		
Part Number	Power Budget 24VDC (logic side)	External 24VDC (field side)
Discrete Input Modules		
C0-08SIM	50	0
C0-08ND3	30	0
C0-08ND3-1	30	0
C0-16ND3	40	0
C0-08NE3	30	0
C0-16NE3	40	0
C0-08NA	30	0
Discrete Output Modules		
C0-08TD1	50	15
C0-08TD2	50	0
C0-16TD1	80	100
C0-16TD2	80	0
C0-08TA	80	0
C0-04TRS	100	0
C0-04TRS-10	120	0
C0-08TR	100	0
C0-08TR-3	90	0

I/O Module Current Consumption (continued) (mA)		
Part Number	Power Budget 24VDC (logic side)	External 24VDC (field side)
Discrete Combo I/O Modules		
C0-16CDD1	80	50
C0-16CDD2	80	0
C0-08CDR	80	0
Analog Input Modules		
C0-04AD-1	20	65
C0-04AD-2	23	65
C0-04POT	30	0
C0-04RTD	25	0
C0-04THM	25	0
Analog Output Modules		
C0-04DA-1	20	145
C0-04DA-2	20	85
Analog Combo I/O Modules		
C0-4AD2DA-1	25	75
C0-4AD2DA-2	20	65
C-more Micro-Graphic Panel		
Monochrome only	90	0

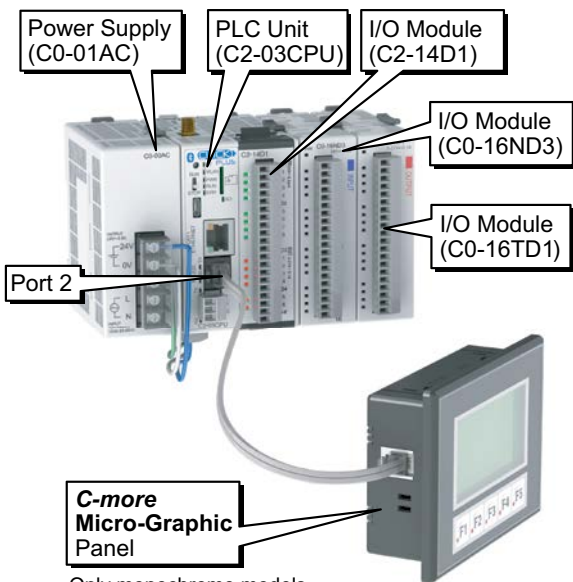
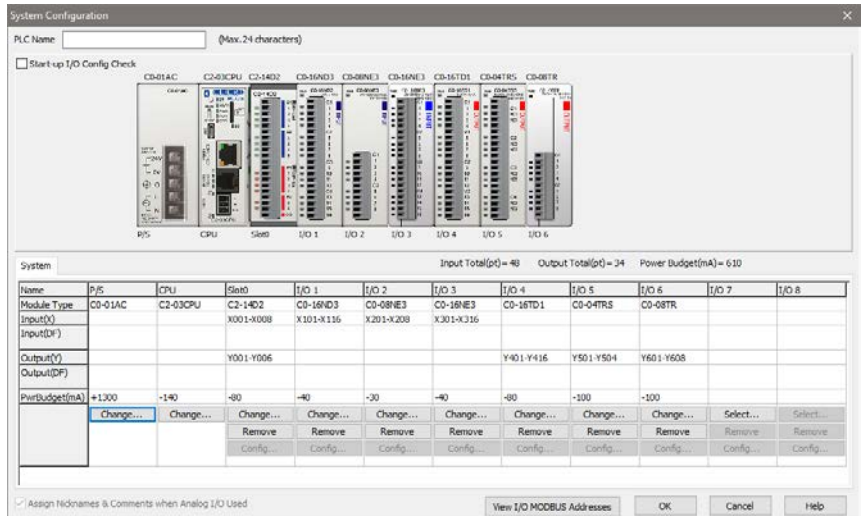

Power Budgeting Example

Current Consumption (mA) Example		
Part Number	Power Budget 24VDC (logic side)	External 24VDC (field side)
C2-03CPU	130	0
C2-14D1	50	60
C0-16ND3	40	0
C0-16TD1	80	100
C-more Micro	90	0
Total:	390	160*

* Add in calculated load of connected I/O devices.

Accessories

C2-USER-M **\$0.00** **CLICK PLUS PLC Hardware User Manual**

Manual covers all CLICK PLUS PLC and I/O module installation and wiring, specifications, error codes and troubleshooting guide. The CLICK PLUS PLC Hardware User Manual can be downloaded free at the AutomationDirect Web site; www.AutomationDirect.com



C0-USER-M **\$0.00** **CLICK PLC Hardware User Manual**

Manual covers all CLICK PLC and I/O module installation and wiring, specifications, error codes and troubleshooting guide. The CLICK PLC Hardware User Manual can be downloaded free at the AutomationDirect Web site; www.AutomationDirect.com



C0-PGMSW **\$12.00** **Programming Software USB**

The programming software can be downloaded free at the AutomationDirect Web site, or the USB can be purchased from the AutomationDirect online Web store. www.AutomationDirect.com



EA-MG-PGM-CBL **\$60.00** **PC to Panel Programming Cable Assembly for C-more Micro-Graphic Panels and CLICK/CLICK PLUS PLCs**

The 6-ft cable assembly connects a personal computer to any **C-more** Micro-Graphic panel, CLICK PLC, or select CLICK PLUS PLC for setup and programming.

Note: This cable assembly uses the PC's USB port and converts the signals to serial transmissions. The USB port supplies 5VDC to the Micro-Graphic panel for configuration operations.

Assembly includes standard USB A-type connector to B-type connector cable, custom converter, and an RS232C cable with an RJ12 modular connector on each end.



USB-CBL-AMICB6 **\$5.75** **USB A to USB microB Programming Cable Assembly (CLICK PLUS Only)**

Programming cable, USB A to USB microB, 6ft (1.83 m) length. For use with CLICK PLUS PLCs and most USB devices. The USB port supplies 5VDC to the CLICK PLUS CPU for programming.



D2-DSCBL **\$41.50** **Programming Cable for CLICK/CLICK PLUS and DirectLOGIC PLCs**

12ft. (3.66 m) RS232 shielded PC programming cable for CLICK, select CLICK PLUS PLCs, DL05, DL06, DL105, DL205, D3-350, D4-450, D4-454, and Do-more H2 and T1H series CPUs. 9-pin D-shell female connector to an RJ12 6P6C connector.



Note: If your PC has a USB port but does not have a serial port, you must use programming cable EA-MG-PGM-CBL to connect to CLICK PLCs. For CLICK PLUS PLCs, you may also use USB-CBL-AMICB6

C0-3TB **\$10.00** **Spare 3-Pole Terminal Block**

Replacement 3-pole terminal block for the 3-wire RS-485 Port 3 on CLICK Standard and Analog PLCs as well as the CLICK PLUS C2-03CPU. Sold in packs of 2.



C0-4TB **\$10.00** **Spare 24VDC Power Terminal Block**

Replacement terminal block for the 24VDC supply power to the PLC. Sold in packs of 2.

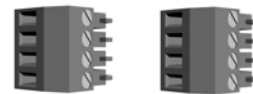

C0-8TB **\$16.50** **Spare 8-Point I/O Terminal Block**

Replacement terminal block for the 8-point I/O modules. Sold in packs of 2.

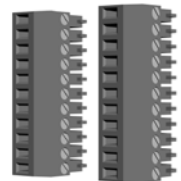

C0-8TB-1 **\$19.50** **Spare 13-Point I/O Terminal Block**

Replacement terminal block for the 8-point I/O relay modules. Sold in packs of 2.



C0-16TB **\$23.00** **Spare 16-Point I/O Terminal Block**

Replacement terminal block for the 16-point I/O modules and PLC built-in I/O. Sold in packs of 2.

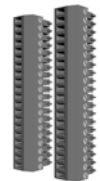

C2-6TB **\$16.50** **Spare 6-pt Terminal Block**

Replacement terminal block for the C2-DCM serial ports. Sold in packs of 2.

