

CLICK Stackable I/O Module Specifications

C0-16CDD2 \$82.00

8-Point DC Input and 8-Point DC Sourcing Output Module

8-point 24VDC current sinking/sourcing input, 1 common, 8-point 12-24 VDC sourcing output, 0.1 A/pt., 1 common, non-fused, removable terminal block included (replacement AutomationDirect p/n C0-16TB).

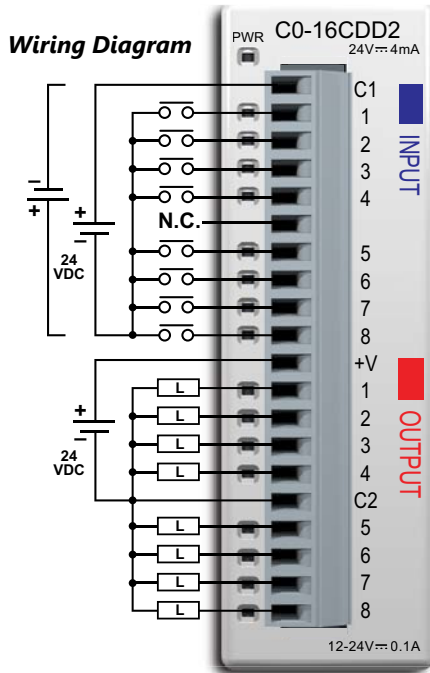

N.C. = Not Connected



NOTE: When using this module you must also use CLICK programming software and PLC firmware version V1.40 or later.

Equivalent Input Circuit

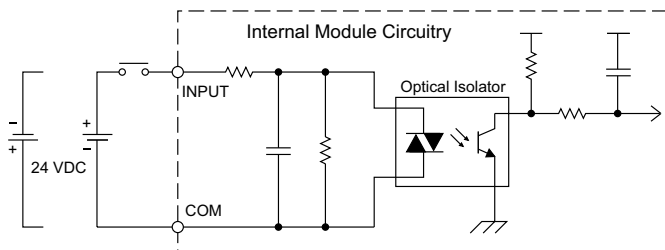

Equivalent Output Circuit

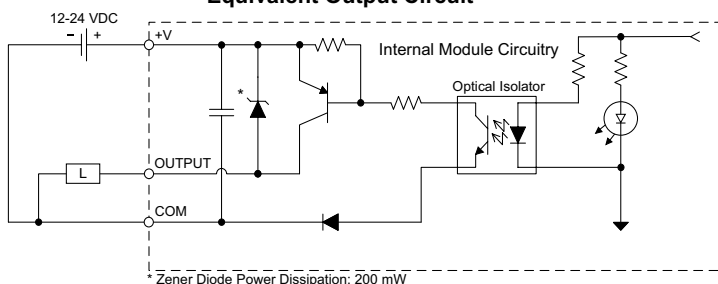

Input Specifications	
Inputs per Module	8 (source/sink)
Operating Voltage Range	CE: 24VDC (-10%/+10%) UL: 24VDC (-10%/+10%)
Input Voltage Range	21.6-26.4 VDC
Input Current	Typ 4.0 mA @ 24VDC
Maximum Input Current	5.0 mA @ 26.4 VDC
Input Impedance	6.8 kΩ @ 24VDC
ON Voltage Level	>19.0 VDC
OFF Voltage Level	<7.0 VDC
Minimum ON Current	3.5 mA
Maximum OFF Current	0.5 mA
OFF to ON Response	Max. 10ms Typ. 2ms
ON to OFF Response	Max. 10ms Typ. 3ms
Status Indicators	Logic Side (8 points, green LED) Power Indicator (green LED)
Commons	1 (8 points/common)

Output Specifications	
Outputs per Module	8 (Source)
Operating Voltage Range	CE: 12-24 VDC (-15%/+20%) UL: 12-24 VDC (-20%/+25%)
Output Voltage Range	9.6-30 VDC
Maximum Output Current	0.1 A / point, 0.8 A / common
Minimum Output Current	0.2 mA
Maximum Leakage Current	0.1 mA @ 30VDC
On Voltage Drop	0.6 VDC @ 0.1 A
Maximum Inrush Current	0.15 A for 10ms
OFF to ON Response	<0.5 ms
ON to OFF Response	<0.5 ms
Status Indicators	Logic Side (8 points, red LED)
Commons	1 (8 points/common)

General Specifications	
Bus Power Required (24VDC)	Max. 80mA (all points on)
Terminal Block Replacement	AutomationDirect p/n C0-16TB
Drawing Link	PDF
Weight	3.2 oz [90g]

Input / Output Temperature Derating Chart

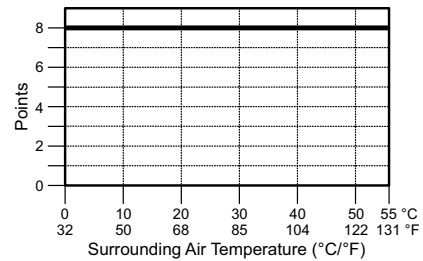

ZIPLink Pre-Wired PLC Connection Cables and Modules for CLICK PLC

ZL-RTB20 20-pin feed-through connector module

20-pin connector cable
ZL-C0-CBL20 (0.5 m length)
ZL-C0-CBL20-1 (1.0 m length)
ZL-C0-CBL20-1 (2.0 m length)



CLICK Stackable I/O Module Specifications

General Specifications For All CLICK Stackable I/O Modules

These general specifications apply to all CLICK Stackable I/O Modules. Please refer to the appropriate I/O temperature derating charts under the PLC (CLICK PLC with built-in I/O), Option Slot module (CLICK PLUS only), and Stackable I/O module specification to determine best operating conditions based on the ambient temperature of your particular application.



NOTE: These modules are available to use with CLICK or CLICK PLUS systems.

General Specifications	
Operating Temperature	Analog, analog combo I/O modules only: 32°F to 140°F [0°C to 60°C]; All other modules: 32°F to 131°F [0°C to 55°C], IEC 60068-2-14 (Test Nb, Thermal Shock)
Storage Temperature	-4°F to 158°F [-20°C to 70°C] IEC 60068-2-1 (Test Ab, Cold) IEC 60068-2-2 (Test Bb, Dry Heat) IEC 60068-2-14 (Test Na, Thermal Shock)
Ambient Humidity	30% to 95% relative humidity (non-condensing)
Environmental Air	No corrosive gases. Environmental pollution level is 2 (UL840)
Vibration	C0-04POT: IEC60068-2-6 (Test Fc) All other modules: MIL STD 810C, Method 514.2, EC60068-2-27, Category [f], Procedure[VIII] JIS C60068-2-27 (Sine wave vibration test)
Shock	MIL STD 810C, Method 516.2, IEC60068-2-27, JIS C60068-2-27, Category [f], Procedure[VIII]
Noise Immunity	<EN61131-2> EN61000-4-2 (ESD) EN61000-4-3 (RFI) EN61000-4-4 (FTB) EN61000-4-5 (Surge) EN61000-4-6 (Conducted) EN61000-4-8 (Power frequency magnetic field immunity) <Local Test> Impulse noise 1µs, 1000V RFI: No interference measured at 150 and 450 MHz (5w/15cm)
Emissions	EN55011:1998 Class A; EN61000-6-4:2007+A1:2011
Agency Approvals	UL508 (excluding C0-04POT), UL61010-2-201 (File No. E157382); CE (EN61131-2); CUL Canadian C22.2
Other	RoHS 2011/65/EU Amendment (EU)2015/863

Power Supplies

Power Supplies

The CLICK PLC family offers two 24VDC power supplies. They are identical except for the output current.

It is not mandatory to use one of these CLICK power supplies for the CLICK/CLICK PLUS PLC system. You can use any other 24VDC power supply that AutomationDirect.com offers, including the PSP24-DC12-1 12 to 24 VDC converter shown below.

CO-00AC Power Supply

Limited auxiliary AC power supply allows you to power the 24VDC CLICK C0 and C2 series PLCs with 100–240 VAC supply power. The 0.5 A DC power supply is capable of controlling the PLC plus a limited configuration based on the power budget of each I/O module. The CO-00AC is a low-cost solution for applications requiring only minimal I/O and power consumption. This power supply will not support a fully-populated CLICK PLC system with all possible I/O module combinations.

CO-01AC Power Supply

Expanded auxiliary AC power supply allows you to power the 24VDC CLICK C0 and C2 series PLCs with 100–240 VAC supply power. The 1.3 A DC power supply is capable of supporting a fully-populated CLICK PLC system with all possible I/O module combinations, with no concerns for exceeding the power budget.

PSP24-DC12-1 DC-DC Converter

With this DC-DC converter you can operate the CLICK/CLICK PLUS PLC with 12VDC input power.

CO-00AC



CO-01AC

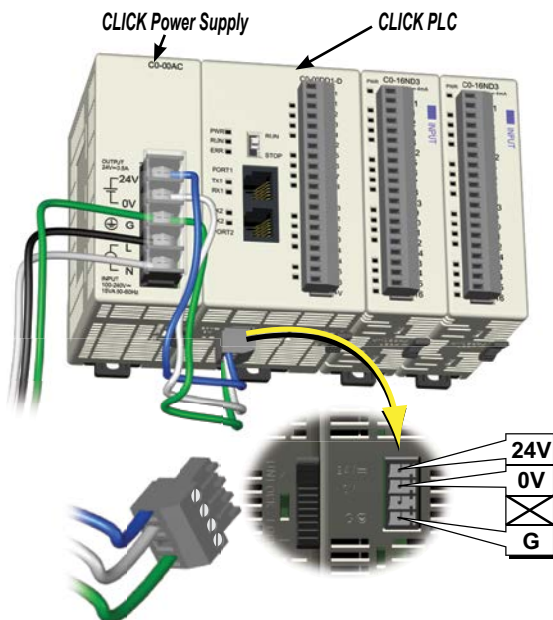

24VDC power is supplied to the PLC unit through wiring connected from the power supply output to the 4-pin 24VDC input connector located on the bottom of the PLC unit.

CLICK 24VDC Power Supply Ratings

Part Number	Output Current	Price
CO-00AC	0.5 A	\$51.00
CO-01AC	1.3 A	\$63.00

Power Supply Input Specifications

Part Number	CO-00AC	CO-01AC
Input Voltage Range	85–264 VAC	
Input Frequency	47–63 Hz	
Input Current (typical)	0.3 A @ 100VAC, 0.2 A @ 200VAC	0.9 A @ 100VAC, 0.6 A @ 200VAC
Inrush Current	30A	
Efficiency	80% typical	

Power Supply Output Specs

Part Number	CO-00AC	CO-01AC
Output Voltage Range	23–25 VDC	
Output Current	0.5 A	1.3 A
Ripple	200mV p-p max (0–55°C)	
Ripple Noise	300mV p-p max (0–55°C)	
Over Current Protection	@ 0.65 A (automatic recovery)	@ 1.6 A (automatic recovery)
Over Voltage Protection	@ 27.6 V (clamped by Zener diode)	
Start-up Time	1000ms max at rated input and load	
Hold-up Time	10ms minimum at 85VAC, I=max	

Power Supply General Specs

Part Number	CO-00AC	CO-01AC
Ambient Operating Temperature	32–131°F [0–55°C]	
Storage Temperature	–4–158°F [–20–70°C]	
Humidity	30–95%, non-condensing	
Vibration Resistance	JIS C60068-2-6, sine wave vibration	
Shock Resistance	JIS C60068-2-27	
Voltage Withstand	1500VAC, 5mA cutoff current	
Input-Output	1500VAC, 5mA cutoff current	
Input-Ground	500VAC, 5mA cutoff current	
Output-Ground	500VAC, 5mA cutoff current	
Insulation Resistance	10MΩ minimum, 500VDC	
Input-Output	10MΩ minimum, 500VDC	
Input-Ground	5MΩ minimum, 500VDC	
Output-Ground	5MΩ minimum, 500VDC	
Noise Immunity	FCC Class A, EN55022:1998 Class A	
Input/Output Interface	5P terminal block, Fujicon UF2362AX series or equivalent	
Agency Approvals	UL508, UL1604, EN61010-1 (IEC 1010-1), CAN/CSA E60079-15:02, JIS C0025	
Drawing Link	PDF	PDF
Weight	5.3 oz [150g]	6.0 oz [170g]



PSP24-DC12-1

PSP24-DC12-1 DC-DC Converter Specs

Input Voltage Range	9.5–18 VDC
Input Power (no load)	1.0 W max.
Startup Voltage	8.4 VDC
Undervoltage Shutdown	7.6 VDC
Output Voltage Range	24–28 VDC (adjustable)
Output Current	1.0 A
Short Circuit Protection	Current limited at 110% typical
Drawing Link	PDF
Weight	7.5 oz [213g]

Power Budgeting

Power Budgeting

There are two factors to consider when determining the power required to operate a CLICK PLC system. The first is the power required by the PLC and internal logic-side power provided through the PLC. This includes the CPU's own I/O, any connected I/O modules that are powered through the PLC expansion port, plus any device, such as a **C-more** Micro-Graphic panel, that is powered through one of the communications ports.

The second area is the power required by all externally-connected I/O devices. This should be viewed as the field-side power required. The field-side power is dependent on the voltage used for a particular input or output device as it relates to the wired I/O point and to the calculated load rating of the connected device.

It is strongly recommended that the power source for the logic side be separate from the power source for the field side to help eliminate possible electrical noise.

Power budgeting requires the calculation of the total current the 24VDC power source needs to provide to CLICK's logic side. A separate calculation is required to determine the total current required for all devices operating from the field side of the PLC system.

Refer to the Power Budgeting example shown on the following page. The table shows required current for a CLICK PLUS PLC, two I/O modules, and a **C-more** Micro. Use the total amperage values to select a suitable power supply.



CLICK 24VDC Power Supply
C0-00AC or C0-01AC



Other 24VDC Power Supply
Example: PSP24-060S

Power Consumption for CLICK and CLICK PLUS PLC Units

Power Consumption for CLICK PLUS Option Slot Modules

PLC Current Consumption (mA)		
Part Number	Power Budget 24VDC (Logic Side)	External 24VDC (Field Side)
Basic PLC Units		
C0-00DD1-D	120	60
C0-00DD2-D	120	0
C0-00DR-D		
C0-00AR-D		
Standard PLC Units		
C0-01DD1-D	140	60
C0-01DD2-D	140	0
C0-01DR-D		
C0-01AR-D		
Analog PLC Units		
C0-02DD1-D	140	60
C0-02DD2-D	140	0
C0-02DR-D		
Ethernet Basic PLC Units		
C0-10DD1E-D	120	60
C0-10DD2E-D	120	0
C0-10DRE-D		
C0-10ARE-D		
Ethernet Standard PLC Units		
C0-11DD1E-D	140	60
C0-11DD2E-D	140	0
C0-11DRE-D		
C0-11ARE-D		

PLC Current Consumption (mA)		
Part Number	Power Budget 24VDC (Logic Side)	External 24VDC (Field Side)
Ethernet Analog PLC Units		
C0-12DD1E-D	140	60
C0-12DD2E-D		
C0-12DRE-D	160	0
C0-12ARE-D		
C0-12DD1E-1-D	140	60
C0-12DD2E-1-D		
C0-12DRE-1-D	160	0
C0-12ARE-1-D		
C0-12DD1E-2-D	140	60
C0-12DD2E-2-D		
C0-12DRE-2-D	160	0
C0-12ARE-2-D		
CLICK PLUS PLCs		
C2-01CPU	110	0
C2-01CPU-2	120	
C2-02CPU	105	
C2-02CPU-2	115	
C2-03CPU	130	
C2-03CPU-2	140	

CLICK PLUS Option Slot Modules Current Consumption (mA)		
Part Number	Power Budget 24VDC (Logic Side)	External 24VDC (Field Side)
Option Slot I/O Modules		
C2-14D1	50	60
C2-14D2	50	0
C2-14DR	75	0
C2-14AR	75	0
C2-14TTL	220	0
C2-08D1-4VC	80	60
C2-08D2-4VC	80	0
C2-08DR-4VC	100	0
C2-08AR-4VC	100	0
C2-08D1-6C	80	60
C2-08D2-6C	80	0
C2-08DR-6C	100	0
C2-08AR-6C	100	0
C2-08D1-6V	80	60
C2-08D2-6V	80	0
C2-08DR-6V	100	0
C2-08AR-6V	100	0
Option Slot Intelligent Modules		
C2-DCM	60	0
C2-NRED	125	0
C2-OPCUA	125	0

Power Budgeting

Power Consumption for CLICK Stackable I/O Modules

I/O Module Current Consumption (mA)		
Part Number	Power Budget 24VDC (logic side)	External 24VDC (field side)
Discrete Input Modules		
C0-08SIM	50	0
C0-08ND3	30	0
C0-08ND3-1	30	0
C0-16ND3	40	0
C0-08NE3	30	0
C0-16NE3	40	0
C0-08NA	30	0
Discrete Output Modules		
C0-08TD1	50	15
C0-08TD2	50	0
C0-16TD1	80	100
C0-16TD2	80	0
C0-08TA	80	0
C0-04TRS	100	0
C0-04TRS-10	120	0
C0-08TR	100	0
C0-08TR-3	90	0

I/O Module Current Consumption (continued) (mA)		
Part Number	Power Budget 24VDC (logic side)	External 24VDC (field side)
Discrete Combo I/O Modules		
C0-16CDD1	80	50
C0-16CDD2	80	0
C0-08CDR	80	0
Analog Input Modules		
C0-04AD-1	20	65
C0-04AD-2	23	65
C0-04POT	30	0
C0-04RTD	25	0
C0-04THM	25	0
Analog Output Modules		
C0-04DA-1	20	145
C0-04DA-2	20	85
Analog Combo I/O Modules		
C0-4AD2DA-1	25	75
C0-4AD2DA-2	20	65
C-more Micro-Graphic Panel		
Monochrome only	90	0

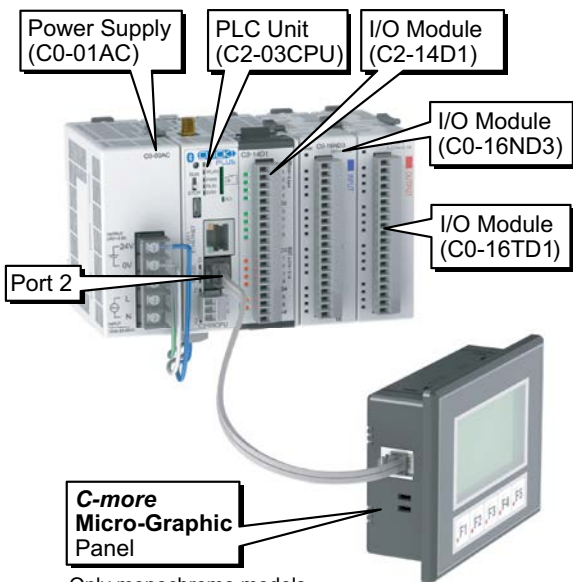
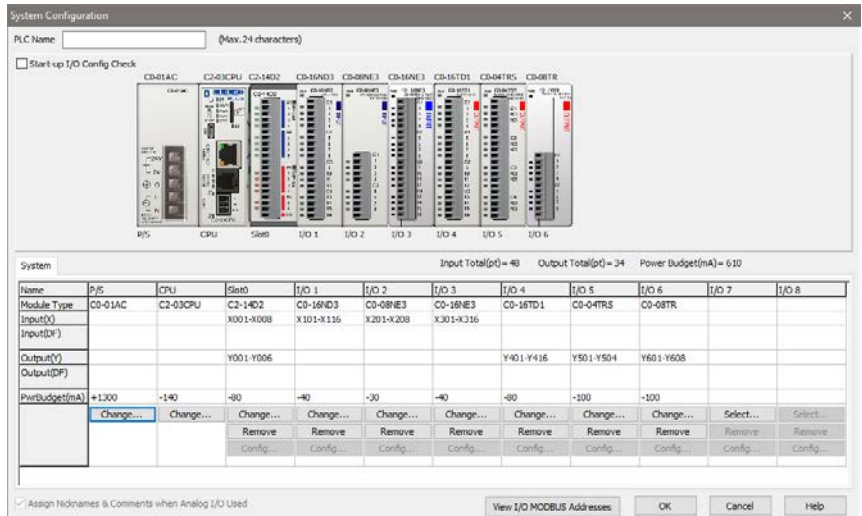

Power Budgeting Example

Current Consumption (mA) Example		
Part Number	Power Budget 24VDC (logic side)	External 24VDC (field side)
C2-03CPU	130	0
C2-14D1	50	60
C0-16ND3	40	0
C0-16TD1	80	100
C-more Micro	90	0
Total:	390	160*

* Add in calculated load of connected I/O devices.

CLICK Specifications

CLICK PLC Hardware/Software Compatibility

CLICK PLCs require a minimum software version of v2.50 for the PID function. The table below shows the most recent software and hardware versions required for the High-Speed input operation capability to be accessible.

CLICK PLC Features Software Compatibility							
CPU Type	Part Number	Minimum CLICK Software Version					
		Hardware	High-Speed Inputs	EtherNet/IP	PID	DHCP	
Basic	C0-00DD1-D	v1.00	N/A	N/A	N/A	N/A	
	C0-00DD2-D						
	C0-00DR-D						
	C0-00AR-D						
Standard	C0-01DD1-D	v1.20	N/A	N/A	N/A	N/A	
	C0-01DD2-D						
	C0-01DR-D						
	C0-01AR-D						
Analog	C0-02DD1-D (before SN 171208001)	v1.12	N/A	N/A	N/A	N/A	
	C0-02DD1-D (after SN 171208001)	v2.10					
	C0-02DD2-D (before SN 174018001)	v1.12					
	C0-02DD2-D (after SN 174018001)	v2.10					
	C0-02DR-D (before SN 173158001)	v1.12					
	C0-02DR-D (after SN 173158001)	v2.10					
Ethernet CPUs	Ethernet CPUs require v2.40 for EtherNet/IP communications						
Ethernet Basic	C0-10DD1E-D	v2.00	v2.30	v2.40	v2.50	v3.00	
	C0-10DD2E-D						
	C0-10DRE-D		N/A				
	C0-10ARE-D						
Ethernet Standard	C0-11DD1E-D	v2.00	v2.30	v2.40	v2.50	v3.00	
	C0-11DD2E-D						
	C0-11DRE-D		N/A				
	C0-11ARE-D						
Ethernet Analog	C0-12DD1E-D	v2.20	v2.30	v2.40	v2.50	v3.00	
	C0-12DD2E-D						
	C0-12DRE-D		N/A				
	C0-12ARE-D						
	C0-12DD1E-1-D		v2.30				
	C0-12DD2E-1-D						
	C0-12DRE-1-D		N/A				
	C0-12ARE-1-D						
	C0-12DD1E-2-D		v2.30				
	C0-12DD2E-2-D						
	C0-12DRE-2-D		N/A				
	C0-12ARE-2-D						
I/O Modules	C0-08NE3	v1.20	N/A	N/A	N/A	N/A	
	C0-16NE3						
	C0-04AD-1	v1.40					
	C0-04AD-2						
	C0-04DA-1						
	C0-04DA-2						
	C0-4AD2DA-1						
	C0-4AD2DA-2						
	C0-04RTD						
	C0-04THM						
	C0-08CDR						
	C0-16CDD1						
	C0-16CDD2						
	C0-04POT						v3.70
	Other modules						v1.00



Wiring System for CLICK PLC Family

Wiring Solutions using the ZIPLink Wiring System

ZIPLinks eliminate the normally tedious process of wiring between devices by utilizing prewired cables and DIN rail mount connector modules. It's as simple as plugging in a cable connector at either end or terminating wires at only one end. Prewired cables keep installation clean and efficient, using half the space at a fraction of the cost of standard terminal blocks.



ZIPLinks are available in a variety of styles to suit your needs, including feedthrough connector module. **ZIPLinks** are available for all Basic, Standard and Ethernet CLICK PLC units, select CLICK PLUS option slot modules, and most discrete and analog stackable I/O modules. Pre-printed I/O-specific adhesive label strips for quick marking of **ZIPLink** modules are provided with **ZIPLink** cables.

Solution 1: CLICK PLC, CLICK PLUS PLC with Option Slot Module, and Stackable I/O Modules to ZIPLink Connector Modules

When looking for quick and easy I/O-to-field termination, a **ZIPLink** connector module used in conjunction with a prewired **ZIPLink** cable, consisting of an I/O terminal block at one end and a multi-pin connector at the other end, is the best solution.

Use the "CLICK PLC Unit **ZIPLink** Selector" table and CLICK I/O **ZIPLink** selector tables located in this section:

- Locate your PLC or I/O module.
- Select a **ZIPLink** Module.
- Select a corresponding **ZIPLink** Cable.

Solution 2: CLICK/CLICK PLUS PLC I/O to 3rd Party Devices

When wanting to connect PLC I/O (built-in, option slot module, or stackable) to another device within close proximity, no extra terminal blocks are necessary when using the **ZIPLink** Pigtail Cables. **ZIPLink** Pigtail Cables are prewired to an I/O terminal block with color-coded pigtail with soldered-tip wires on the other end.

Use the I/O Modules to 3rd Party Devices selector tables located in the **ZIPLink** section:

- Locate your PLC or I/O module.
- Select a **ZIPLink** Pigtail Cable that is compatible with your 3rd party device



Solution 3: GS Series and DuraPulse Drives Communication Cables

Need to communicate via Modbus RTU to a drive or a network of drives?

ZIPLink cables are available in a wide range of configurations for connecting to PLCs and SureServo, SureStep, Stellar Soft Starter and AC drives. Add a **ZIPLink** communications module to quickly and easily set up a multi-device network.

Use the Drives Communication selector tables located in the **ZIPLink** section:

- Locate your Drive and type of communications.
- Select a **ZIPLink** cable and other associated hardware.



Solution 4: Serial Communications Cables

ZIPLink offers communications cables for use with CLICK PLCs and select CLICK PLUS PLCs that can also be used with other communications devices. Connections include a 6-pin RJ12 connector which can be used in conjunction with the RJ12 Feedthrough module.

Use the Serial Communications Cables selector table located in the **ZIPLink** section:

- Locate your connector type
- Select a cable.





Wiring System for CLICK PLC Family

CLICK PLC & CLICK PLUS Option Slot ZIPLink Selector					
PLC or Option Slot Module			ZIPLink		
CLICK PLC Unit	CLICK PLUS Option Slot Module	# of Terms	Component	Module Part No.	Cable Part No.
C0-00DD1-D	NA	20	Feedthrough	ZL-RTB20, ZL-RTB20-1	ZL-C0-CBL20 *
C0-00DD2-D	NA				
C0-00DR-D	NA				
C0-00AR-D	NA				
C0-01DD1-D	NA				
C0-01DD2-D	NA				
C0-01DR-D	NA				
C0-01AR-D	NA				
C0-02DD1-D	NA				
C0-02DD2-D	NA				
No ZIPLinks are available for CLICK Analog PLC units.					
C0-10DD1E-D	NA	20	Feedthrough	ZL-RTB20, ZL-RTB20-1	ZL-C0-CBL20 *
C0-10DD2E-D	NA				
C0-10DRE-D	NA				
C0-10ARE-D	NA				
C0-11DD1E-D	C2-14D1				
C0-11DD2E-D	C2-14D2				
C0-11DRE-D	C2-14DR				
C0-11ARE-D	C2-14AR				
NA	C2-14TTL				
C0-12DD1E-D	C2-08D1-4VC				
No ZIPLinks are available for CLICK Ethernet Analog PLC units or CLICK PLUS Option Slot Modules with analog I/O.					
C0-12DD2E-D	C2-08D2-4VC	20	Feedthrough	ZL-RTB20, ZL-RTB20-1	ZL-C0-CBL20 *
C0-12DRE-D	C2-08DR-4VC				
C0-12ARE-D	C2-08AR-4VC				
C0-12DD1E-1-D	C2-08D1-6C				
C0-12DD2E-1-D	C2-08D2-6C				
C0-12DRE-1-D	C2-08DR-6C				
C0-12ARE-1-D	C2-08AR-6C				
C0-12DD1E-2-D	C2-08D1-6V				
C0-12DD2E-2-D	C2-08D2-6V				
C0-12DRE-2-D	C2-08DR-6V				
C0-12ARE-2-D	C2-08AR-6V				
NA	C2-DCM	20	Feedthrough	ZL-RTB20, ZL-RTB20-1	ZL-C0-CBL20 *
NA	C2-NRED				
NA	C2-OPCUA				
No ZIPLinks are available for CLICK PLUS Option Slot Communications Module					

Table Notes:

* Select the cable length by replacing the * with: Blank = 0.5 m, -1 = 1.0 m, or -2 = 2.0 m.

1 Note: The C0-04TRS relay output is derated not to exceed 2A per point maximum when used with the ZIPLink wiring system.

2 Note: Fuses (5x20 mm) are not included. See Edison Electronic Fuse section for 5x20 mm fuse. S500 and GMA electronic circuit protection is recommended for fast-acting maximum protection. S506 and GMC electronic circuit protection is recommended for time-delay performance. Ideal for inductive circuits. To ensure proper operation, do not exceed the voltage and current rating of the ZIPLink module. ZL-RFU20 = 2A per circuit.

CLICK/CLICK PLUS PLC Discrete Input Module ZIPLink Selector				
I/O Module		ZIPLink		
Input Module	# of Terms	Component	Module Part No.	Cable Part No.
C0-08SIM	Not supported by ZIPLink			
C0-08ND3	11	Feedthrough	ZL-RTB20	ZL-C0-CBL11 *
C0-08ND3-1				
C0-08NE3				
C0-08NA				
C0-16ND3	20	Feedthrough	ZL-RTB20	ZL-C0-CBL20 *
		Sensor	ZL-LTB16-24-1	
C0-16NE3	20	Feedthrough	ZL-RTB20	
		Sensor	ZL-LTB16-24-1	

CLICK/CLICK PLUS PLC Discrete Output Module ZIPLink Selector				
I/O Module		ZIPLink		
Output Module	# of Terms	Component	Module Part No.	Cable Part No.
C0-08TD1	11	Feedthrough	ZL-RTB20	ZL-C0-CBL11 *
C0-08TD2				
C0-08TR				
C0-08TR-3	Not supported by ZIPLink			
C0-08TA				
C0-16TD1	20	Feedthrough	ZL-RTB20	ZL-C0-CBL20*
		Fuse	ZL-RFU20 2	
		Relay (sinking)	ZL-RRL16-24-1	
C0-16TD2	20	Feedthrough	ZL-RTB20	ZL-C0-CBL20*
		Fuse	ZL-RFU20 2	
		Relay (sourcing)	ZL-RRL16-24-2	
C0-04TRS1	20	Feedthrough	ZL-RTB20	ZL-C0-CBL20*
C0-04TRS-10	Not supported by ZIPLink			

CLICK/CLICK PLUS PLC Combo I/O Module ZIPLink Selector				
I/O Module		ZIPLink		
Combo Module	# of Terms	Component	Module Part No.	Cable Part No.
C0-16CDD1	20	Feedthrough	ZL-RTB20	ZL-C0-CBL20 *
C0-16CDD2				
C0-08CDR	11	Feedthrough	ZL-RTB20	ZL-C0-CBL11 *

CLICK/CLICK PLUS PLC Analog I/O Module ZIPLink Selector				
I/O Module		ZIPLink		
Analog Module	# of Terms	Component	Module Part No.	Cable Part No.
C0-04AD-1	11	Feedthrough	ZL-RTB20	ZL-C0-CBL11 *
C0-04AD-2	11	Feedthrough	ZL-RTB20	ZL-C0-CBL11 *
C0-04POT	0	No ZIPLinks are available for RTD and thermocouple modules.		
C0-04RTD	20			
C0-04THM	11			
C0-04DA-1	11	Feedthrough	ZL-RTB20	ZL-C0-CBL11 *
C0-04DA-2	11	Feedthrough	ZL-RTB20	ZL-C0-CBL11 *
C0-4AD2DA-1	20	Feedthrough	ZL-RTB20	ZL-C0-CBL20 *
C0-4AD2DA-2	20	Feedthrough	ZL-RTB20	ZL-C0-CBL20 *