

Achieve™ Wire Duct - Slotted

Rigid PVC - Open Slot - Narrow Finger Wall WDN Series

Overview

Rugged wire duct is made of a rigid PVC that carries a UL 94 V-0 flammability rating for your wire containment needs. All WDN series wire duct comes in lengths of 6.56 ft [2m], complete with cover.

Features

- Additional holes on the sidewalls to be used with cable tie
- Flame-retardant PVC material, self-extinguishing according to UL 94 V-0
- Upper and lower score lines for breaking off individual fingers
- Open slot narrow finger form factor
- Cover included
- Standard length: 6.56 ft [2m]
- Color option: RAL 7030 Stone Gray
- Complies with RoHS regulations
- Complies with EN 50085-2-3 standards and UL 1565 and C22.2 No.18.5-02 standards
- Operating temperature range -5 to 50°C [23 to 122°F]



WDN-1530G-1



Gray Rigid PVC - Open Slot - Narrow Finger Wall - WDN Series						
Part Number	Qty	Price	Actual Size [W x H] inches [mm]	Dimension A inches [mm]	Dimension B inches [mm]	Drawing Link
WDN-1015G-1	1	\$12.00	1.00 x 1.57 [25 x 40]	0.16 [4]	0.24 [6]	PDF
WDN-1022G-1	1	\$12.00	1.00 x 2.36 [25 x 60]			PDF
WDN-1030G-1	1	\$15.00	1.00 x 3.15 [25 x 80]			PDF
WDN-1515G-1	1	\$13.00	1.57 x 1.57 [40 x 40]			PDF
WDN-1522G-1	1	\$14.00	1.57 x 2.36 [40 x 60]			PDF
WDN-1530G-1	1	\$17.00	1.57 x 3.15 [40 x 80]			PDF
WDN-1540G-1	1	\$20.00	1.57 x 3.94 [40 x 100]			PDF
WDN-2215G-1	1	\$14.00	2.36 x 1.57 [60 x 40]			PDF
WDN-2222G-1	1	\$14.00	2.36 x 2.36 [60 x 60]			PDF
WDN-2230G-1	1	\$18.00	2.36 x 3.15 [60 x 80]			PDF
WDN-2240G-1	1	\$20.00	2.36 x 3.94 [60 x 100]			PDF
WDN-3015G-1	1	\$18.00	3.15 x 1.57 [80 x 40]			PDF
WDN-3022G-1	1	\$19.00	3.15 x 2.36 [80 x 60]			PDF
WDN-3030G-1	1	\$22.00	3.15 x 3.15 [80 x 80]			PDF
WDN-3040G-1	1	\$24.00	3.15 x 3.94 [80 x 100]			PDF
WDN-4022G-1	1	\$21.00	3.94 x 2.36 [100 x 60]			PDF
WDN-4030G-1	1	\$24.00	3.94 x 3.15 [100 x 80]			PDF
WDN-4040G-1	1	\$29.00	3.94 x 3.94 [100 x 100]			PDF

Cover included.

Dimensions

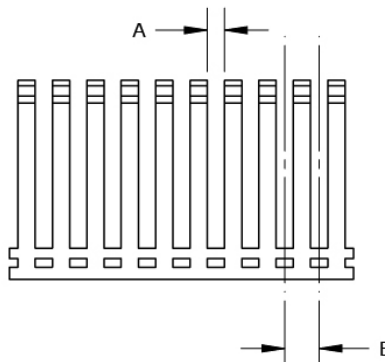
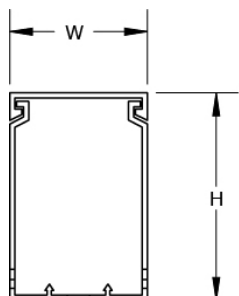

Achieve™ Wire Duct - Slotted

Wire Fill Capacity

Rigid PVC - Open Slot - Narrow Finger Wall - WDN Series																			
Application	Electrical															Communication			
Conductor Size	8 AWG	10 AWG	12 AWG			14 AWG			16 AWG			18 AWG			22 AWG	23 AWG	23/24 AWG	24 AWG	Fiber Cable
Wire/Cable	0.22"	0.16"	0.13"	0.14"	0.15"	0.11"	0.12"	0.13"	0.10"	0.11"	0.12"	0.08"	0.10"	0.11"	0.08"	0.33"	0.25"	0.19"	0.12"
Insulation Type	THHN	THHN	THHN	MTW	MTW	THHN	MTW	MTW	TFFN	MTW	MTW	TFFN	MTW	MTW	MTW	Cat. 6A	Cat. 6	Cat. 5E	3.0 mm
Duct Size Inches [mm]	Recommended Maximum Number of Wires/Cables per Wire Duct (based on 50% fill capacity)																		
WDN-1015G-1 1.00 x 1.57 [25x40]	18	31	50	43	37	69	55	48	93	69	61	121	85	76	118	7	13	23	61
WDN-1022G-1 1.00 x 2.36 [25x60]	27	47	76	65	56	104	83	72	140	104	92	182	128	114	178	11	20	35	92
WDN-1030G-1 1.00 x 3.15 [25x80]	36	63	101	86	74	139	111	96	186	139	123	242	171	152	237	15	27	47	122
WDN-1515G-1 1.57 x 1.57 [40x40]	27	47	76	64	55	104	83	72	139	104	92	182	128	114	177	11	20	35	92
WDN-1522G-1 1.57 x 2.36 [40x60]	41	71	114	97	83	156	125	108	209	156	138	272	192	171	267	17	30	53	137
WDN-1530G-1 1.57 x 3.15 [40x80]	55	95	152	129	111	208	167	145	279	208	184	364	257	228	355	23	41	71	184
WDN-1540G-1 1.57 x 3.94 [40x100]	73	127	202	172	148	278	222	193	372	278	246	485	342	305	474	31	54	94	245
WDN-2215G-1 2.36 x 1.57 [60x40]	41	71	114	97	83	156	125	108	209	156	138	272	192	171	267	17	30	53	137
WDN-2222G-1 2.36 x 2.36 [60x60]	62	107	170	145	125	235	187	163	314	235	208	409	289	257	400	26	46	79	207
WDN-2230G-1 2.36 x 3.15 [60x80]	82	143	227	194	167	313	250	217	419	313	277	546	385	343	533	35	61	106	276
WDN-2240G-1 2.36 x 3.94 [60x10]	108	189	303	258	222	417	333	288	558	417	369	726	513	456	711	45	81	141	366
WDN-3015G-1 3.15 x 1.57 [80x40]	55	95	152	129	111	208	167	145	279	208	184	364	257	228	355	23	41	71	184
WDN-3022G-1 3.15 x 2.36 [80x60]	82	143	227	194	167	313	250	217	419	313	277	546	385	343	533	35	61	106	276
WDN-3030G-1 3.15 x 3.15 [80x80]	108	189	303	258	222	417	333	288	558	417	369	726	513	456	711	45	81	141	366
WDN-3040G-1 3.15 x 3.94 [80x100]	144	252	404	344	296	556	444	384	744	556	492	968	684	608	948	60	108	188	488
WDN-4022G-1 3.94 x 2.36 [100x60]	108	189	303	258	222	417	333	288	558	417	369	726	513	456	711	45	81	141	366
WDN-4030G-1 3.94 x 3.15 [100x80]	144	252	404	344	296	556	444	384	744	556	492	968	684	608	948	60	108	188	488
WDN-4040G-1 3.94 x 3.94 [100x100]	192	336	539	459	395	741	592	512	992	741	656	1291	912	811	1264	80	144	251	651

Cover included.

Achieve™ Wire Duct - Slotted

Rigid PVC - Open Slot - Narrow Finger Wall WDN Series and Wide Finger Wall WDW Series

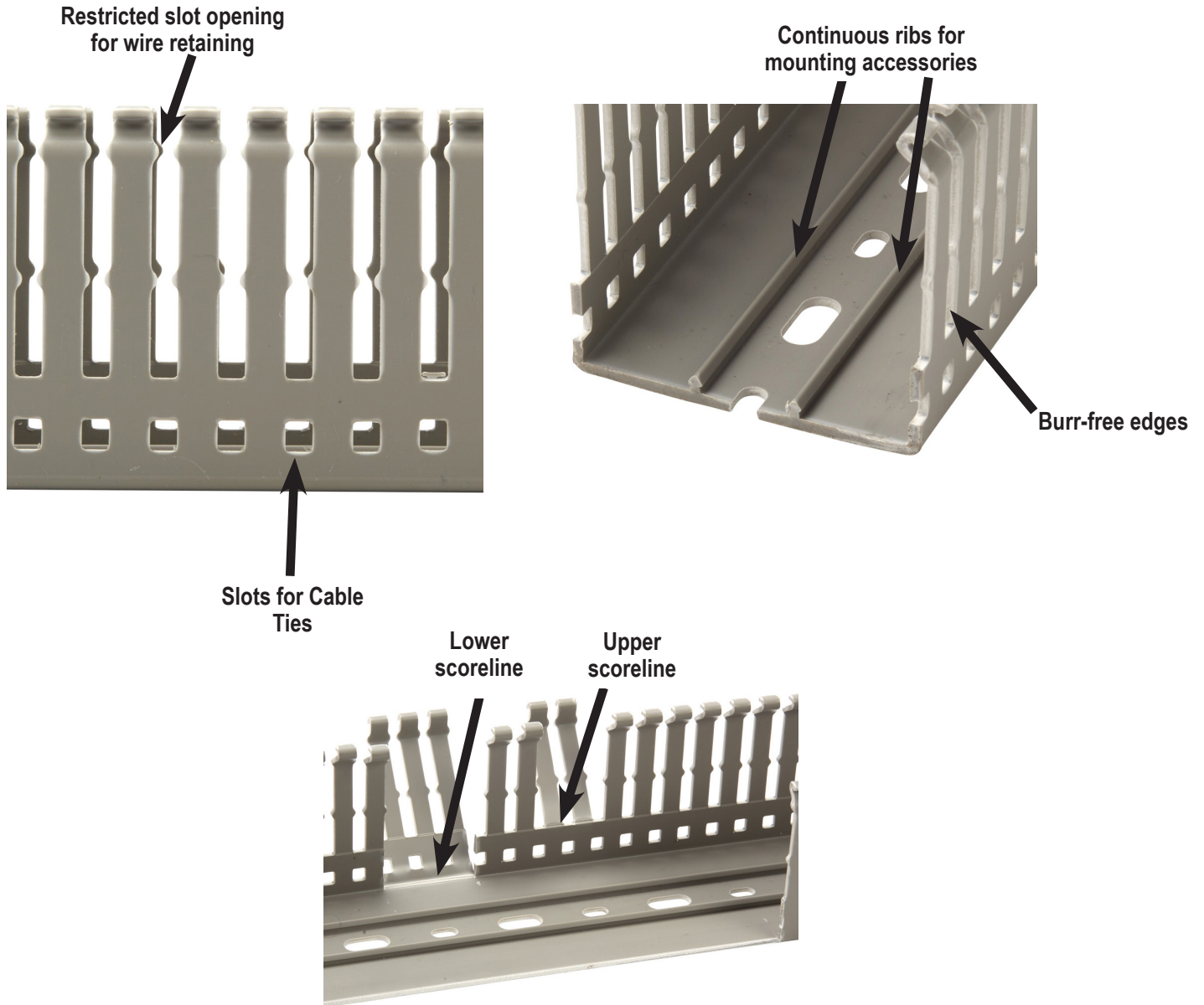

AchieVe™ Wire Duct - Accessories

Cable Tie Attachment

Overview

The AchieVe cable tie attachment is for use along with a cable tie to group wires together inside the wire duct. The **WD-CTCLAMP** snaps onto either of the continuous ribs and can be easily repositioned once installed.



Features

- Material: Polyamid (PA), flammability rating of UL94 V-2
- Operating Temperature Range: -55 to 120°C [-67 to 248°F]
- CE



Cable Tie Attachment					
Part Number	Price	Description	Color	Qty	Drawing Link
WD-CTCLAMP	\$9.00	AchieVe cable tie attachment for use with AchieVe wire duct 1.5" width or larger.	Black	50	PDF

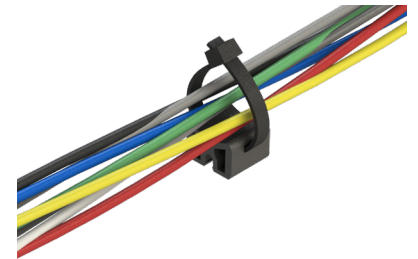

Dimensions inches [mm]

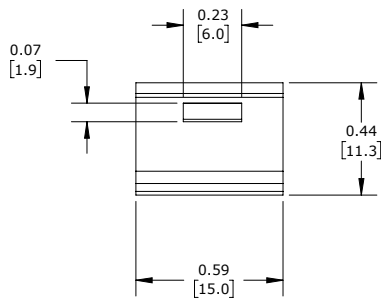

Wire Retainers

Overview

For holding wires during wiring operations, these retainers are essential. They allow easy access to the interior of the wire duct during maintenance or alterations, or for isolating specific wires/cables, while assuring that wiring bundles will not fall out when the duct cover is removed. Installed by snapping into the two continuous ribs on the inside bottom face of the wire duct.



Features

- Material: Polyamid (PA), flammability rating of UL94 V-2
- Operating Temperature Range: -40 to 120°C [-40 to 248°F]
- CE



Wire Retainers					
Part Number	Price	Description	Color	Qty	Drawing Link
WD-RET-1515	\$8.00	AchieVe wire retainer for use with AchieVe wire duct 1.5 x 1.5 in or larger.	Black	10	PDF
WD-RET-1522	\$9.00	AchieVe wire retainer for use with AchieVe wire duct 1.5 x 2.25 in or larger.	Black	10	PDF
WD-RET-2230	\$12.00	AchieVe wire retainer for use with AchieVe wire duct 2.25 x 3.0 in or larger.	Black	10	PDF

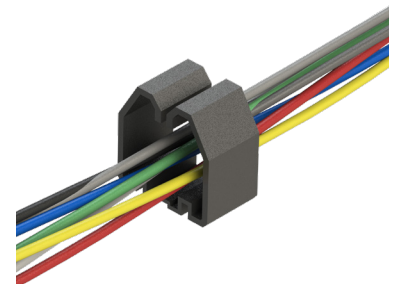

AchieVe™ Wire Duct - Accessories

Wire Separator

Overview

The AchieVe wire separator easily clips onto wire duct fingers and is used to separate wires within the duct. Score lines to break off for compatibility with multiple wire duct widths adjustable for 1.5" or larger width duct.



Features

- Material: Polyamid (PA), flammability rating of UL94 V-2
- Operating Temperature Range: -55 to 120°C [-67 to 248°F]
- CE



Wire Separator					
Part Number	Price	Description	Color	Qty	Drawing Link
WD-CHOLDER	\$4.00	AchieVe wire separator for use with AchieVe wire duct 1.5" width or larger.	Black	10	PDF

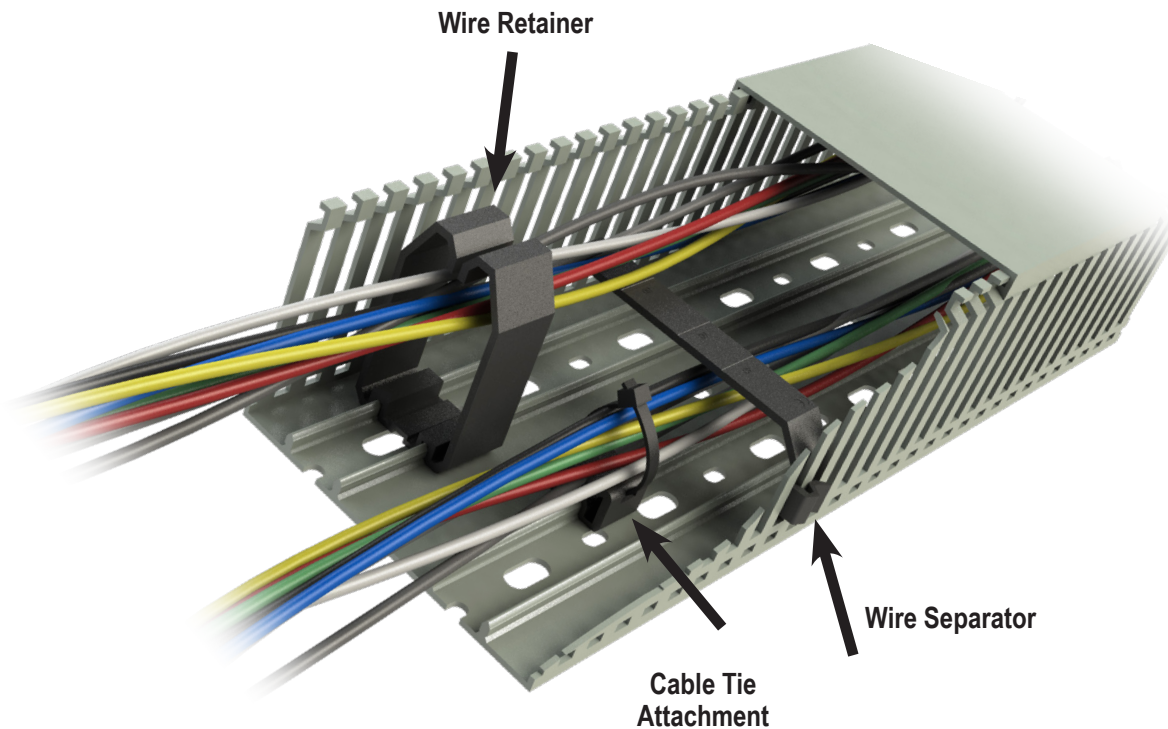

Wire Duct - Accessories

Rivets and Rivet Tools

Wire duct rivets install quickly and easily with the companion rivet tool, offering good temperature resistance and excellent mechanical properties. They can be used to install all types of wire duct with standard mounting holes.

Wire Duct Rivets and Rivet Tools			
Part Number	Price	Description	Qty
R4*	\$19.00	Blue polyamide rivet used to install all types of wire duct with standard 4.5 mm [0.17 in] mounting holes.	250
B4	\$50.00	Red polyamide rivet tool used to install R4 rivets.	1
R6*	\$22.00	Natural polyamide rivet used to install all types of wire duct with standard 6.5 mm [0.26 in] mounting holes.	250
B6	\$50.00	Yellow polyamide rivet tool used to install R6 rivets.	1

* R4 drill hole size - 5/32" (4mm), R6 drill hole size - 7/32" [5.5 mm]

